

Surface Modeling portfolio with Illustration in Solidworks.

By:
Mahendranathan R

mahen1978@gmail.com

[Linked-in](#)



mahen1978@gmail.com



mahen1978@gmail.com



mahen1978@gmail.com

Surface Modeling portfolio with Illustration in Solidworks.



mahen1978@gmail.com

Surface Modeling portfolio with Illustration in Solidworks.

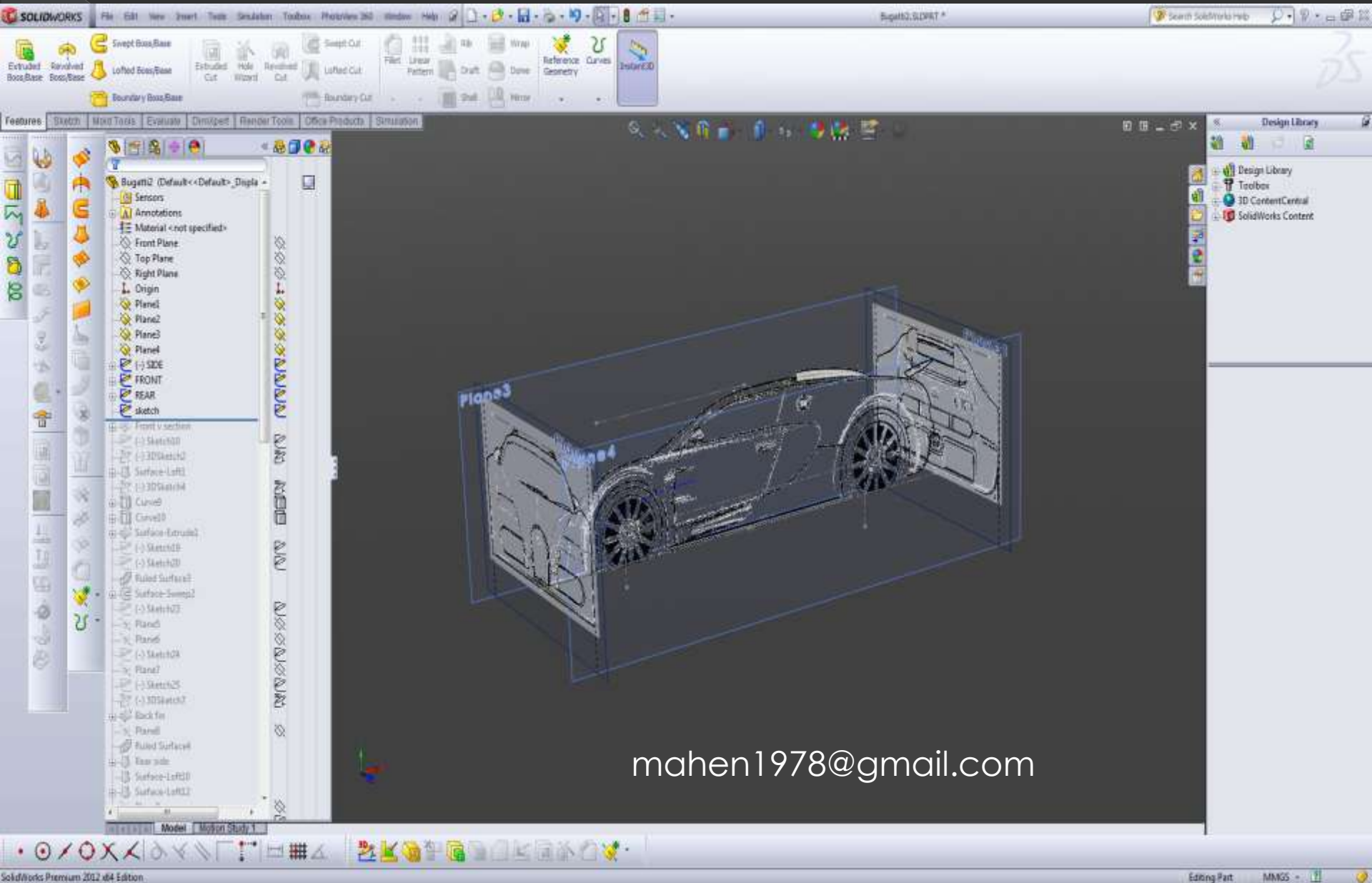

Surface Modeling portfolio with Illustration in Solidworks.

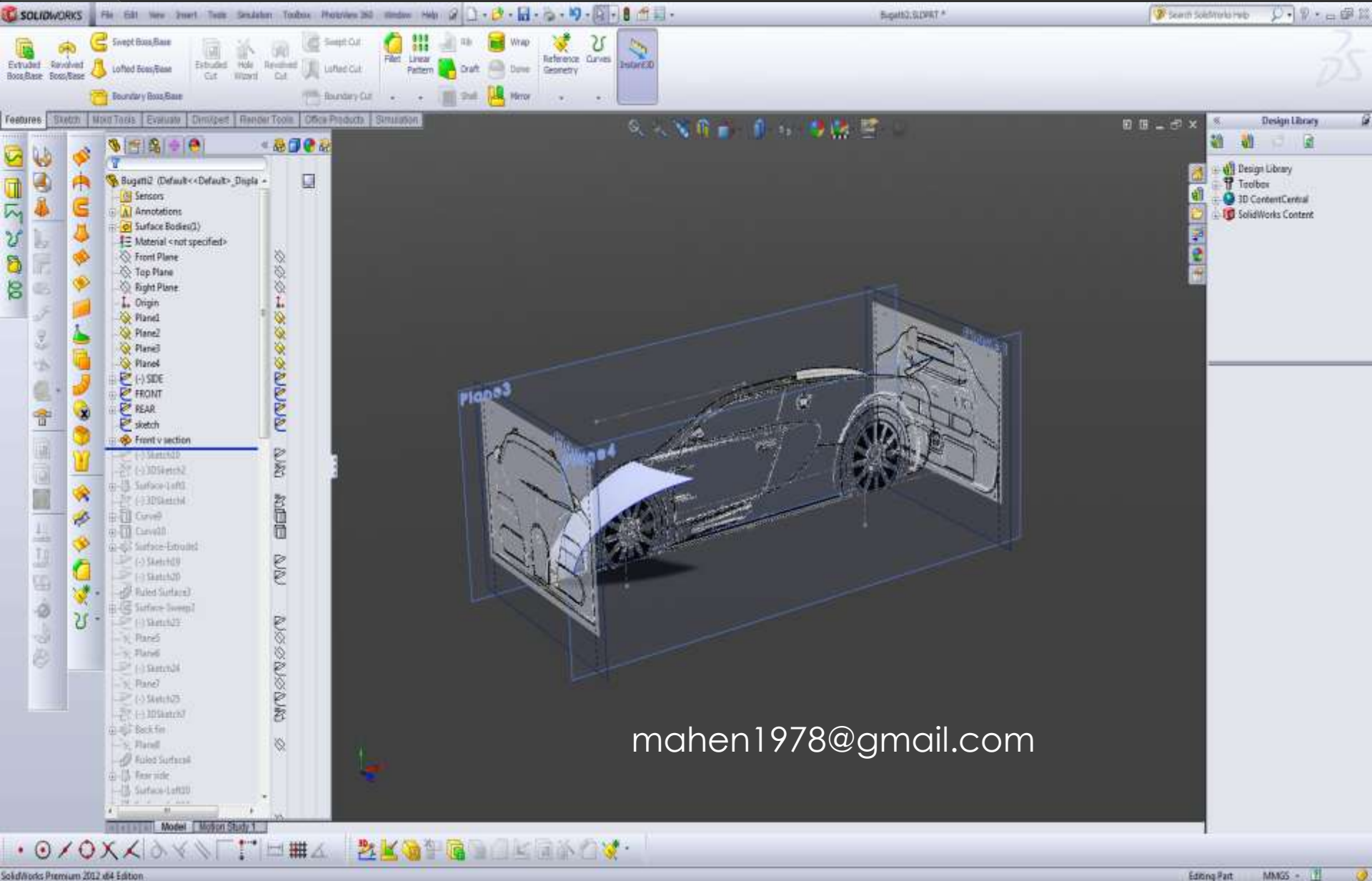

Surface Modeling portfolio with Illustration in Solidworks.

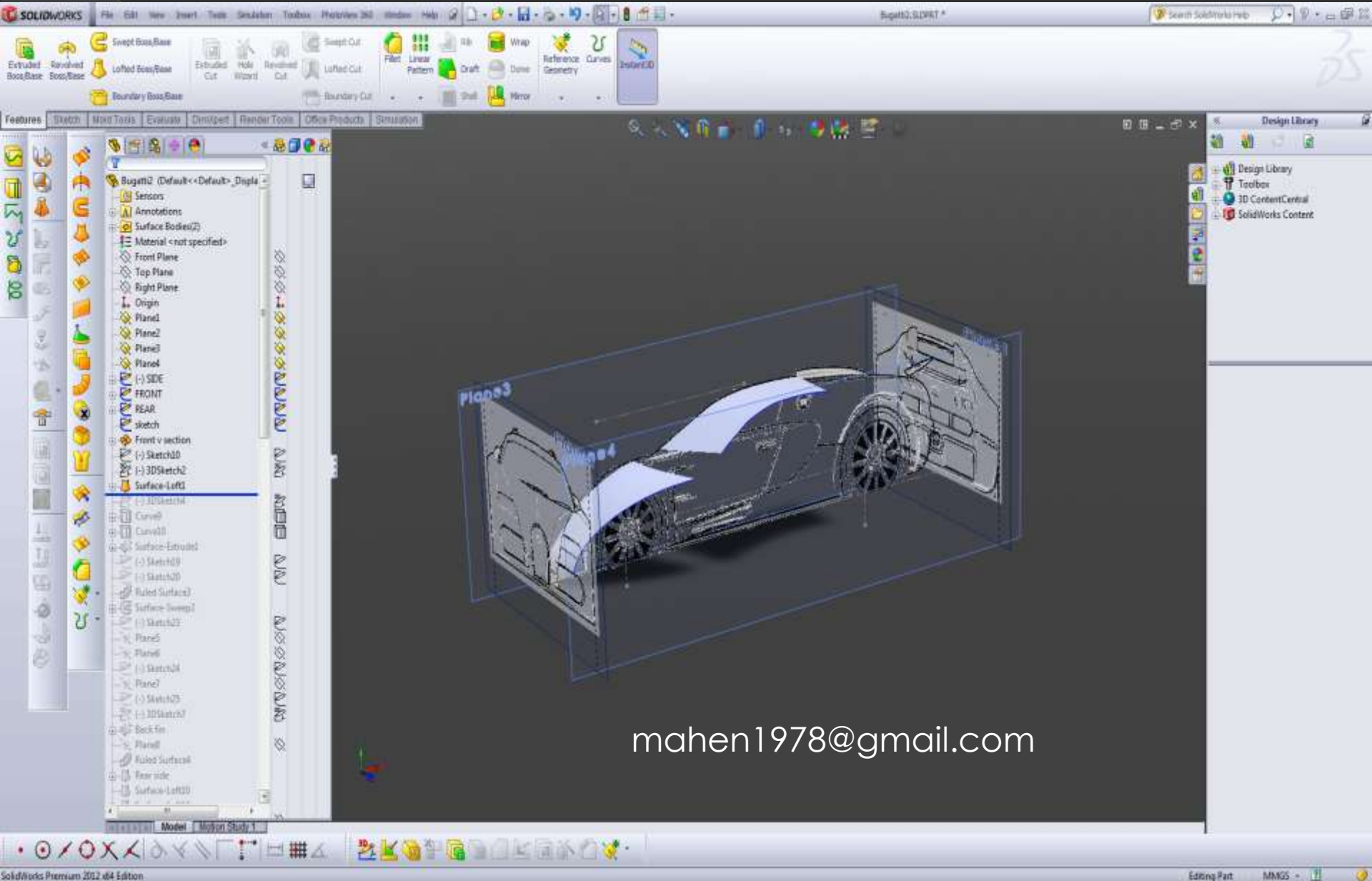

mahen1978@gmail.com

Surface Modeling portfolio with Illustration in Solidworks.

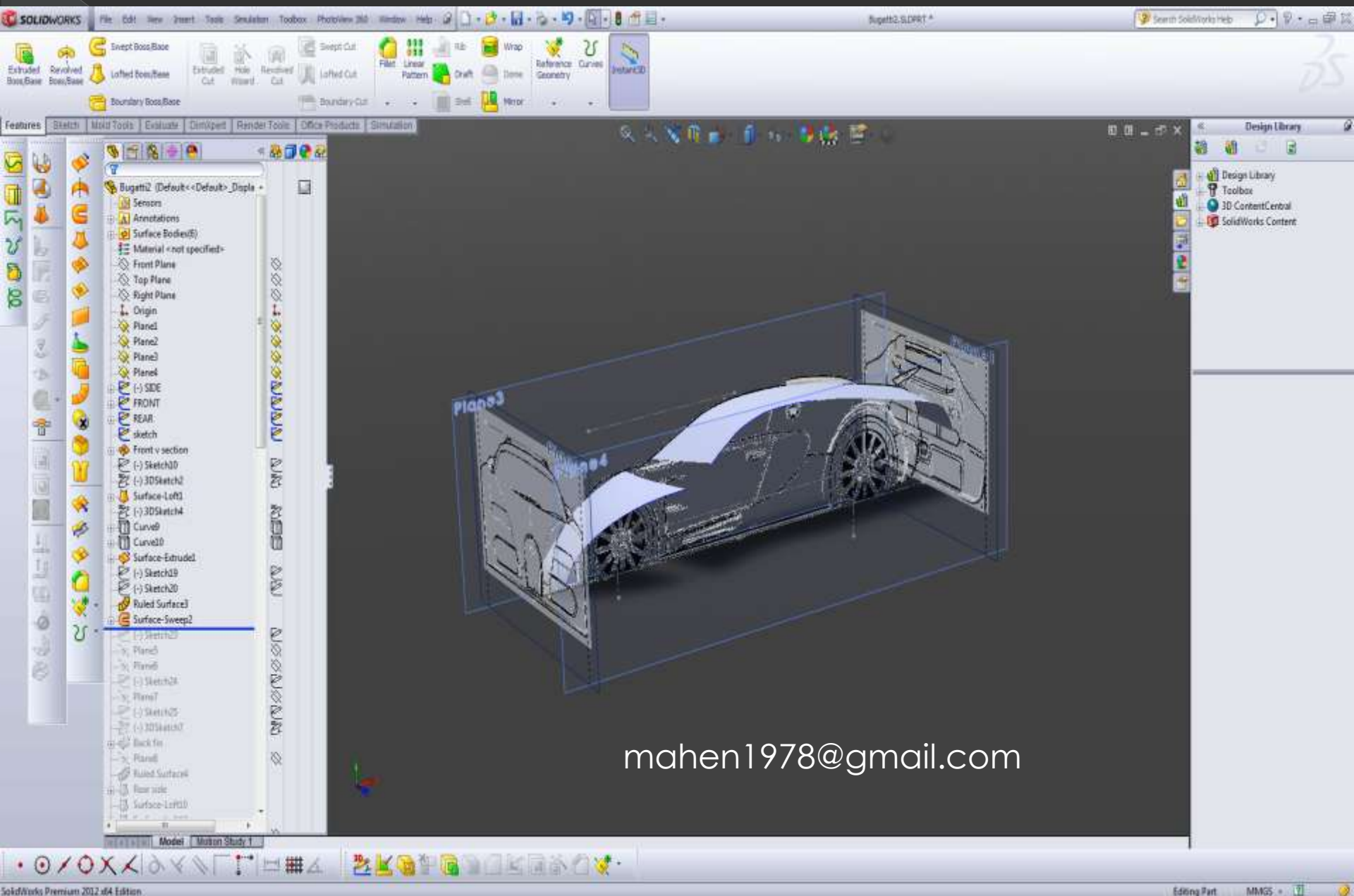

mahen1978@gmail.com

Surface Modeling portfolio with Illustration in Solidworks.

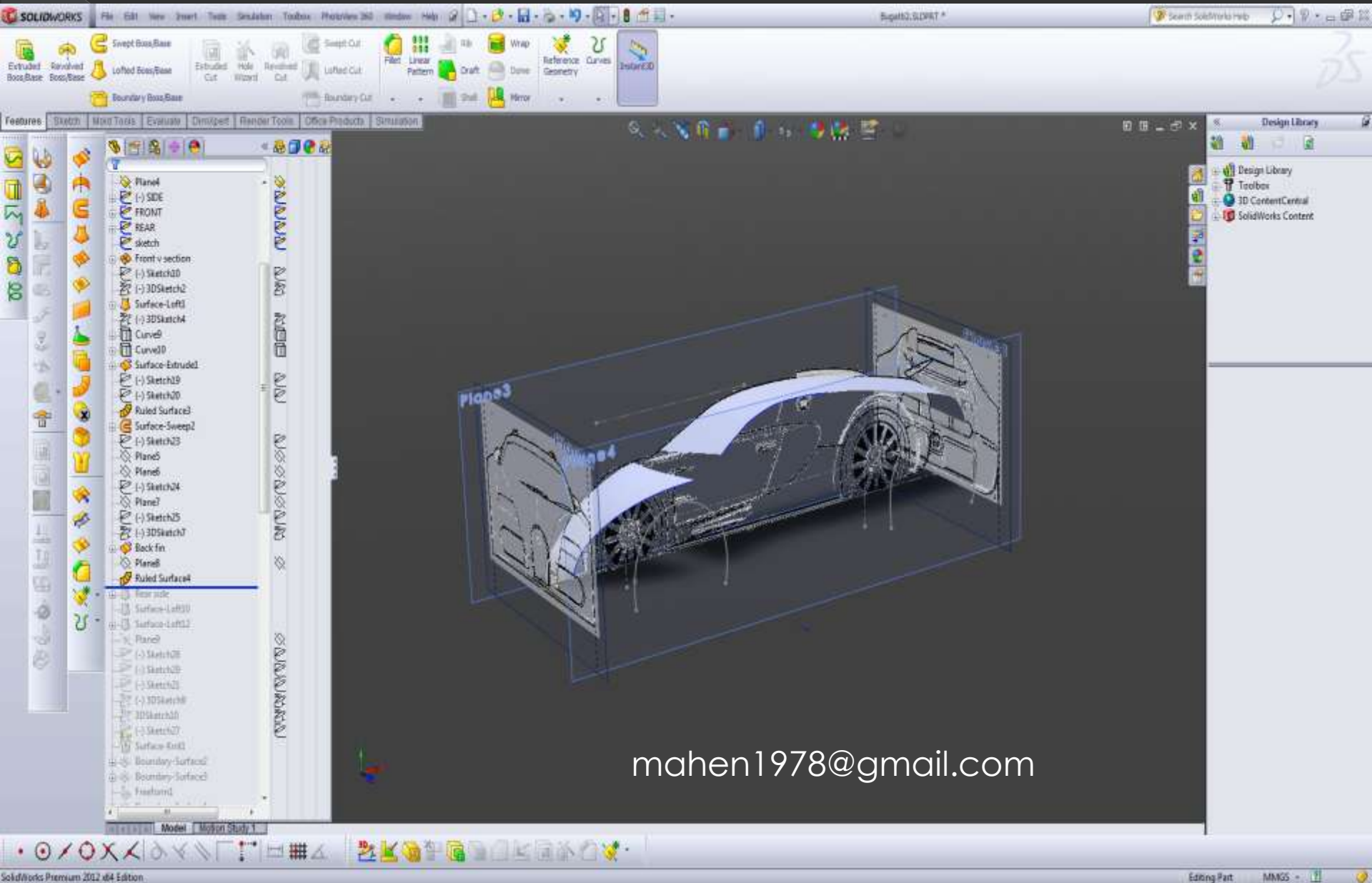

mahen1978@gmail.com

Surface Modeling portfolio with Illustration in Solidworks.

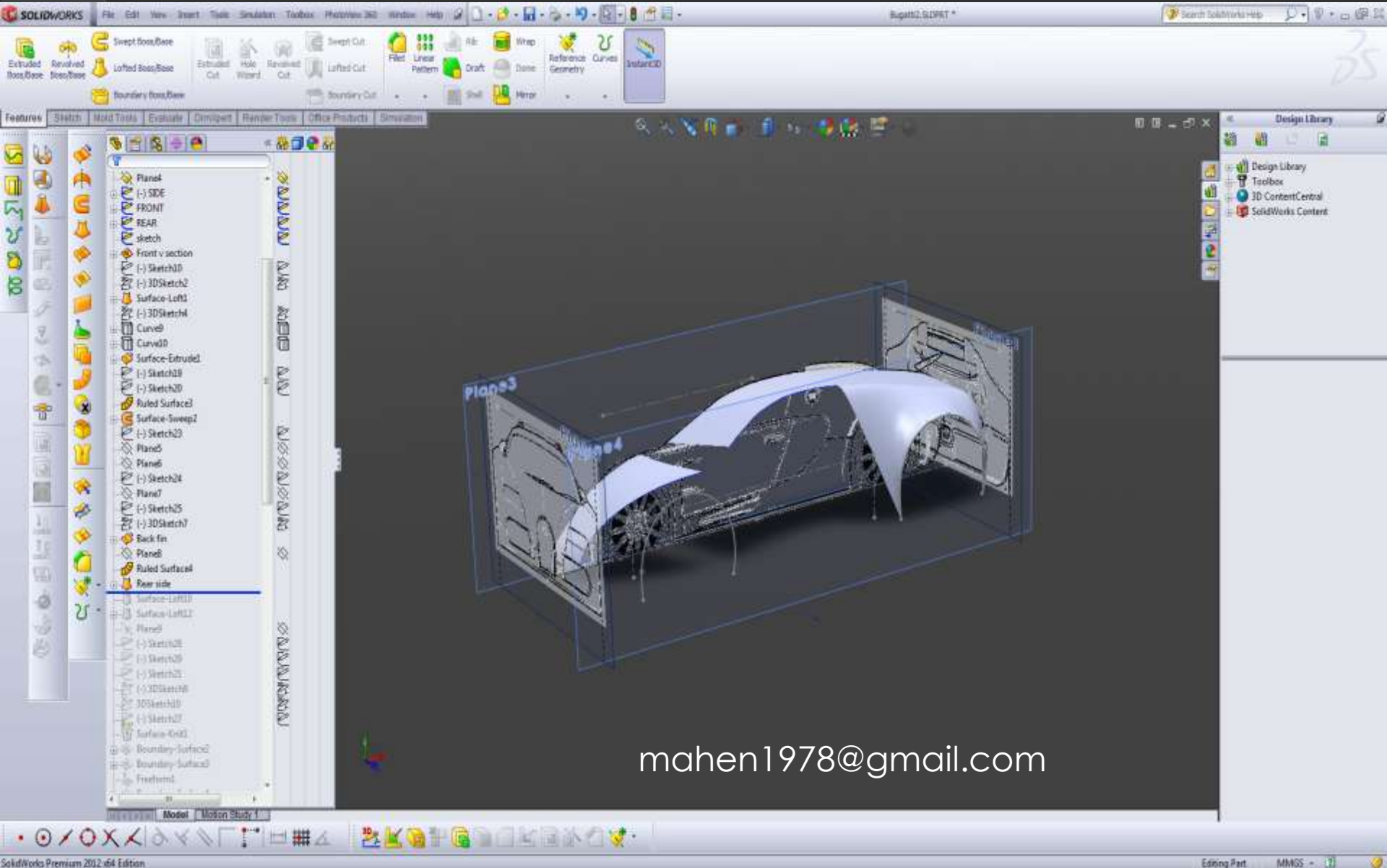

mahen1978@gmail.com

Surface Modeling portfolio with Illustration in Solidworks.

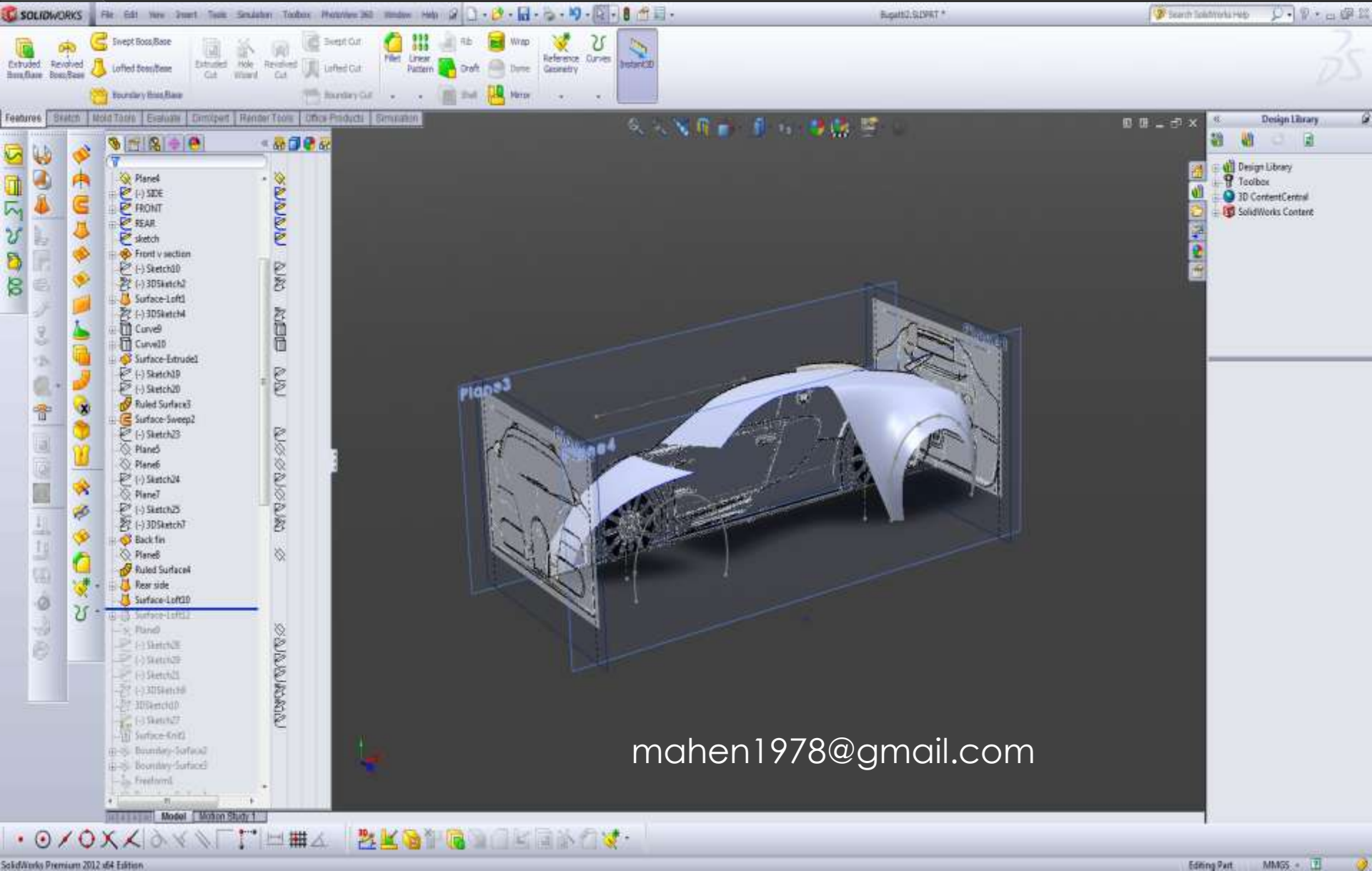

mahen1978@gmail.com

Surface Modeling portfolio with Illustration in Solidworks.

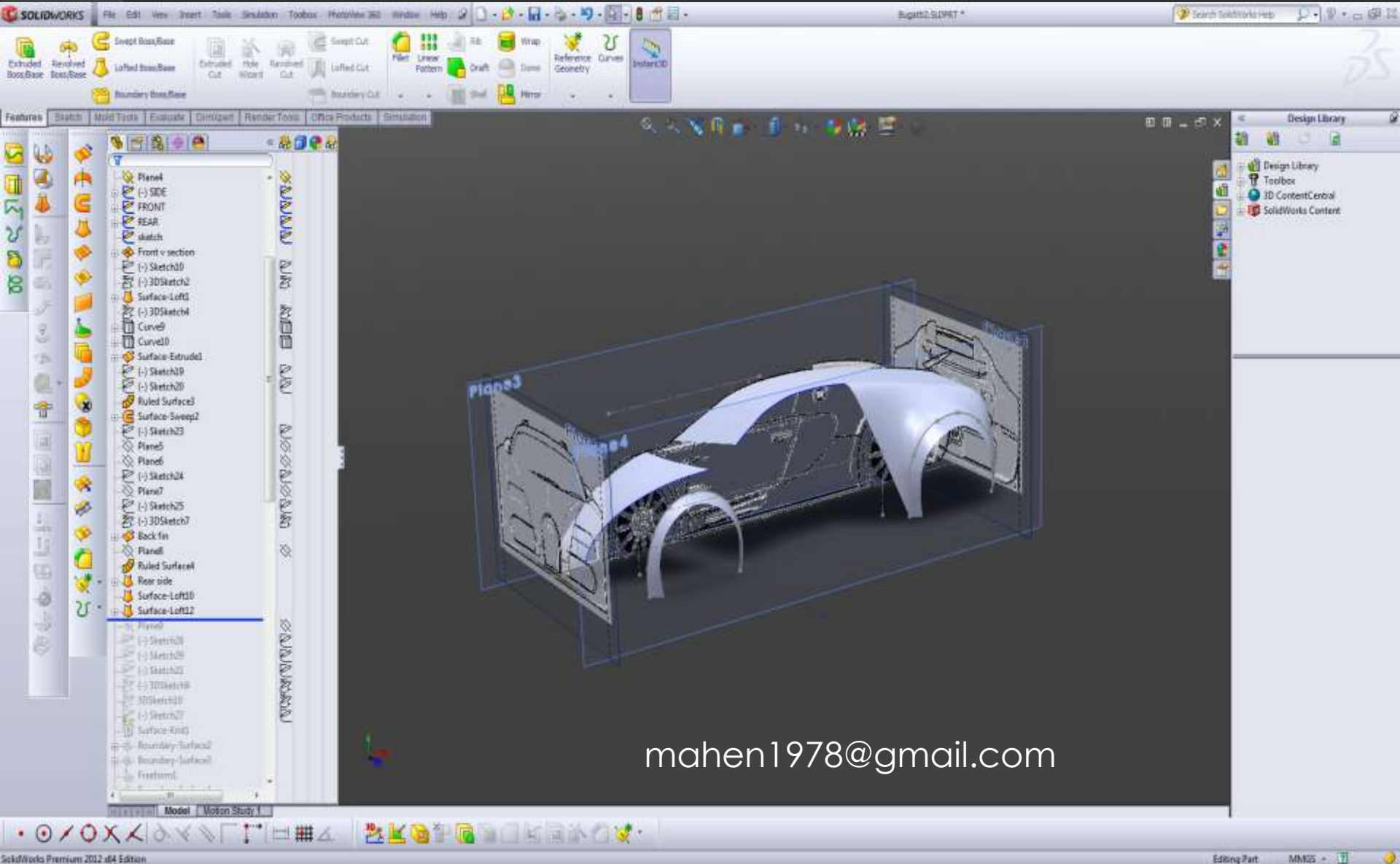

mahen1978@gmail.com

Surface Modeling portfolio with Illustration in Solidworks.

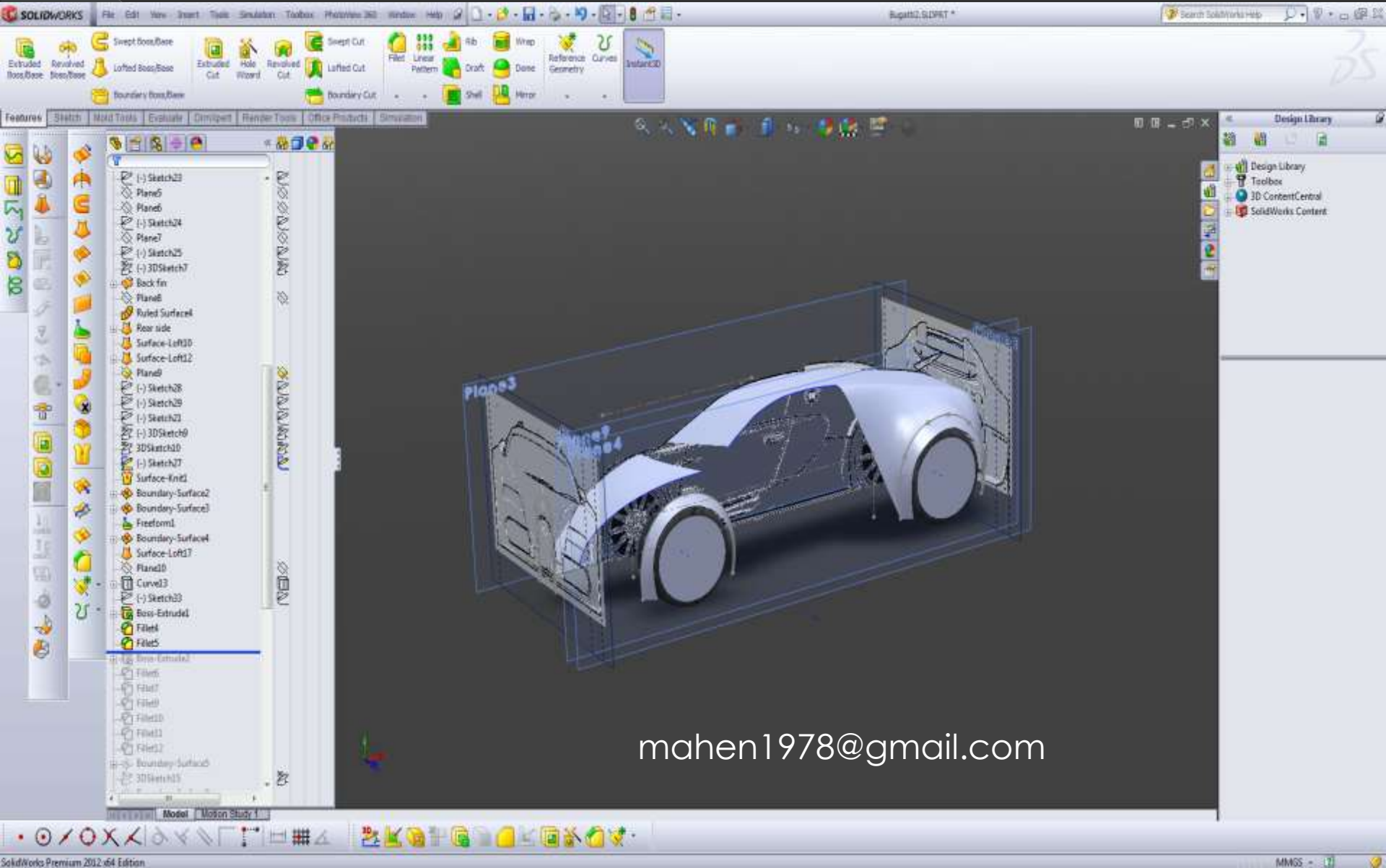

Surface Modeling portfolio with Illustration in Solidworks.

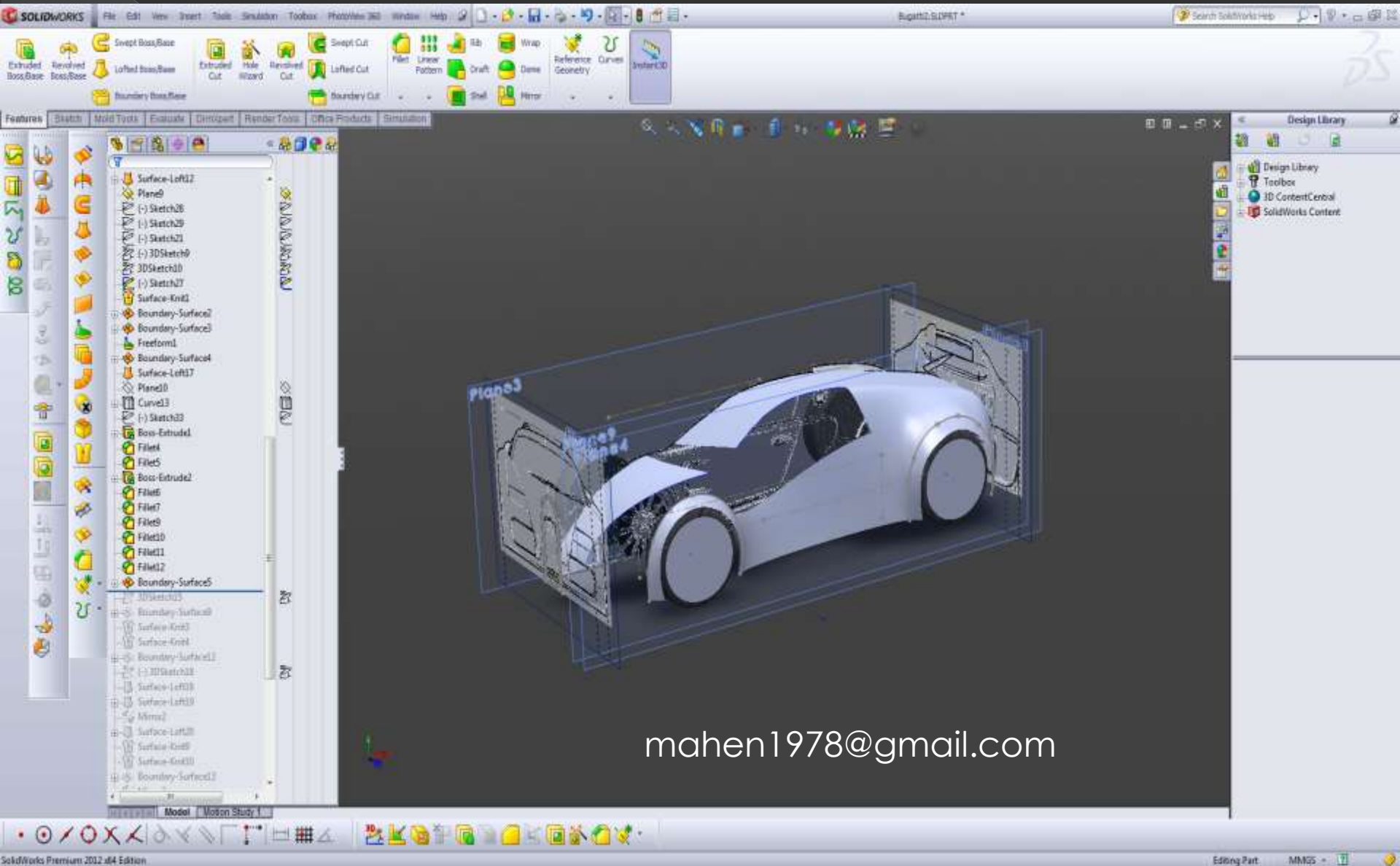

mahen1978@gmail.com

Surface Modeling portfolio with Illustration in Solidworks.

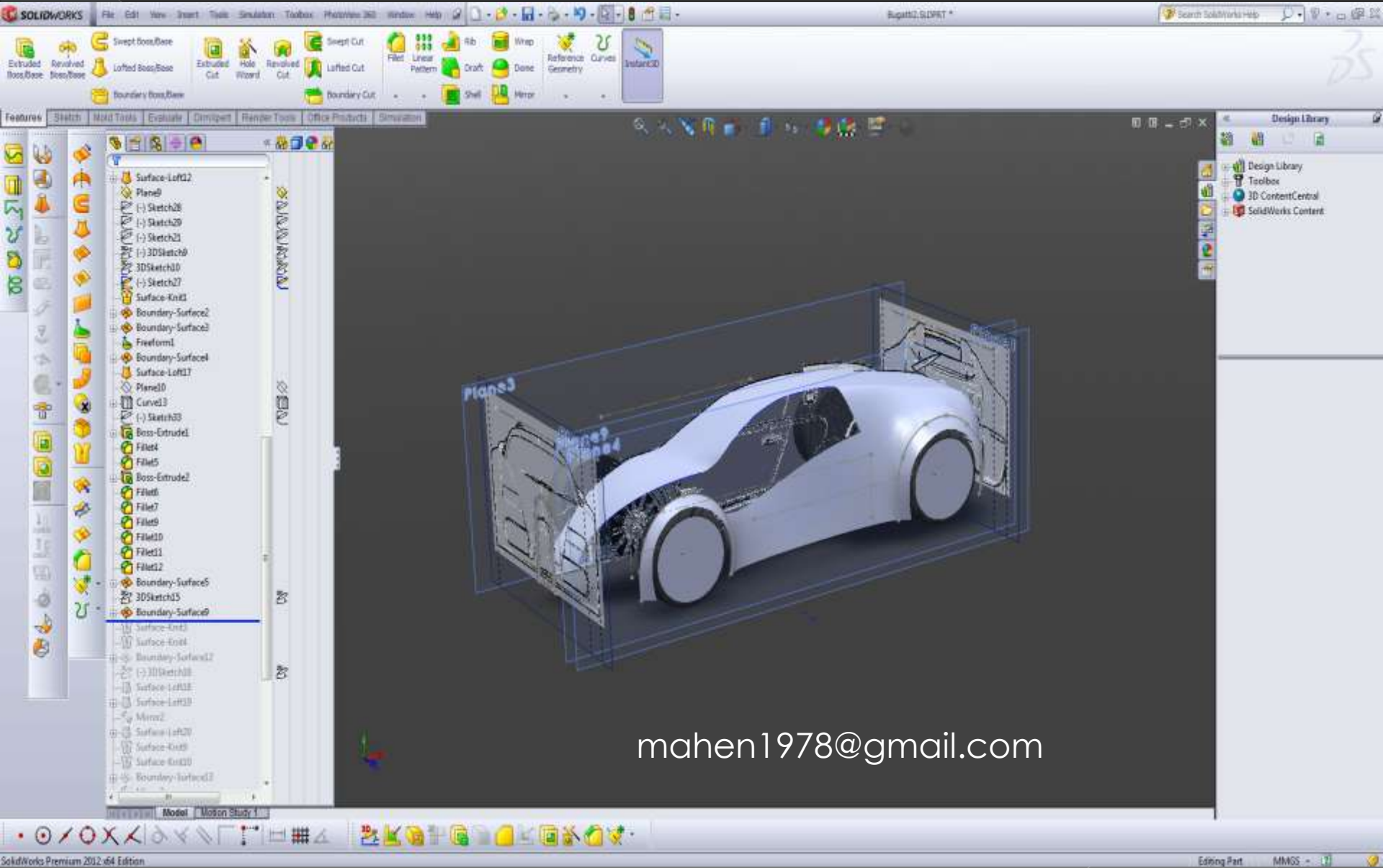

mahen1978@gmail.com

Surface Modeling portfolio with Illustration in Solidworks.

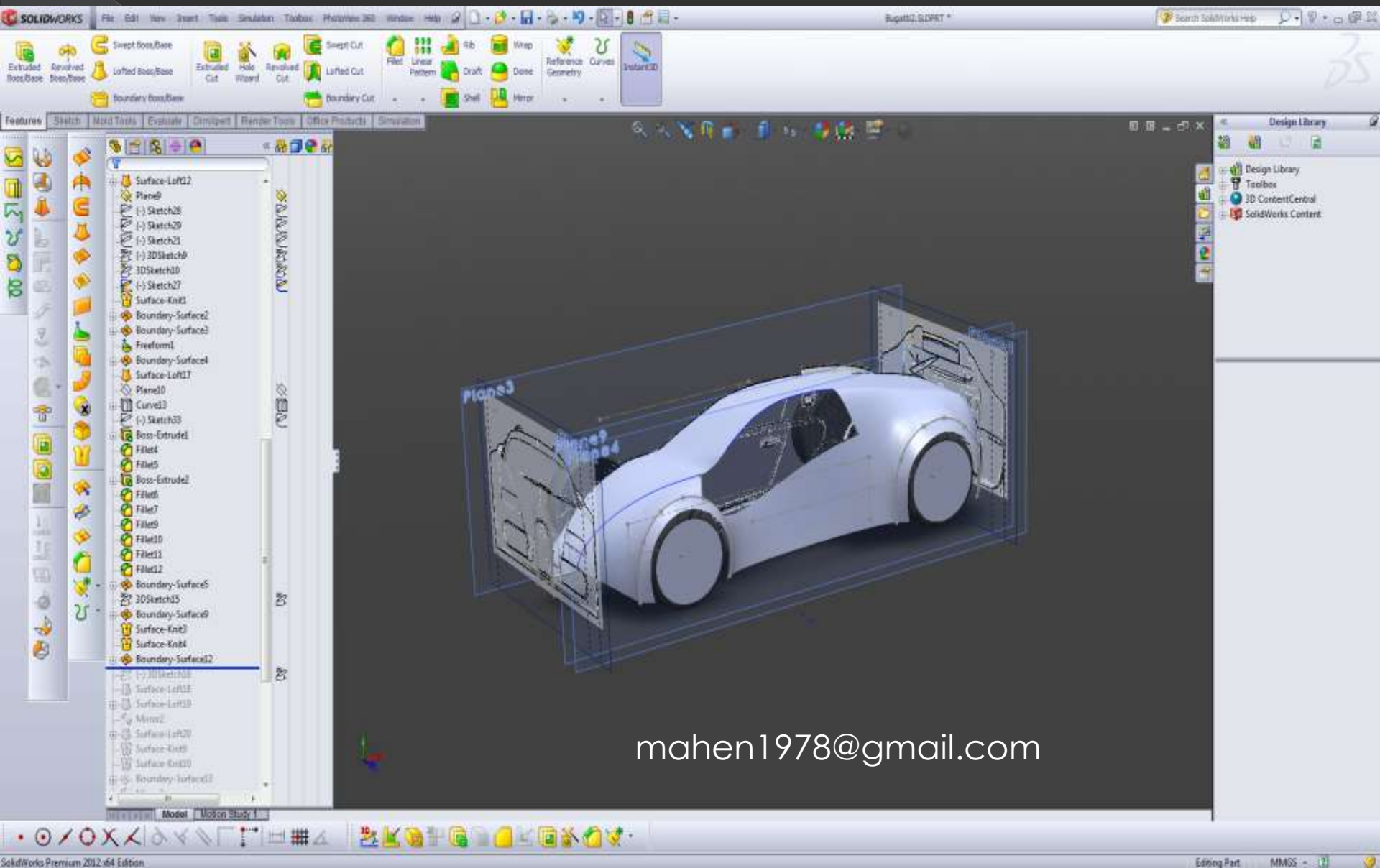

mahen1978@gmail.com

Surface Modeling portfolio with Illustration in Solidworks.

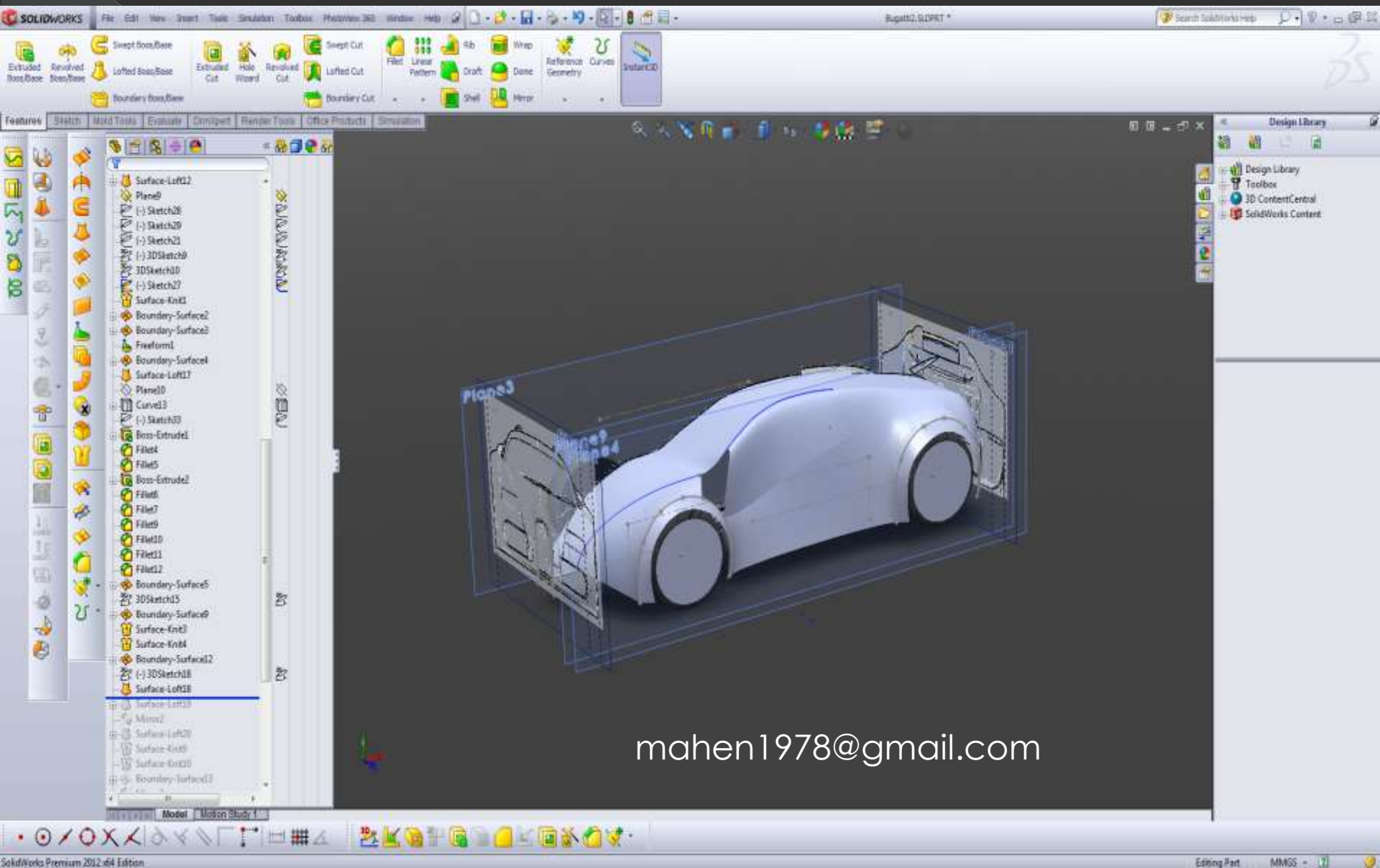

Surface Modeling portfolio with Illustration in Solidworks.

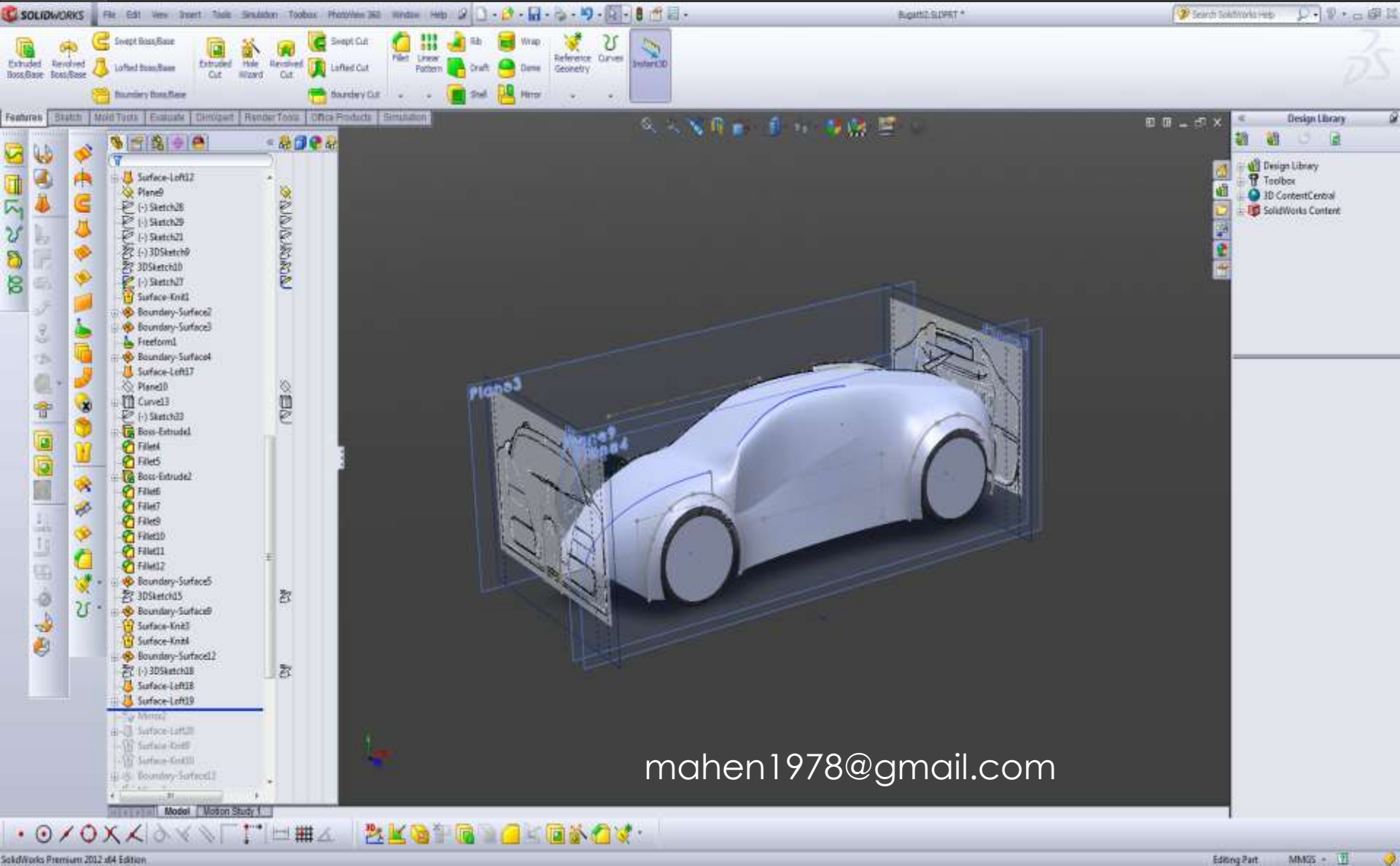

mahen1978@gmail.com

Surface Modeling portfolio with Illustration in Solidworks.

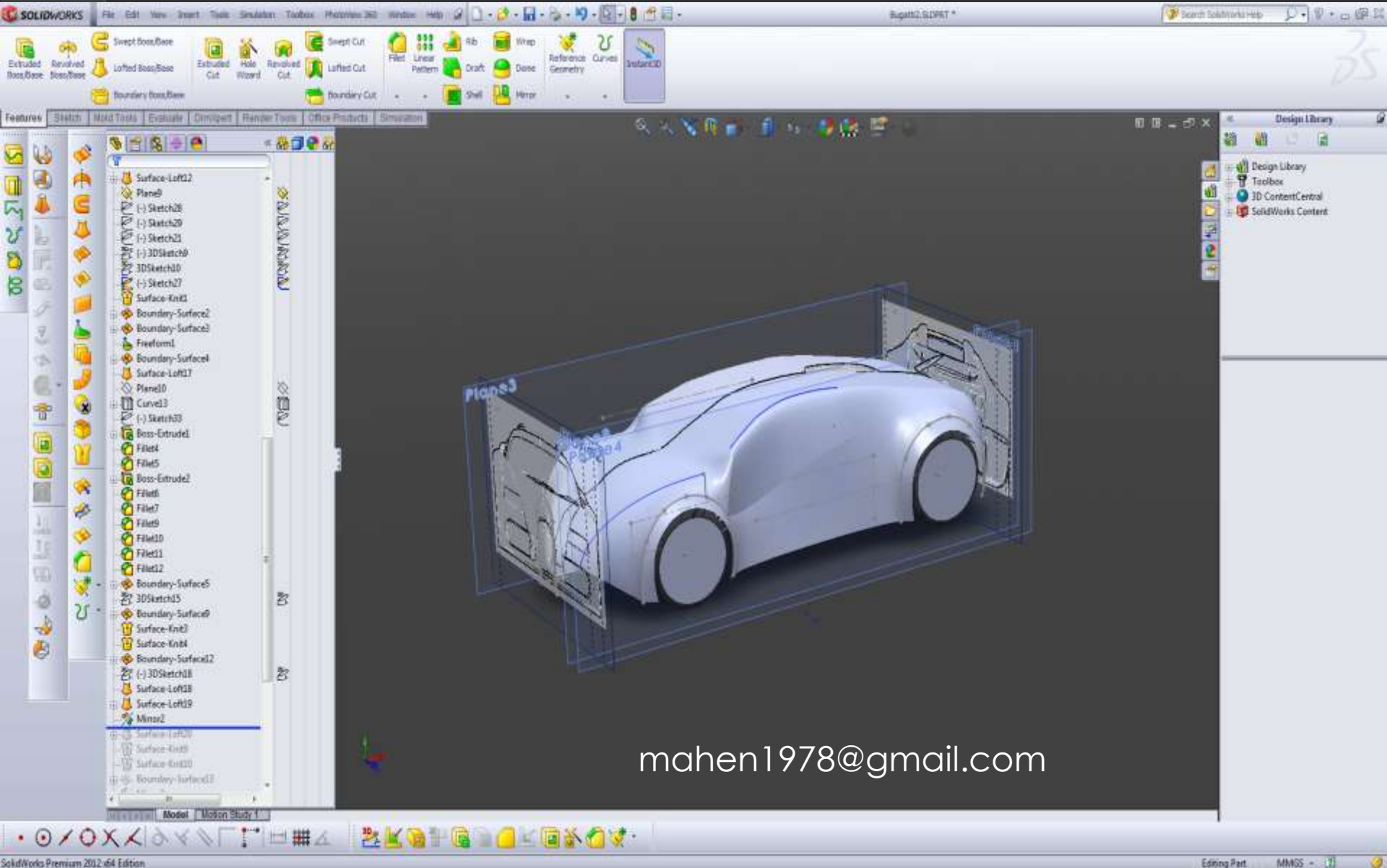

Surface Modeling portfolio with Illustration in Solidworks.

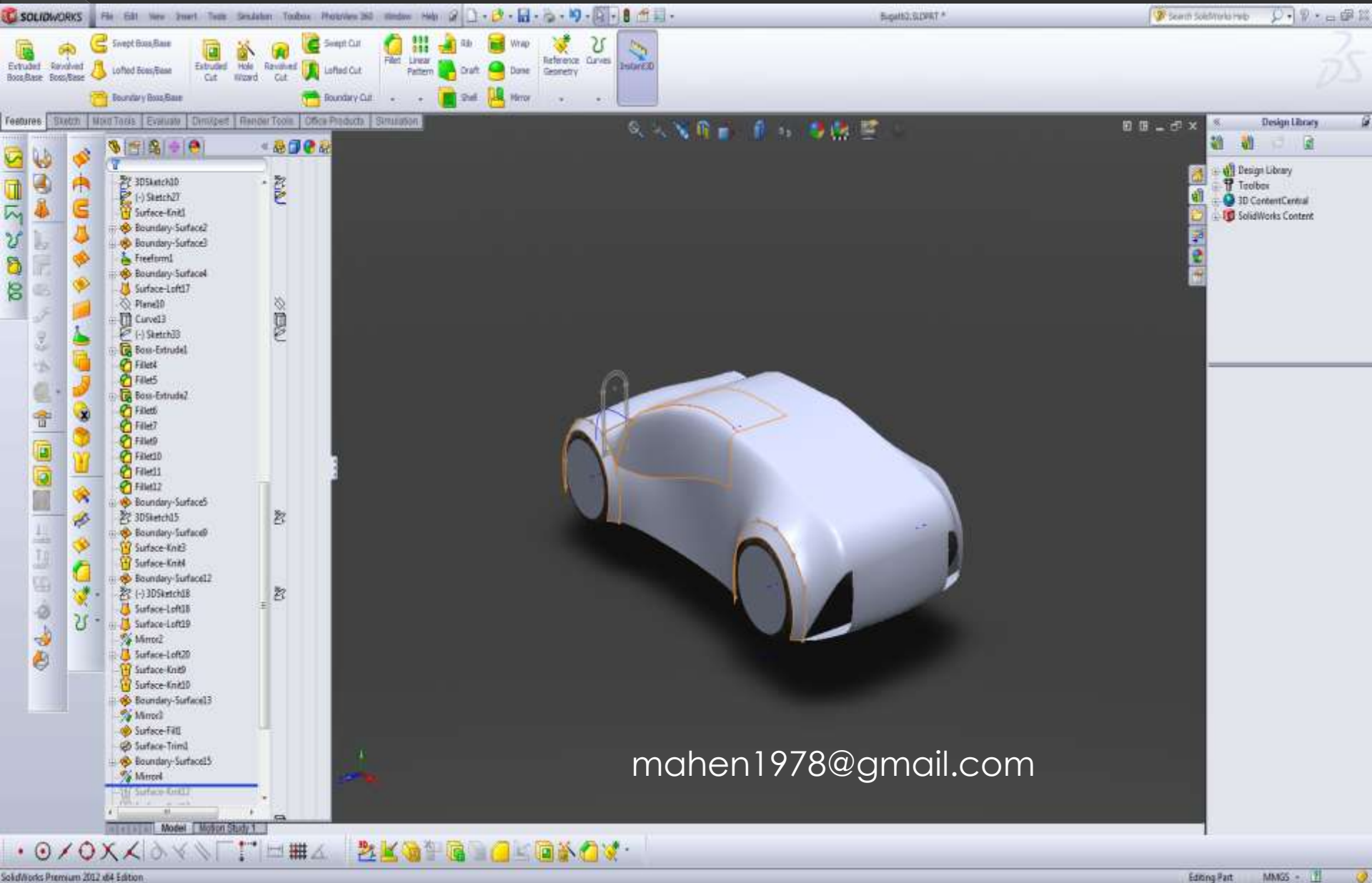

Surface Modeling portfolio with Illustration in Solidworks.

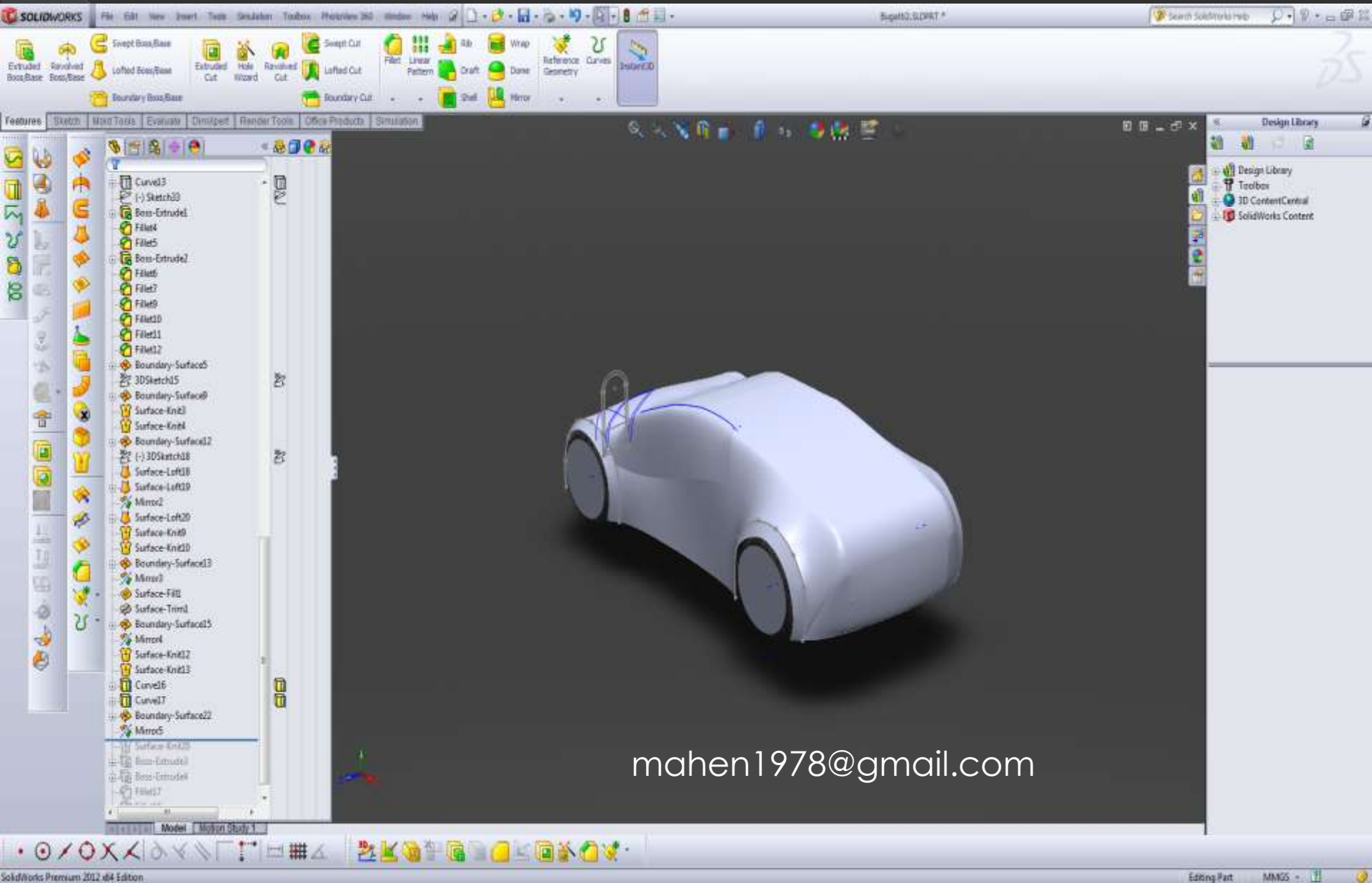

Surface Modeling portfolio with Illustration in Solidworks.

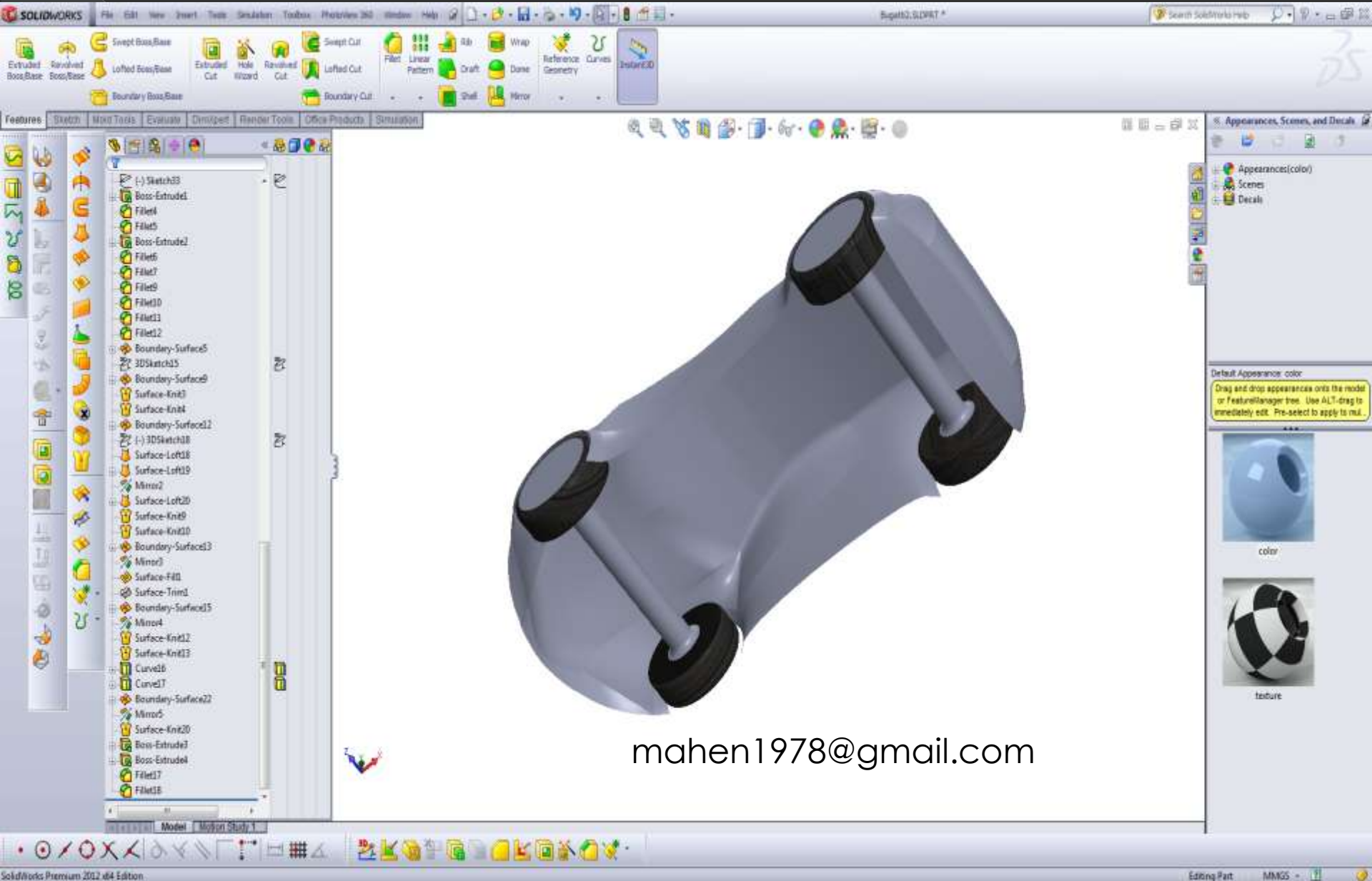

mahen1978@gmail.com

Surface Modeling portfolio with Illustration in Solidworks.

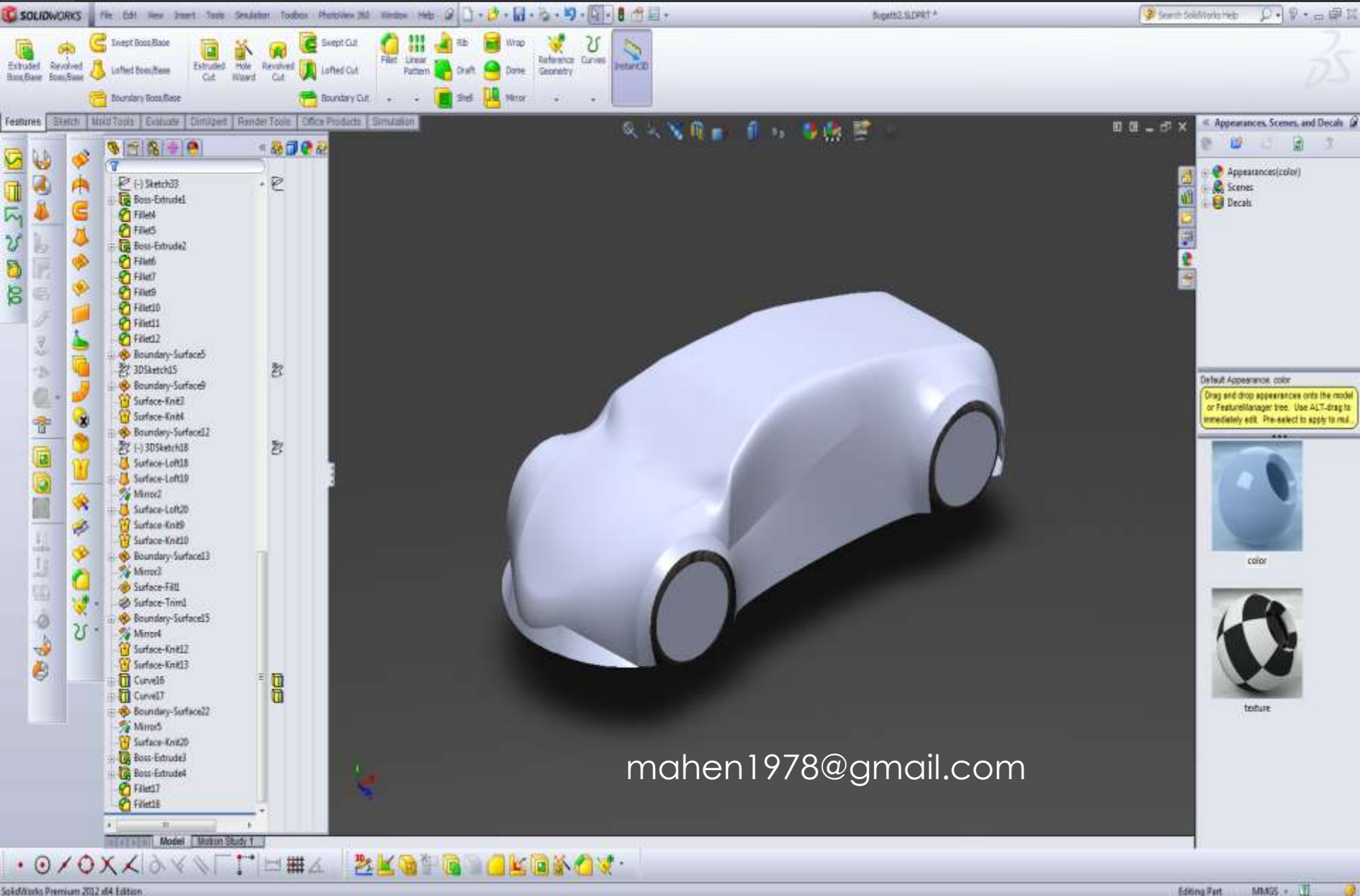

Surface Modeling portfolio with Illustration in Solidworks.

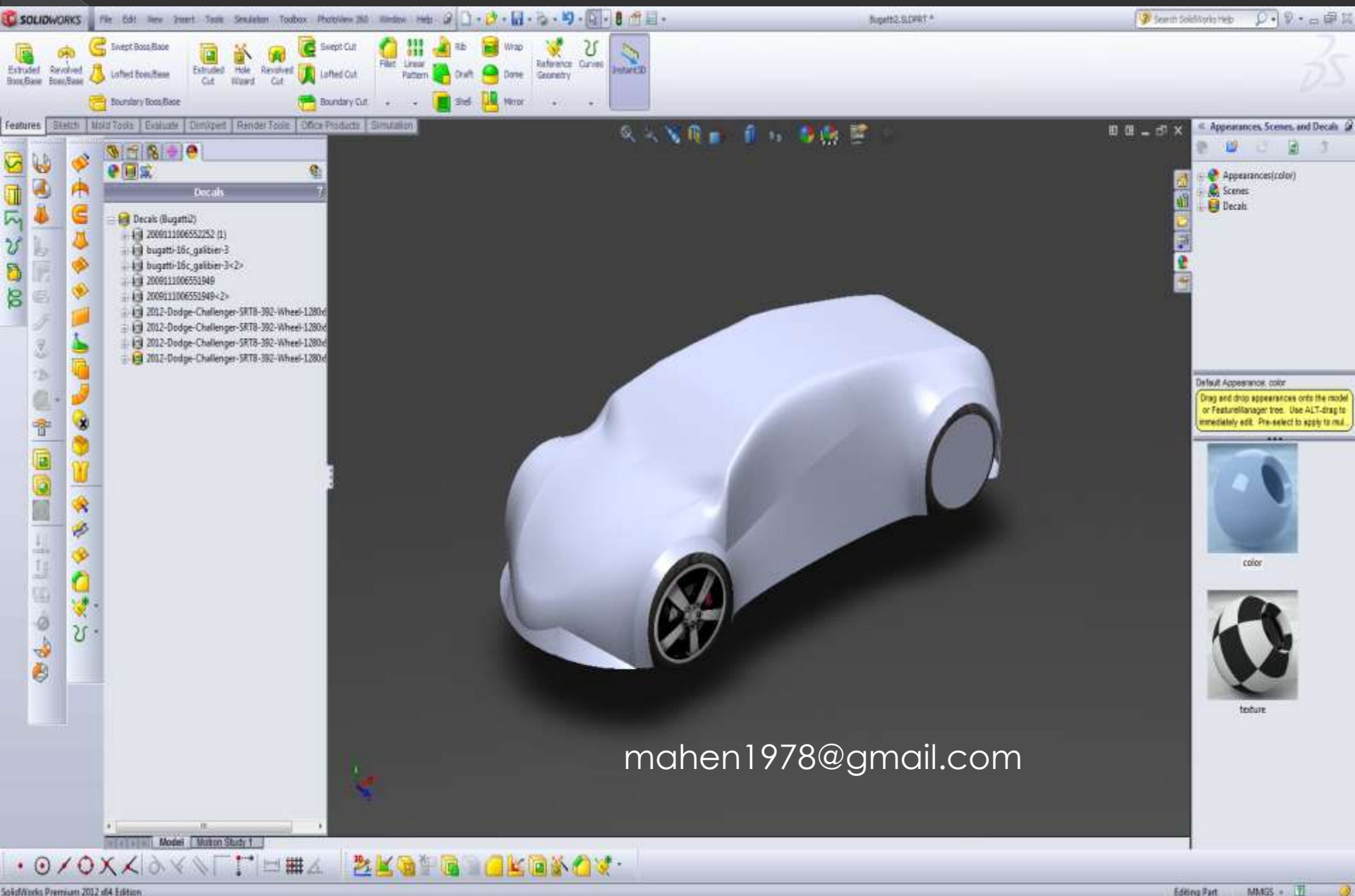

mahen1978@gmail.com

Surface Modeling portfolio with Illustration in Solidworks.

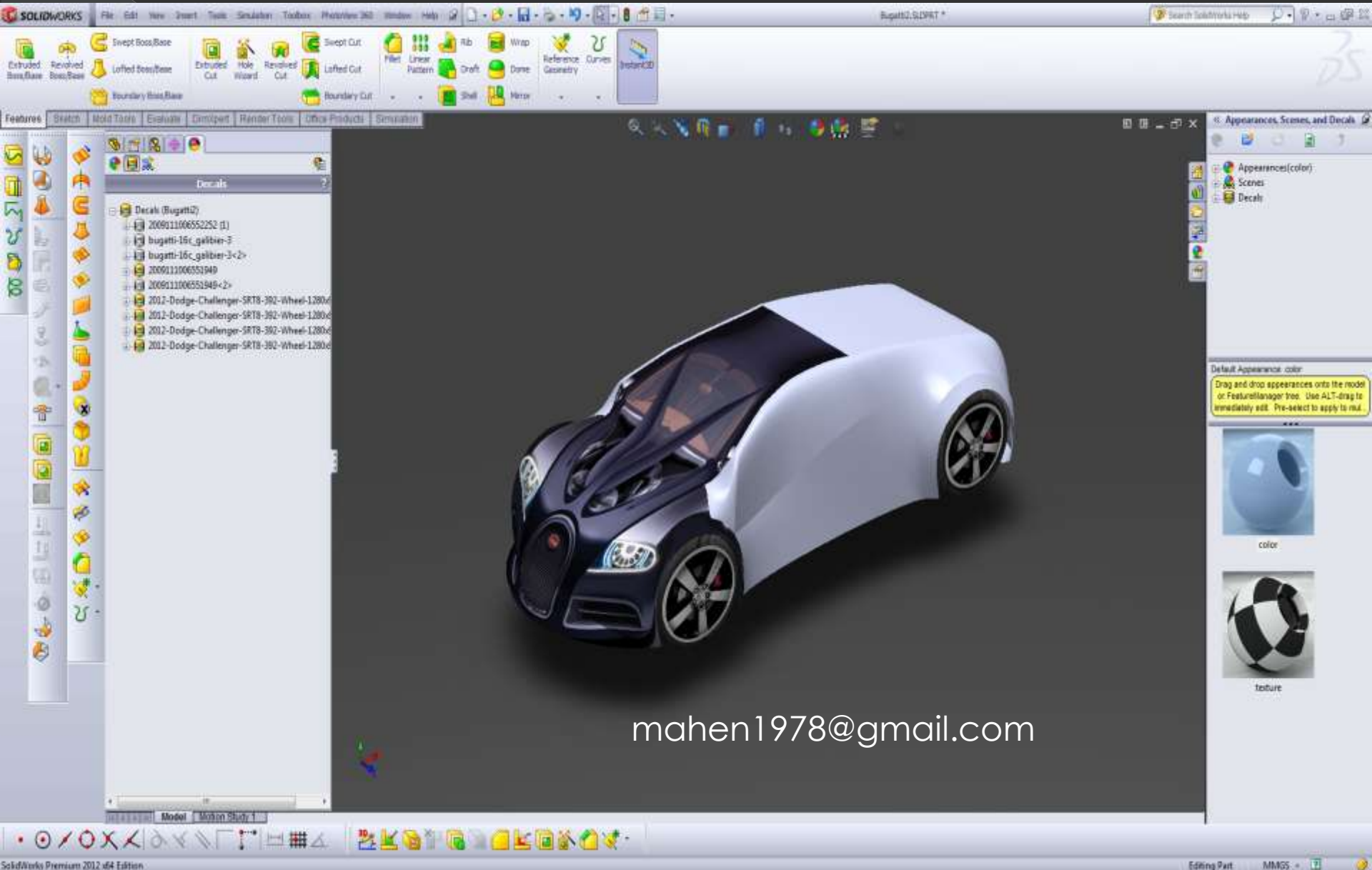

mahen1978@gmail.com

Surface Modeling portfolio with Illustration in Solidworks.

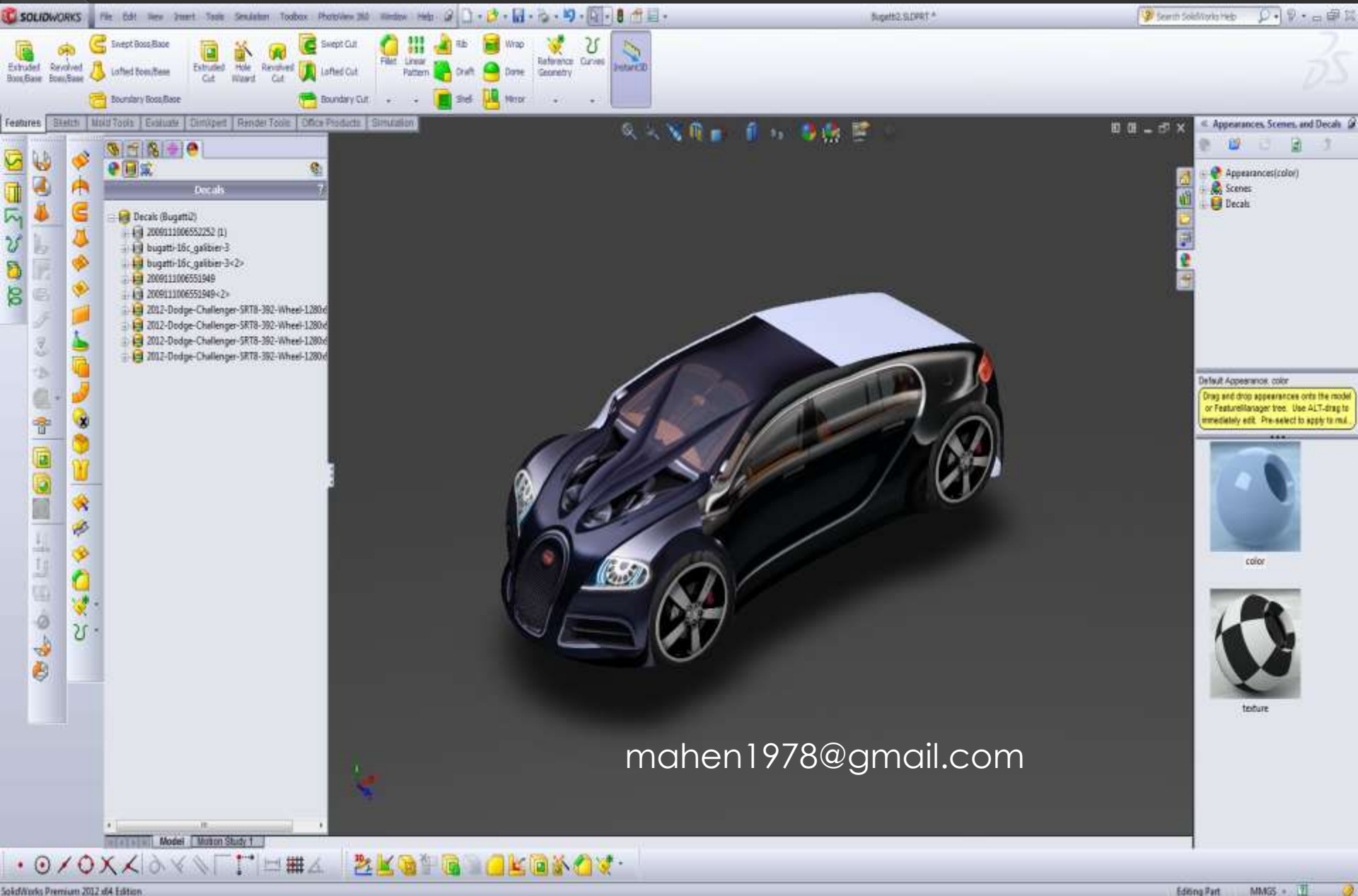

mahen1978@gmail.com

Surface Modeling portfolio with Illustration in Solidworks.

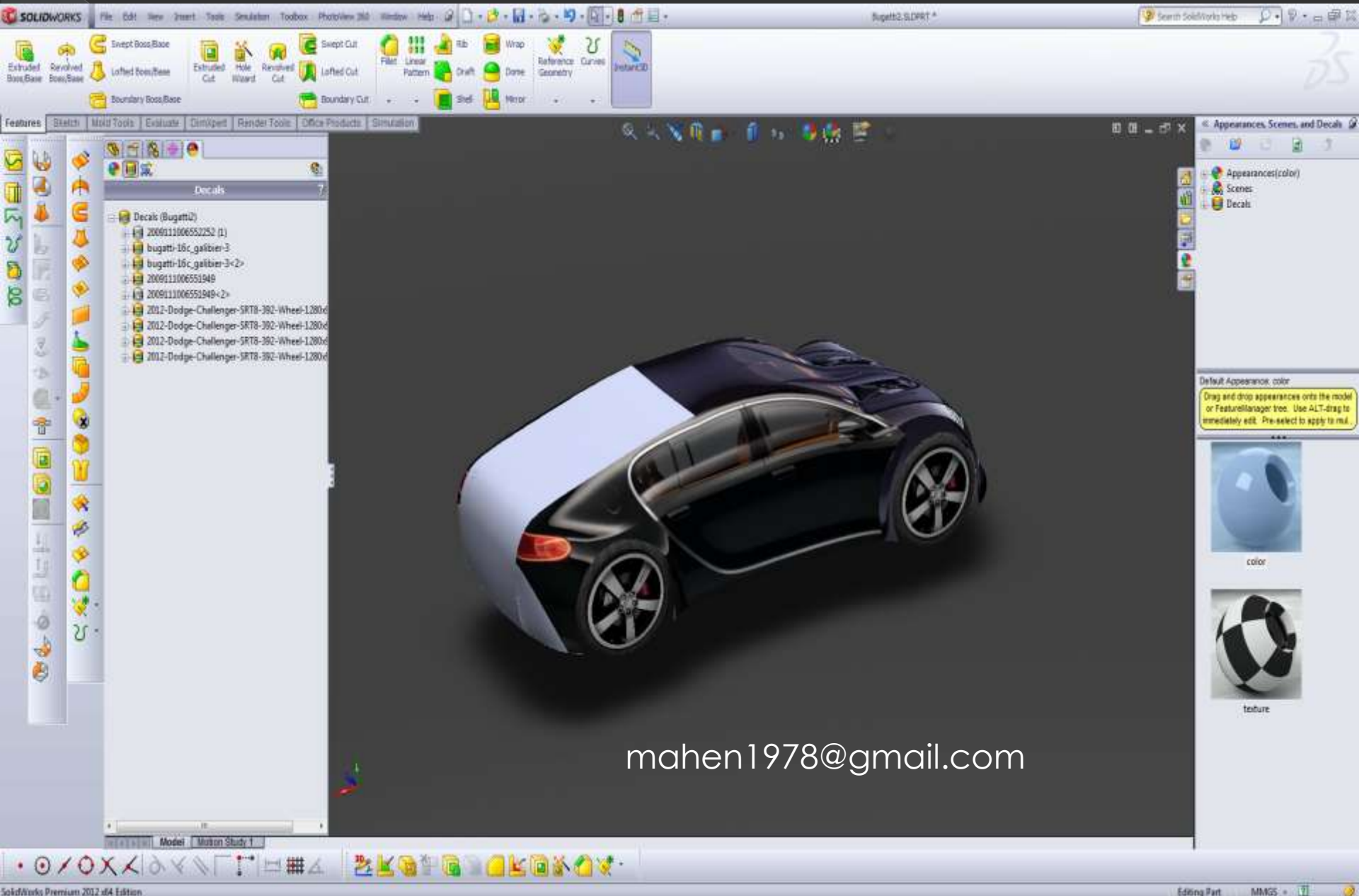

mahen1978@gmail.com

Surface Modeling portfolio with Illustration in Solidworks.

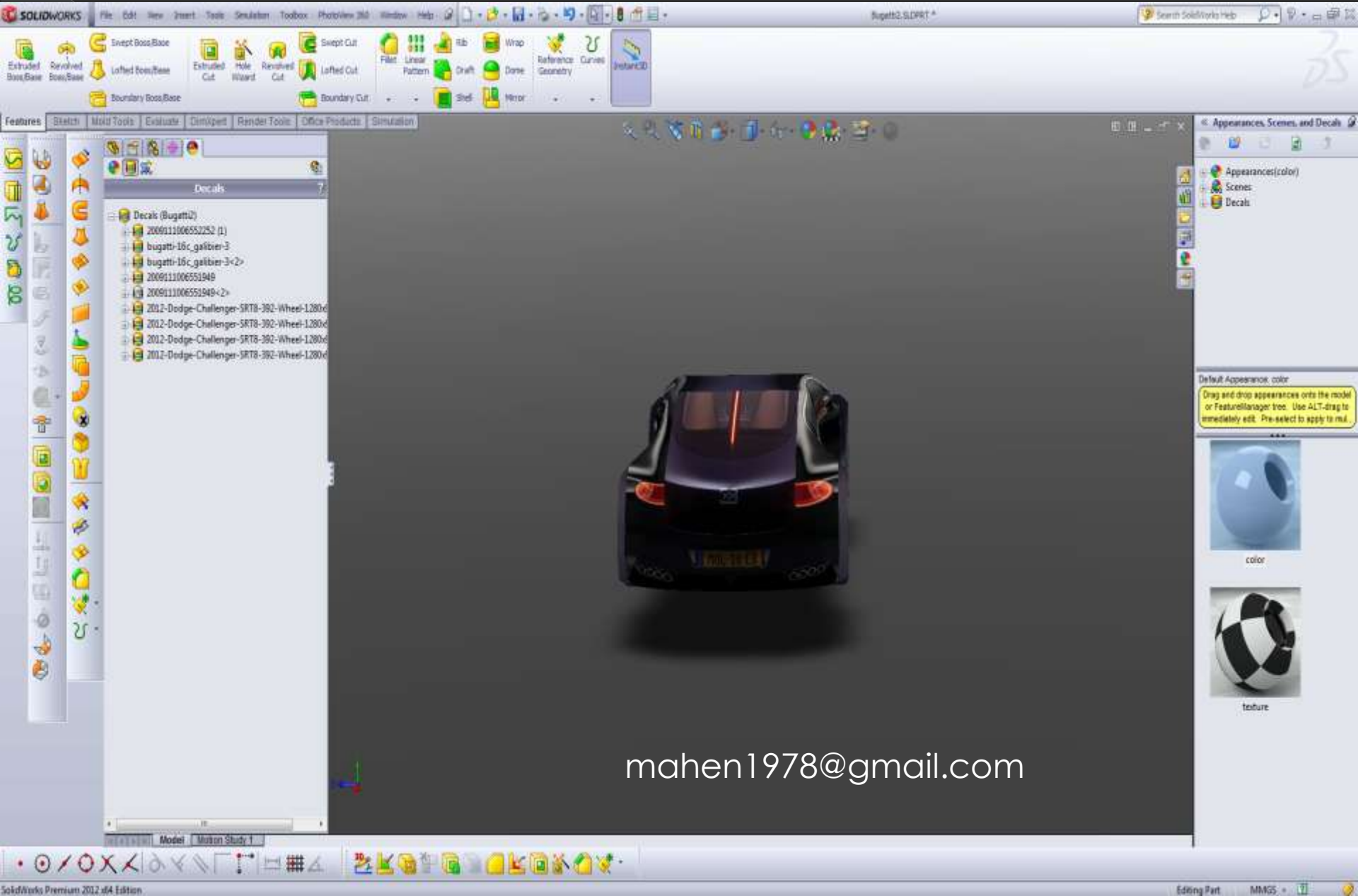

mahen1978@gmail.com

Surface Modeling portfolio with Illustration in Solidworks.

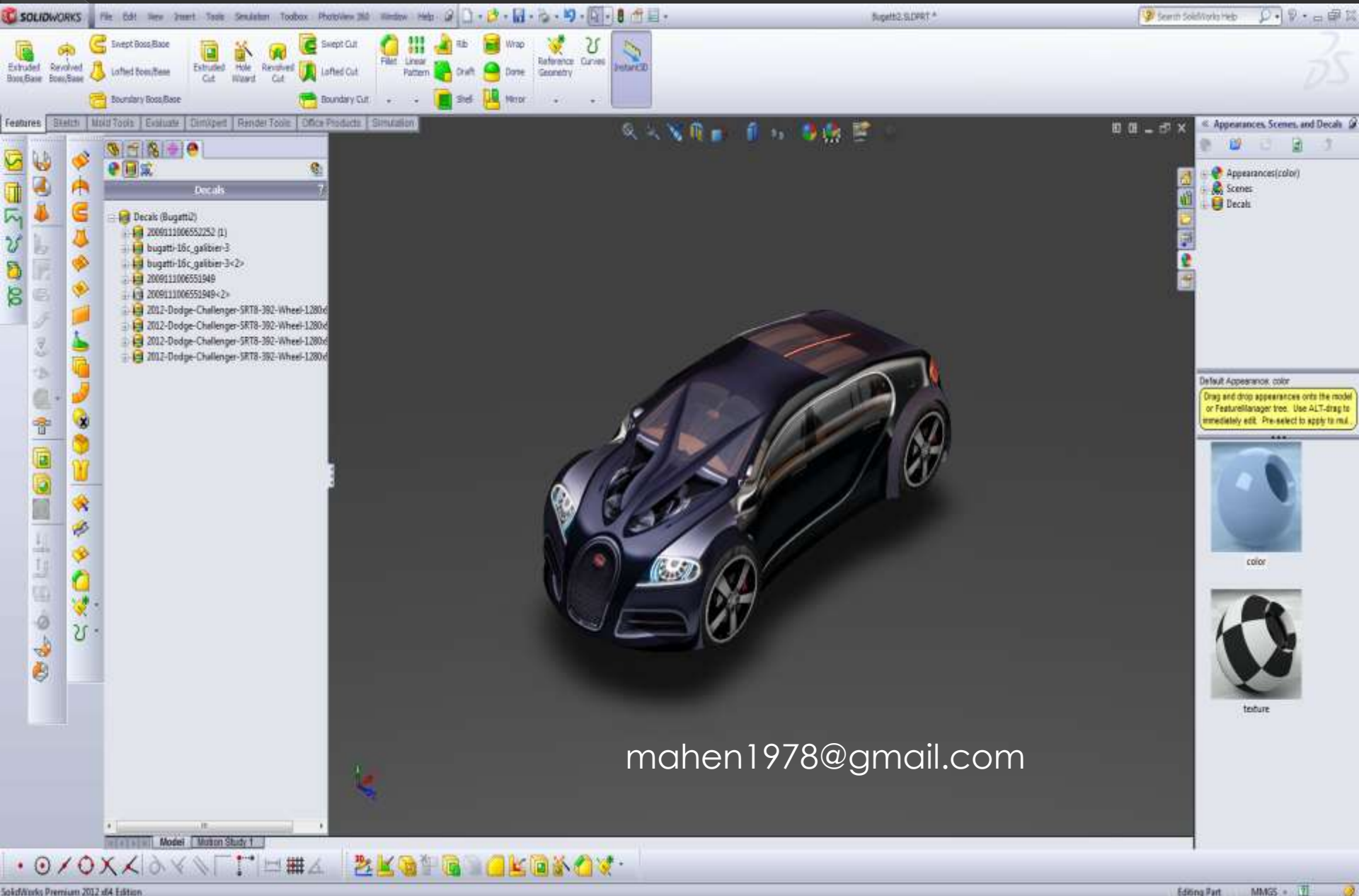



mahen1978@gmail.com



mahen1978@gmail.com