

Antonio Longobardo
DESIGNER



OTIS
EUROPE

LEAD DESIGNER 2004



2004
PRODUCT

OTIS (IEUROPE)



2004
PRODUCT

OTIS (IEUROPE)



2004
PRODUCT

OTIS (IEUROPE)

Corrimano "T.D."

1. Scorrimento laterale: Assolo e pannello
 2. Elemento di sostegno per fissare per il montaggio della scatola per la guida della mano (in 2 colori: alluminio anodizzato opaco, acciaio inox)
 3. Tubo assiale con spina elicoidale e connettore per il cavo di comando (in 2 colori: acciaio inox, alluminio anodizzato opaco)

Otis
 www.otis.com

Scorrimano "T.B"

1. Scatola in plastica con guida interna
 2. Cuneo di riduzione ad incastro sulla scatola della scatola
 3. Asse metallica integrata allo scorrimano
 4. Sostegno e supporto della struttura
 5. Poggiamani con anima in tubolare metallico ed esterno intercambiabile (acciaio, alluminio, plastica)

Otis
 www.otis.com

Display "T.A"

Il display è formato da una struttura in plastica stampata in 3D, effetto metallo, lucido e satinato. In due quadranti inferiori è possibile vedere il numero della cabina. Il display è fornito in versione a carattere informativo.

Componenti presenti:
 1. Schermo LCD
 2. Quadro esterno
 3. Supporto
 4. Elemento di montaggio
 5. Cavo informativo

Non presente: Poggiamani
 Utensili
 www.otis.com

Otis
 www.otis.com

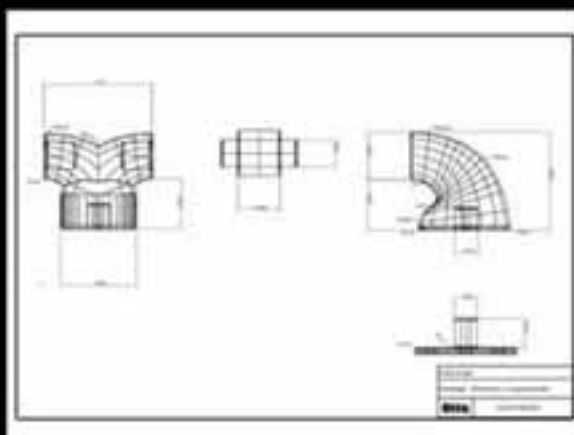

1

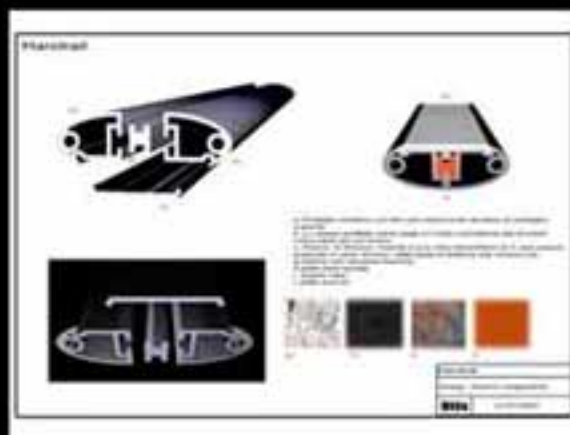

2



3

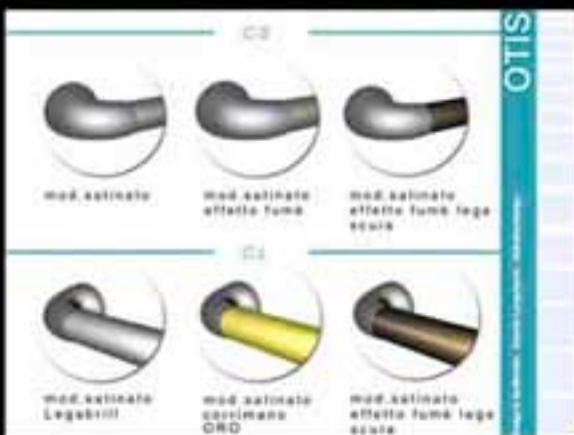

4



5



6



PIQUADRO

ITALY

DESIGNER 2001



2004
PRODUCT

PIQUADRO (ITALY)



FERRARI

ITALY

DESIGNER 2006 FOR MIKITODESIGN

3D SKETCH DESIGN

Fronte - Retro.

Logo

FERRARI (front).

Cavallino (back).

Logo

FERRARI (front).

Testo a rilievo filettato
molato - superficialmente
1 mm spessore lastra
0.5mm spessore testo.

Gli elementi in rosso
indicano la zona di
contatto con le
parti magnetiche/metalliche.

Le fresature sul fronte
della clip sono passanti
posteriormente.

La clip verra' prodotta in acciaio
per ottenere una massima
flessibilita' nei movimenti
d'utilizzo con una doppia
componente ferrosa - magnetica
sul retro, per mantenere il supporto
con gli altri elementi esterni
di fissaggio

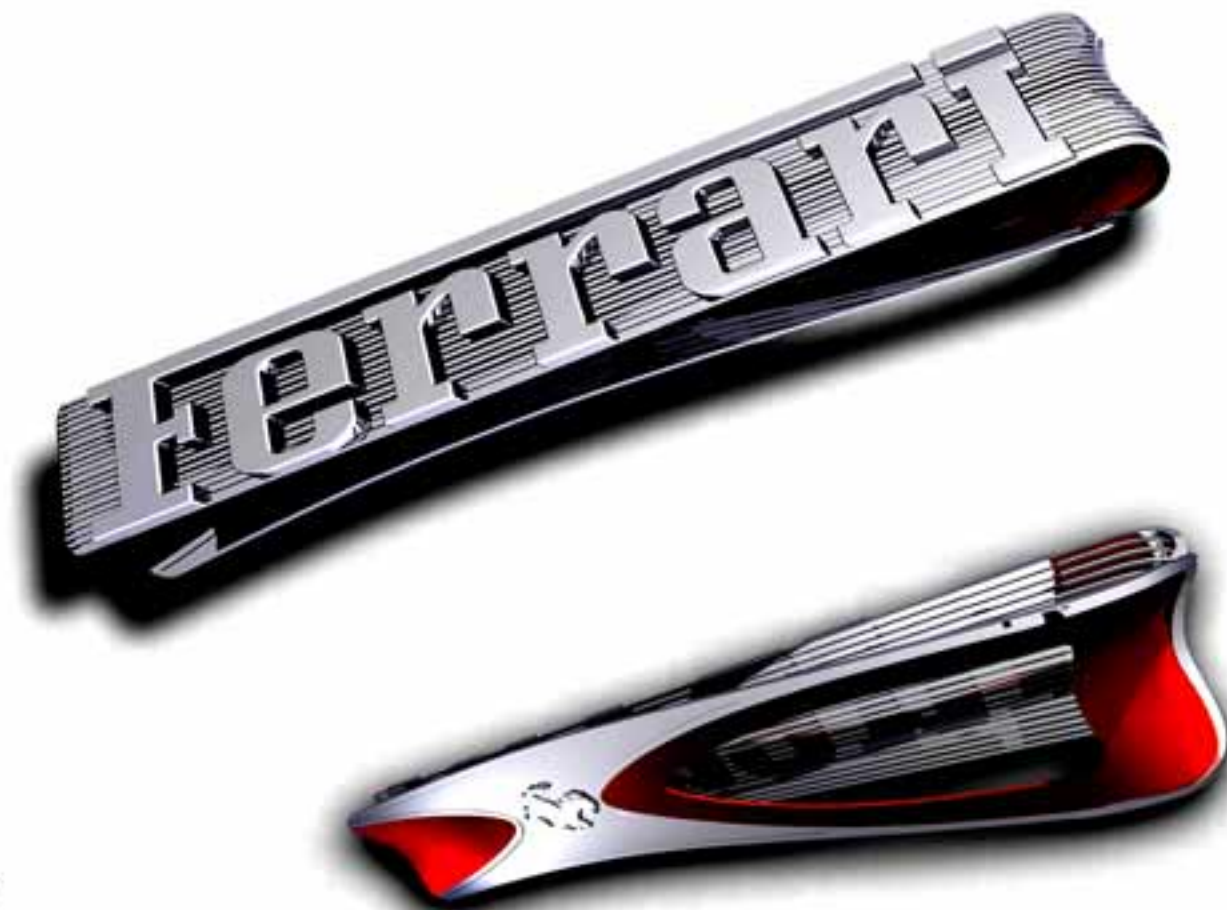

XIKITO

Progetto

Ferrari

Clip Intelligente

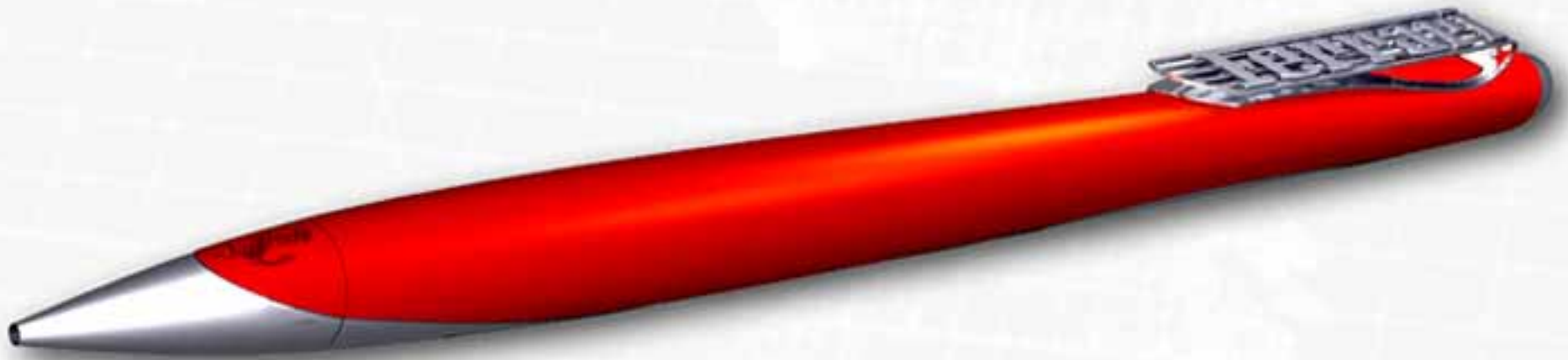

ALIKITO

Penna Sfera

Ferrari

2007
PRODUCT

FERRARI (ITALY)

3D SKETCH DESIGN

Applicazione Clip
Ferma soldi

Categoria.
Accessori.



AIKITA

Uso ed Utilizzo

Ferrari

Clip Intelligente

2007
PRODUCT

FERRARI (ITALY)



2007
PRODUCT

FERRARI (ITALY)



PLUS LIGHT TECH

INDIA

LEAD DESIGNER 2008

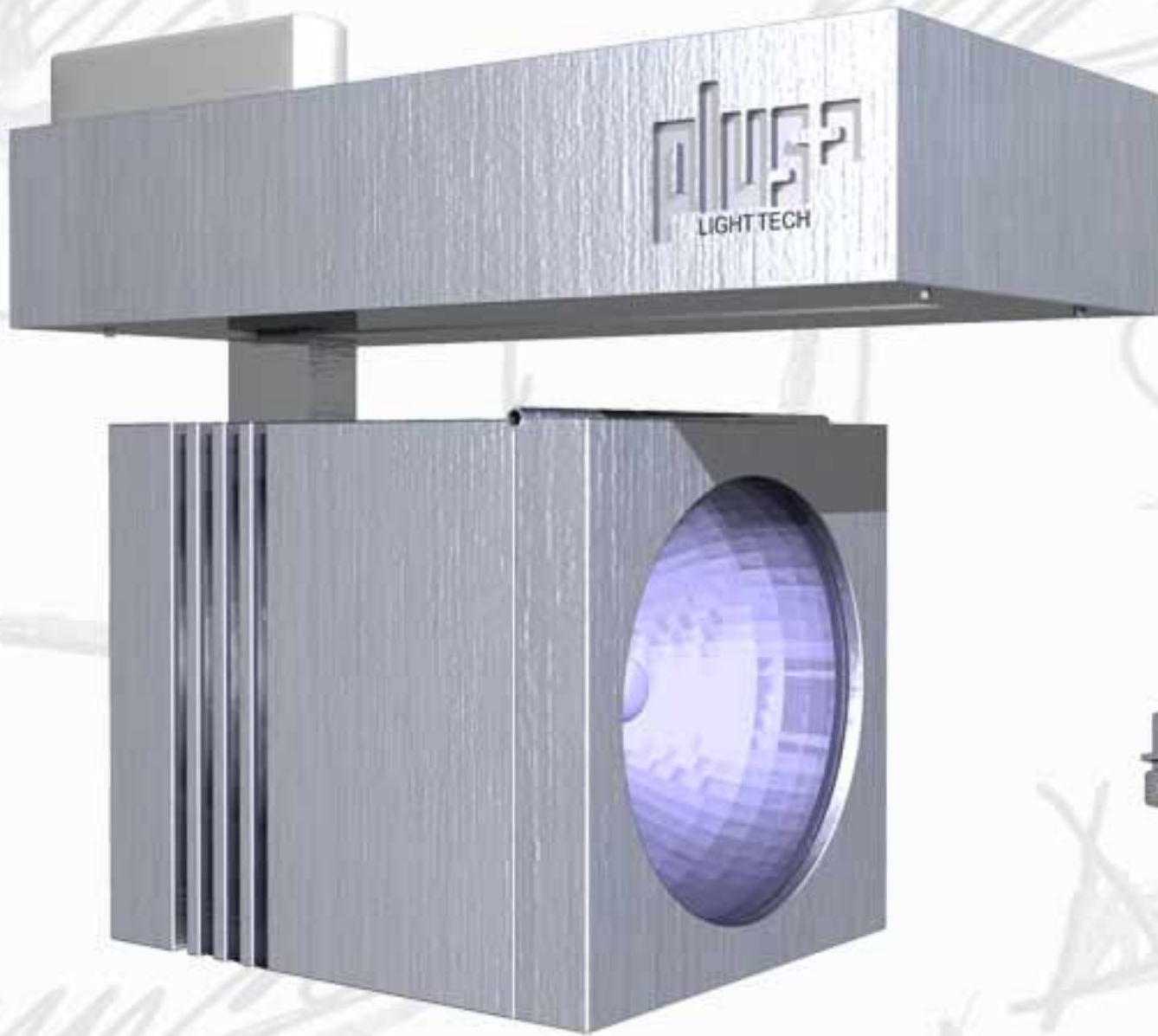

2007
PRODUCT

PLUS LIGHT TECH (INDIA)

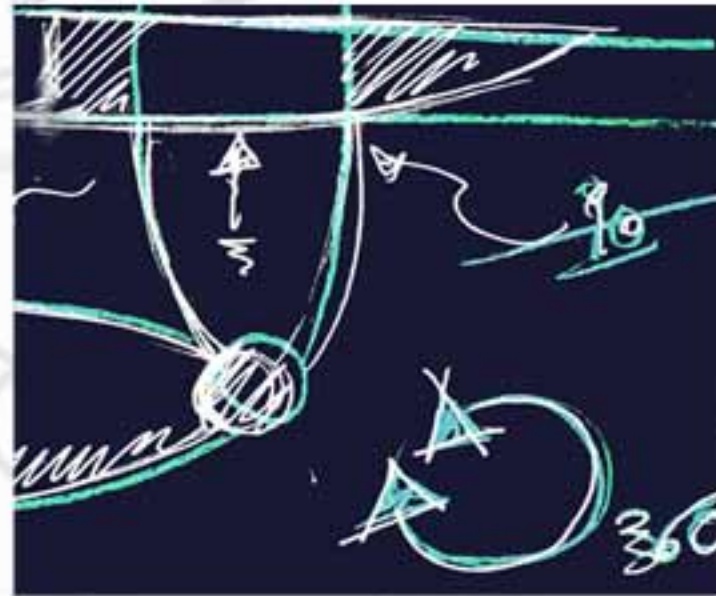
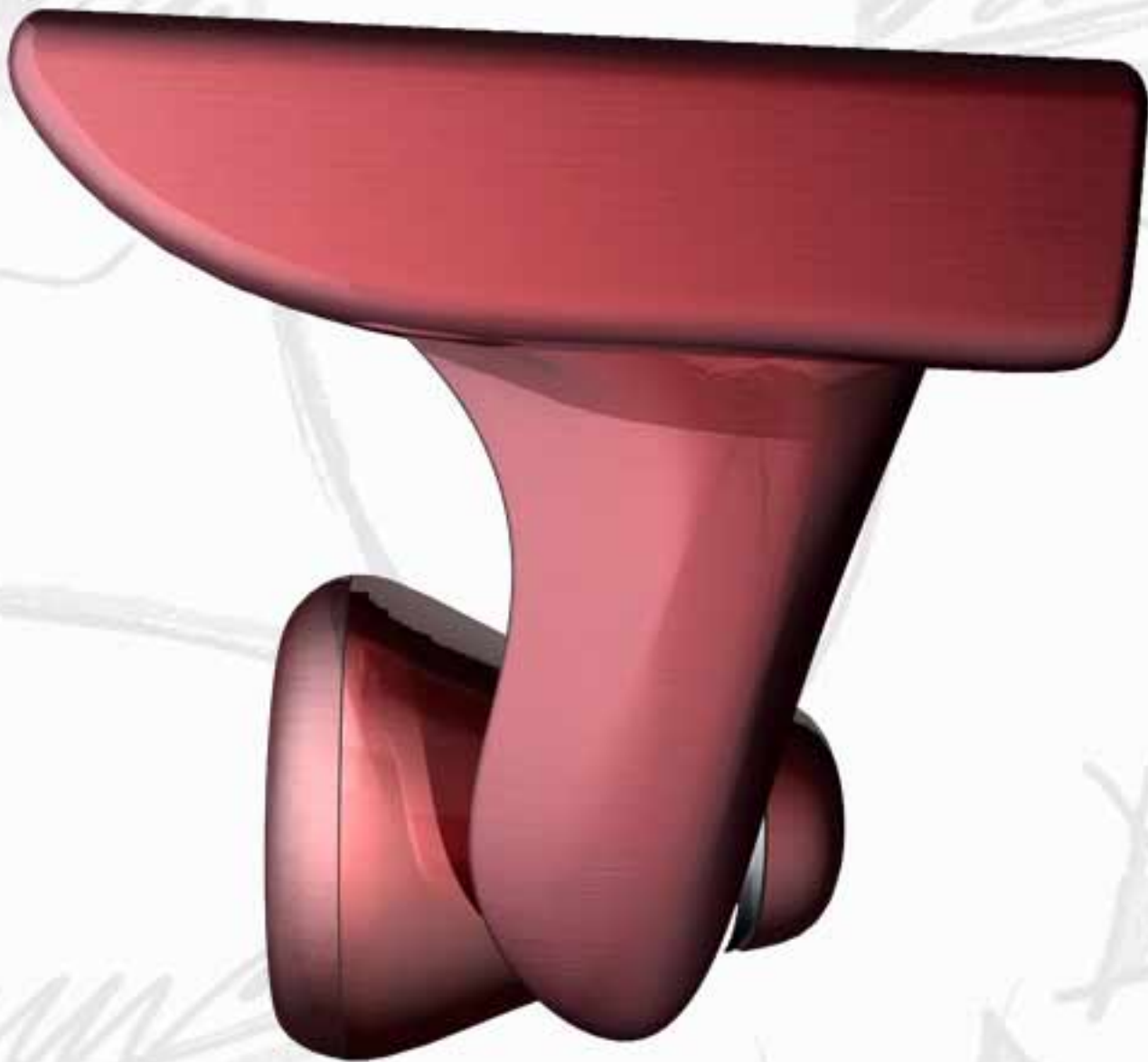

2007
PRODUCT

PLUS LIGHT TECH (INDIA)



2007
PRODUCT

PLUS LIGHT TECH (INDIA)



LA DOLCE VITA
ITALY

LEAD DESIGNER 2001



2005
PRODUCT

LA DOLCE VITA (ITALY)



LPA Ltd
UK

DESIGNER 2005 2006



2005/6
PRODUCT

LPA LTD (IUK)



DFC
INDIA

LEAD DESIGNER 2008

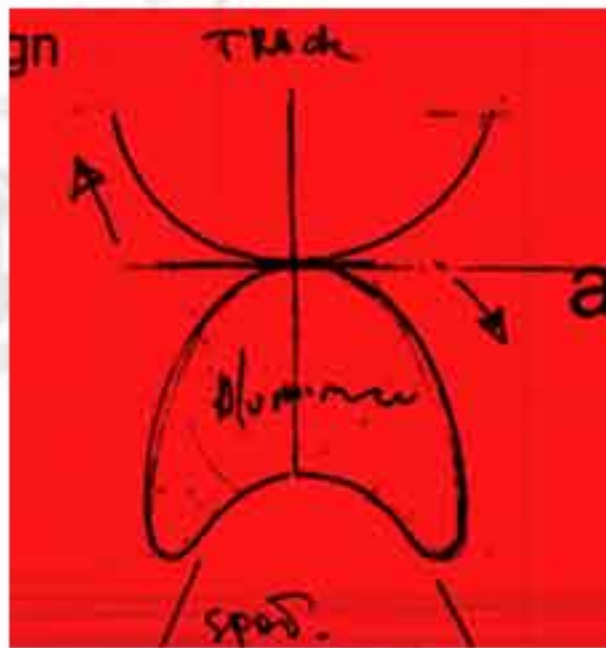
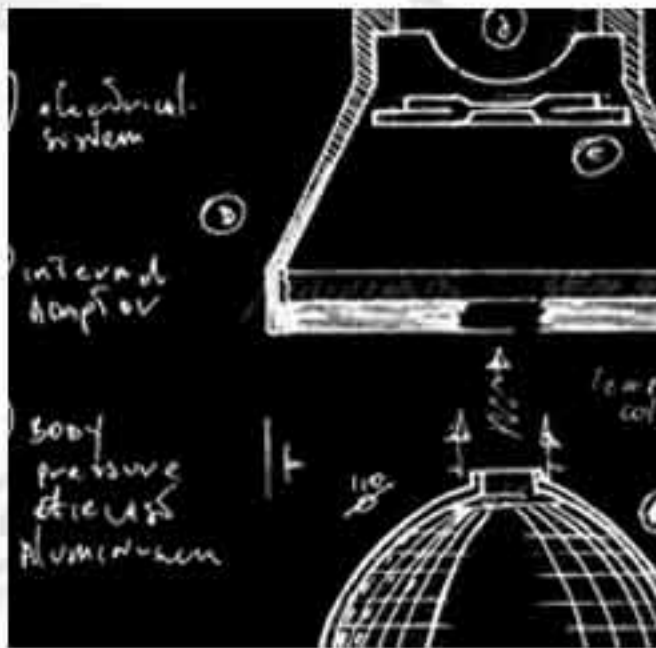
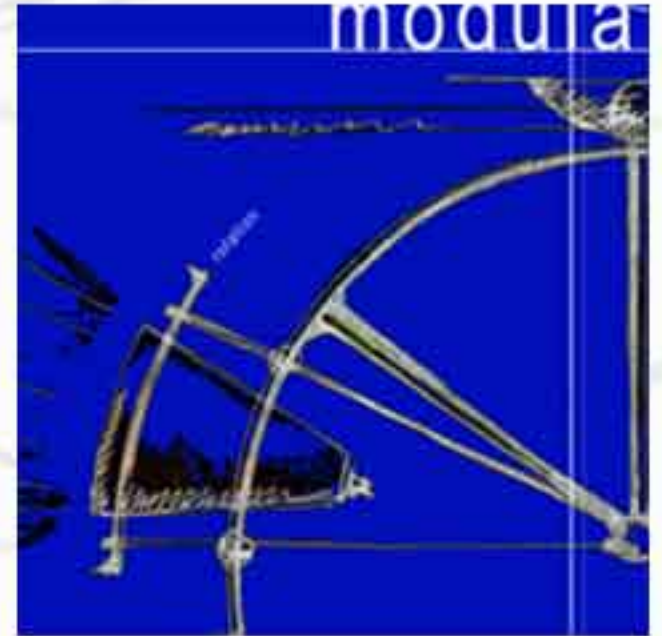
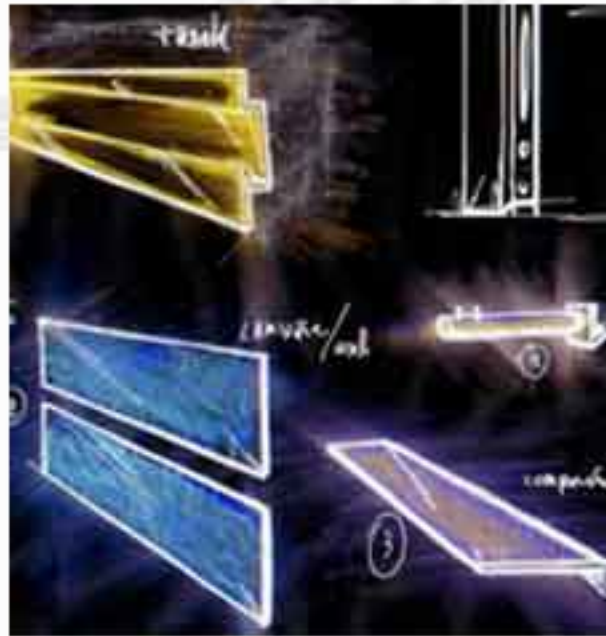
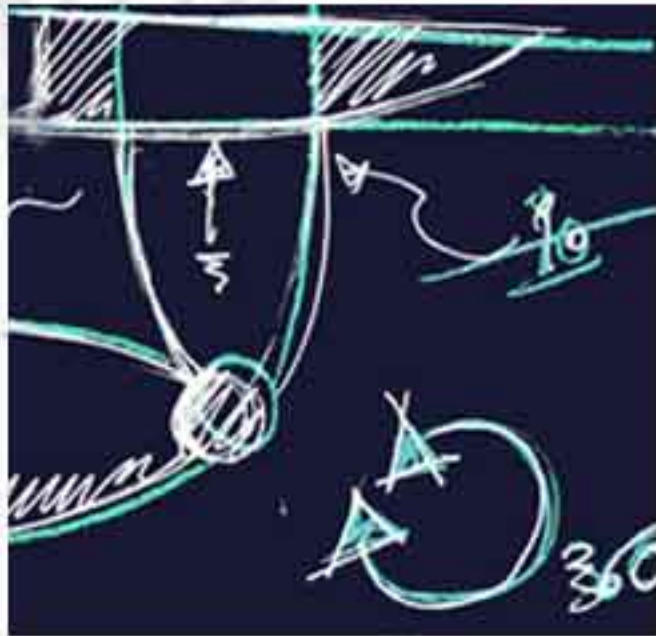



PROSPER

THAILAND

DESIGNER 2008

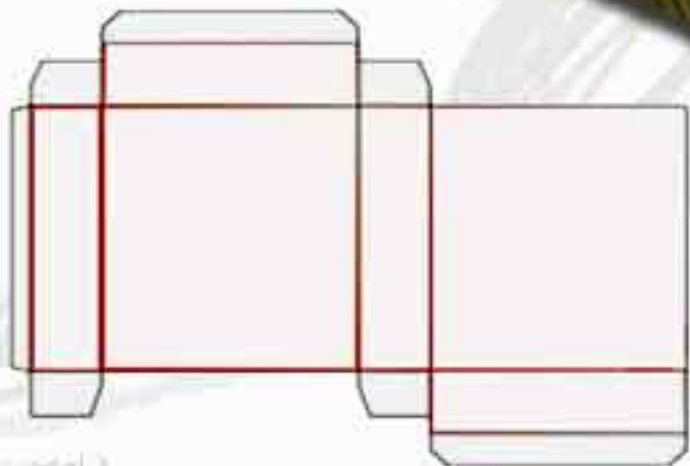

Model 3

2008
PRODUCT

PRS (THAILAND)



HOME CONNEXION

EUROPE

LEAD DESIGNER 2007

ROMANTIC

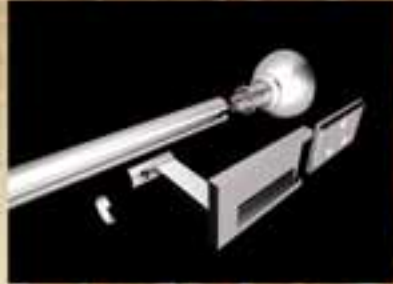

supporto A



supporto B



supporto a



supporto b



supporto c



supporto d

VARIANTI DI FINITURA

G&S
N
CENTE

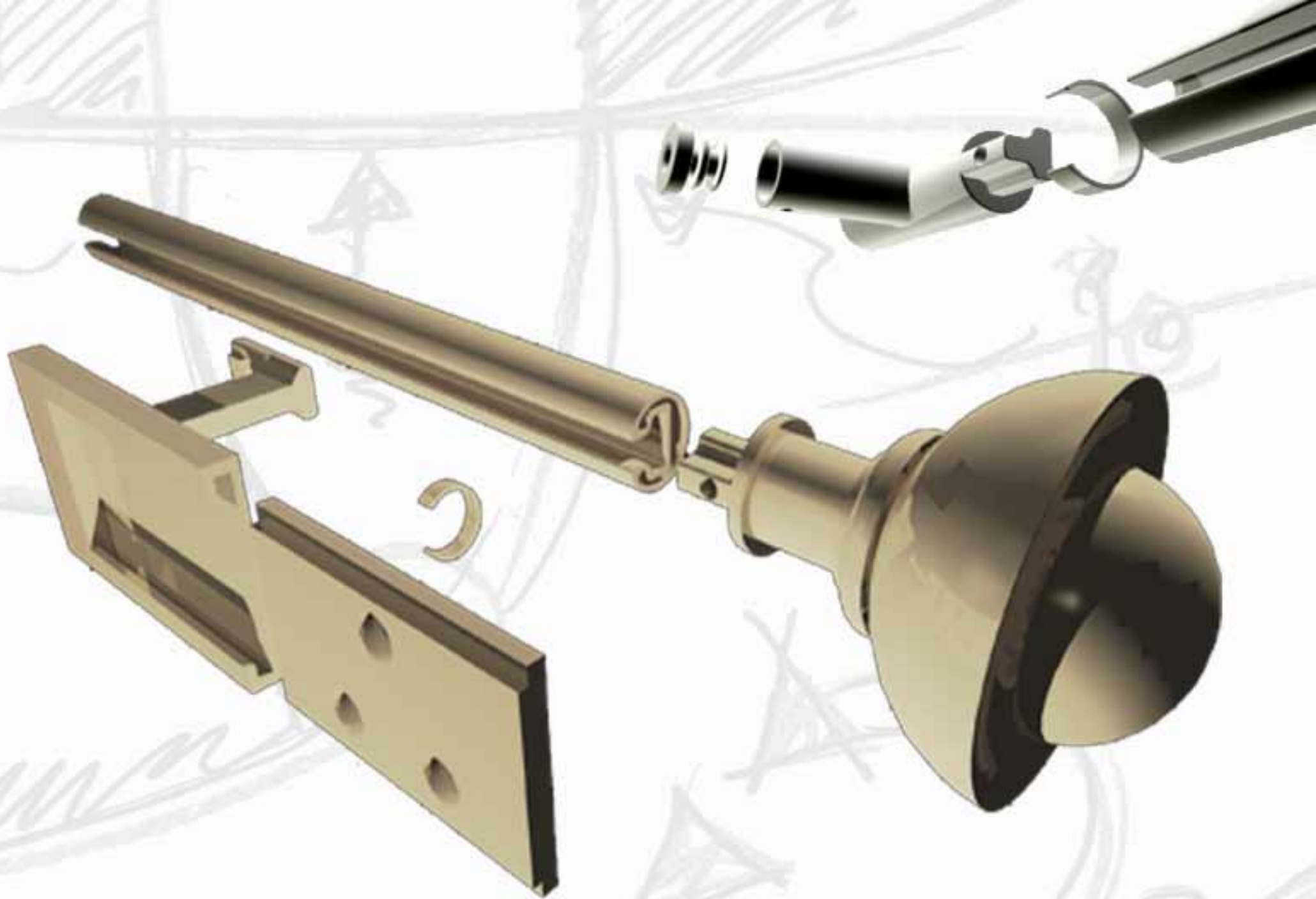

2006 / 7 / 8
PRODUCT

HOME CONNEXION (ITALY)

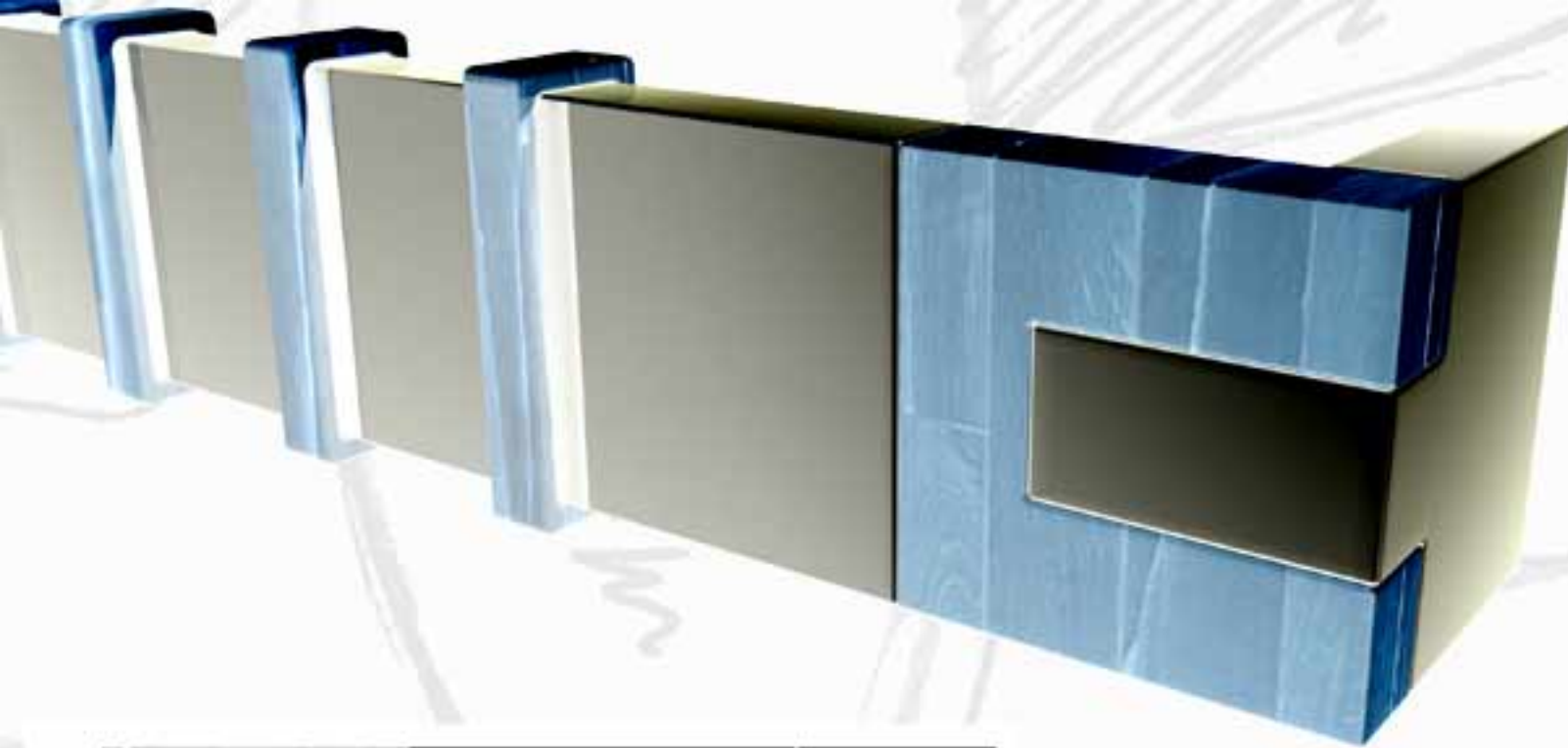

MINIMAL 1



G&S
CENTE



HOME CONNEXION (ITALY)

2006 / 7 / 8
PRODUCT



DEVINLEC
FRANCE

LEAD DESIGNER 2008

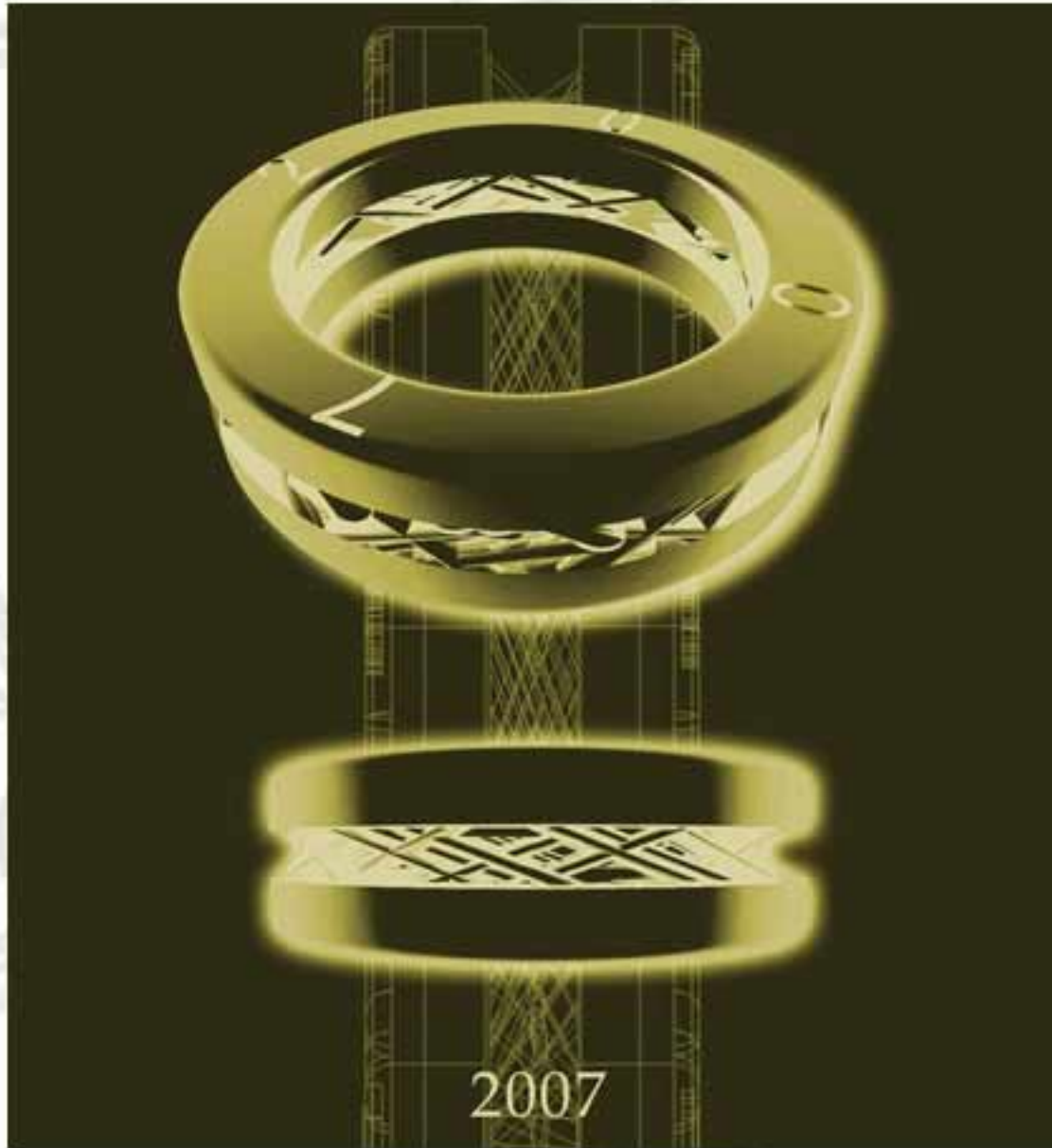

2007

2008
PRODUCT

DEVINLEC (FRANCE)

Antonio Longobardo



devinlec france

2008
PRODUCT

DEVINLEC (FRANCE)



ANTONIO LONGOBARDO

DESIGNER

nafkalina@hotmail.com

+66 087 921 7187