

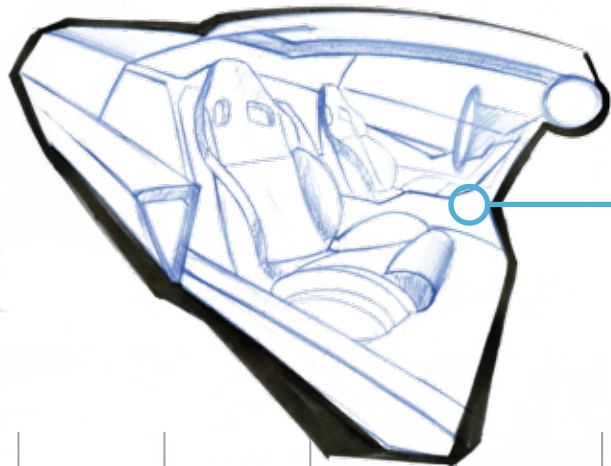

Jonathan Guayacundo

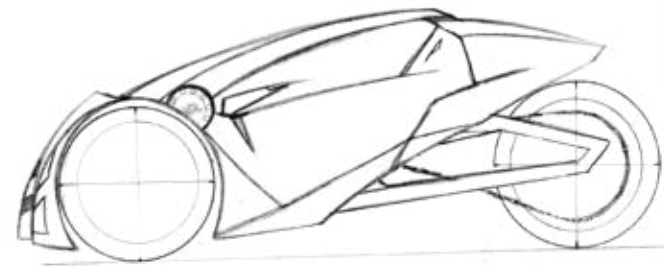

INTERIOR SEATS TWO PEOPLE

PANORAMIC ROOF

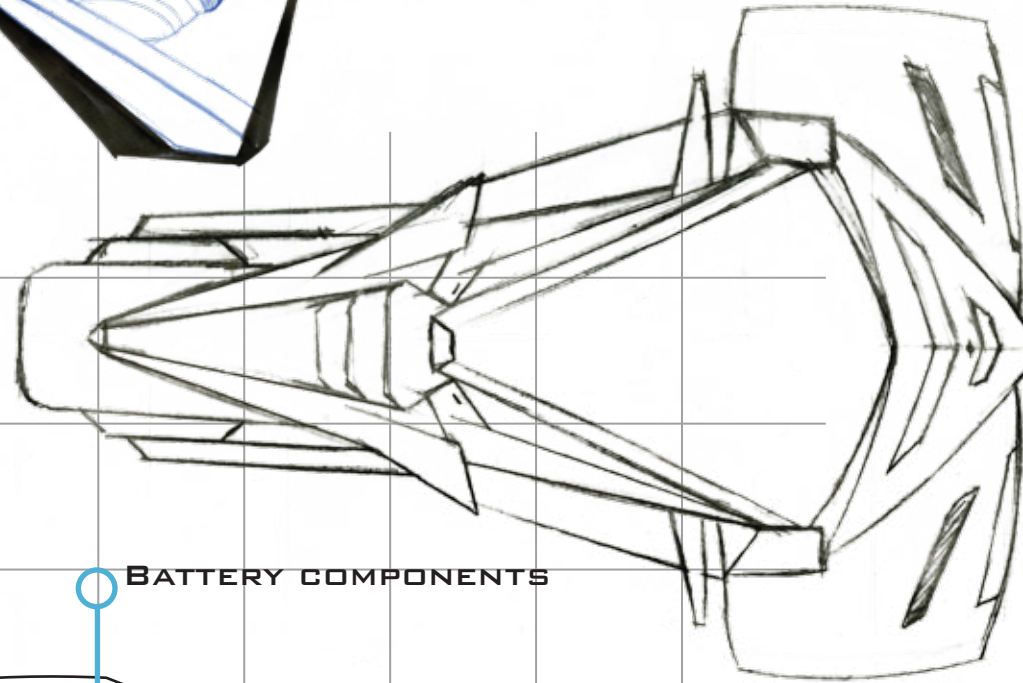
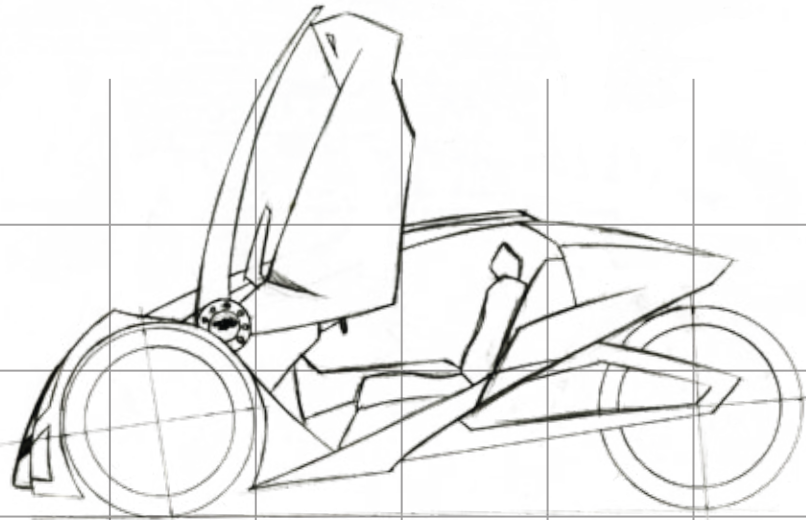
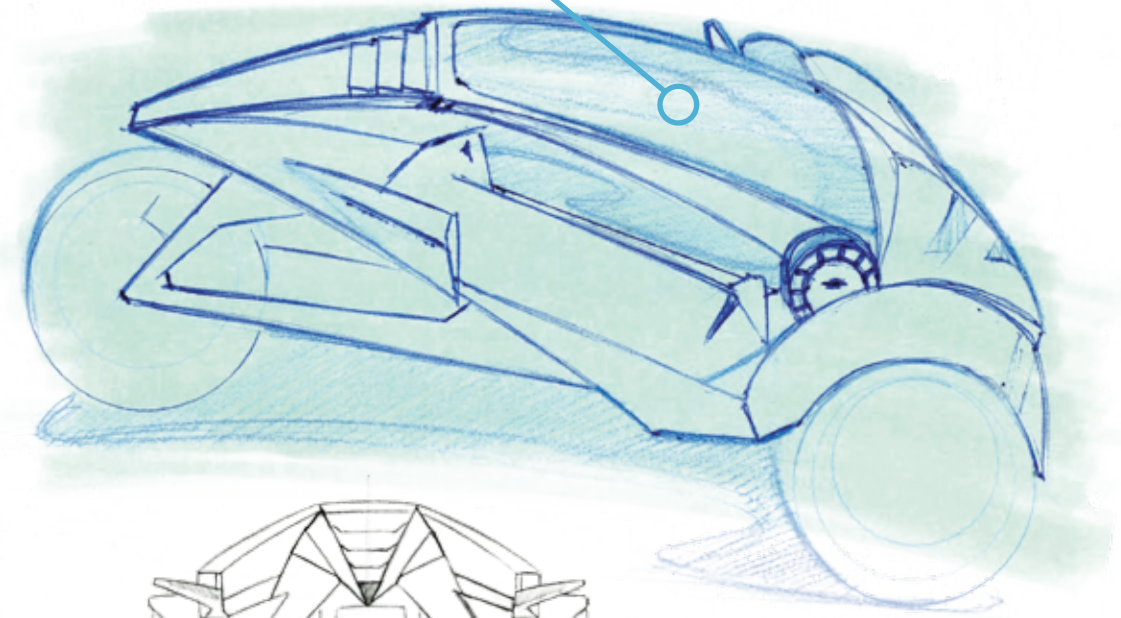

BATTERY COMPONENTS

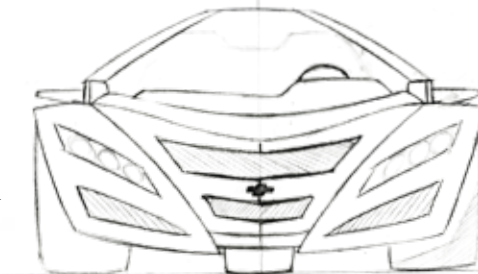
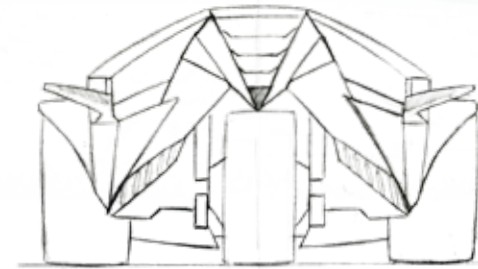

PANCAKE MOTOR

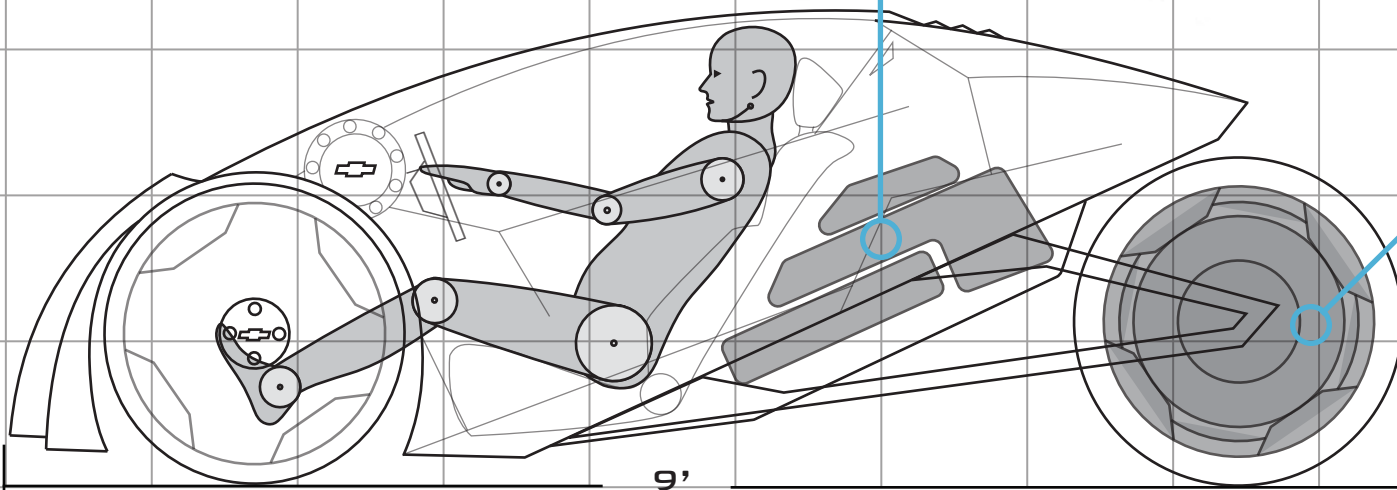

9'



# DELTA 13 CONCEPT

DELTA 13 IS A ELECTRIC 3 WHEELER CONCEPT FOR A LINE OF CARS FOR GM. THIS 3 WHEELER IS AN VEHICLE WHICH INCLUDES A PANCAKE MOTOR INSIDE THE REAR WHEEL. DELTA 13 STANDS ABOVE OTHER 3 WHEELER CONCEPTS OUT THERE BECAUSE IT CAN BE DRIVEN ALL YEAR LONG AND IT OFFERS COOL FEATURES LIKE A PANORAMIC ROOF.