

UNICOR

WORK BENCHES/TABLES, STORAGE, SHELVING, INDUSTRIAL RACKING, FOOD SERVICE, DORMITORY BEDS, DORMITORY BEDS AND ACCESSORIES



WARDROBES, CAFÉ TABLES, WIRE SHELVING, MEZZANINE SYSTEMS



www.unicor.gov

UNICOR METAL
PRODUCTS CATALOG

UNICOR PRODUCTS

UNICOR Offers a Wide Range of Industrial Products

It's easy to find products that work best for you, such as...

- Lockers for all personnel/staff needs
- Custom-fabricated products (prototype a product to your exact specifications)
- Ready-to-assemble shelving in an outstanding range of dimensions and sizes, shipped with fasteners for easy assembly with hand tools.
- Component parts, such as bins, drawers, and doors, that instantly increase the functionality of shelving.
- Racking, catwalks, and mezzanines for warehouse operations.
- Metal cabinets and lockers that are economical and durable.
- Depending on your project's complexity, design specialists can provide guidance over the phone, prepare sketches and estimates from a floor plan you provide, or even visit your site to develop a layout — for a nominal administrative charge.

The ultimate security: a full guarantee. UNICOR is committed to meeting your highest standards for performance. If at any time a product does not meet your expectations, UNICOR will promptly repair or replace it at no expense to you.

We invite you now to get to know UNICOR's quality metal products and the flexibility and versatility they offer. If you have any questions, please call UNICOR's Customer Service Center at 800 827-3168.

If you want a sales representative to call you...

If you need a quote...

If you need a design layout...

If you want assembly or installation of a metal product...

Just call UNICOR at 202 305-3707 or 859 225-4824 for the local contact nearest you.

LETTER TO OUR CUSTOMERS

UNICOR has been manufacturing top quality, durable metal products for more than 50 years. We are proud of our capabilities and are ready, willing, and able to put them to work for you.

We are convenient and easy to use. Since UNICOR is a government-established source, you need not waste valuable time with a prolonged procurement process. You can come directly to us. Additionally, you don't need a firm specification before you talk with us. We may even be able to suggest solutions to your needs.

**We are
committed to
your complete
and total
satisfaction**

All you have to do is give us a call.

This catalog is not intended to be all-inclusive. Rather, it is designed to give you an idea of our diverse product line. If you don't see exactly what you need, contact us and we will gladly

work with you to prototype a product to your exact specifications.

Your complete and absolute satisfaction is our top priority. We are committed to this goal. In fact, we are so sure you will be satisfied with our products and services that we offer the following "Escape-Proof" Guarantee.

We take great pride in teaching a good work ethic and marketable job skills. As a result, we produce high quality goods and services for our customers. We are committed to your complete and continual satisfaction. If, at any time, an item we have provided does not entirely meet your expectations, we will cheerfully and promptly repair or replace it, entirely at our expense.

LET US SHOW YOU WHAT WE CAN DO FOR YOU.

TABLE OF CONTENTS

How to Order	page 4
Terms and Conditions	page 2
Manufacturing Capabilities	page 3
How to Use This Catalog	page 6
Storage	page 8
Wardrobes and Cabinets	page 10
Sports Lockers	page 14
Work Benches/Tables	page 18
Café Tables	page 22
Steel Shelving	page 24
Steel Shelving Specifications and General Information	page 26
Open Steel Shelving Nut & Bolt . . .	page 30
Closed Steel Shelving Nut & Bolt . .	page 34
Nut & Bolt, Build Your Own or Expand Components	page 38
Steel Shelving, Nut & Bolt Accessories	page 44
Clip-Type Components	page 48
Counter Shelving Nut & Bolt	page 52
Ledge Shelving Nut & Bolt	page 54
Special Purpose Shelving	page 60
E-Z-Lock Shelving	page 62
Industrial Racking	page 66
Industrial Pallet Racking	page 68
Industrial Stacking Racks	page 78
Industrial Catwalk and Mezzanine Systems	page 80
Industrial Cantilever Racks	page 84
Food Service	page 88
Prep Tables	page 90
Miscellaneous	page 94
Additional Products	page 96
Dormitory Beds and Accessories . . .	page 98
Segregation Units and Accessories .	page 100
Metal Lumber and Miscellaneous . .	page 102

TERMS AND CONDITIONS

The Customer Service Center

Contact the FPI Customer Service Center for any questions or assistance regarding the information in this price list. Our business hours are 7:30 a.m. to 6:00 p.m. (EST), Monday through Friday (excluding federal holidays). Our phone number is **800 827-3168**.

Order Acknowledgment

FPI acknowledges every order. Orders are accepted, billed, and invoiced based on the information in this written order confirmation. Should you note any discrepancy, please advise us immediately. Your order acknowledgment indicates a due date when your product will arrive. In the event your products are manufactured earlier than scheduled, we will ship them upon completion, unless otherwise specified. Project level orders will be coordinated through our Project Managers.

Order Modifications

Modification to your purchase order will be accepted up to four weeks prior to the due date indicated on your order acknowledgment. However, if the revision results in a change in product availability, a new due date may be set by FPI. Such due date adjustments may be for your full purchase order, whether or not the specifications of all line-items on it are modified. All purchase order modifications are acknowledged in writing, including the annotation of any adjusted due date(s). Purchase order cancellations may result in a re-stocking fee.

Standard Lead Time

Typical lead time for product delivery is 90 days after receipt of your order.

Product Delivery and Pricing

We take both FOB Origin and FOB Destination orders. All products are shipped via surface transportation. On FOB Origin orders, title/product responsibility passes to the customer at the time of shipment. You may arrange your own transportation on FOB Origin orders, coordinating with FPI accordingly. Otherwise, your own order will be shipped by common carrier at your expense.

On FOB Destination orders, title/product responsibility passes to the customer upon delivery to the dock of the designated point of delivery. Freight charges are included in the product prices listed with a FOB Destination column.

Contact the Customer Service Center for destination prices where none are given. Such destination pricing for delivery outside the continental United States must be negotiated based on the freight rates at the time of shipment.

Services such as layout design, storage, inside delivery, and installation, and off-loading are not contained in this price list. Contact a technical representative at 202 305-3707 or 859 225-4824 for a quote on these services.

Geographic Coverage

All shipments for the continental United States include the 48 contiguous states and Washington, D.C.

Special Note on Overseas Shipments

All FOB Destination shipments are prepaid to the Port of Embarkation. All freight and handling charges beyond the port of embarkation are the responsibility of the local government purchasing facility, unless other arrangements are made through FPI. The freight charges for deliveries to Alaska, Hawaii, and foreign countries will be negotiated based on freight rates at the time of delivery. There is an additional 10% crating charge for orders not shipping to the 48 contiguous states. All shipments must include a physical address.

Special Packaging

Standard packaging varies per individual product. FPI will accommodate your special packaging requests; however, an upcharge may apply. Contact the Customer Service Center for more information.

Shipment Claims

FPI products are packaged to comply with carrier requirements. All shipments should be inspected by the consignee before acceptance. The delivering carrier should be requested to record any damage or shortage of items shipped. If any shortages are discovered, please notify the FPI Customer Service Center immediately.

Shipping damage and shortage claims must be filed with the carrier within 15 days of delivery. This applies to both FOB Destination and FOB Origin shipments. Carrier liability ends after 15 days for shipping damages or shortages.

Concealed Damage Claims

Claims for concealed damages must be filed with the carrier within 15 days after the delivery of goods. This applies to both FOB Destination and FOB Origin shipments. Carrier liability ends after 15 days for concealed damages.

Neither FPI nor the carrier will be responsible for damages if shipments are left unopened and/or claims are not filed within 15 days.

Product Storage

If necessary, FPI may store products at the factory at no expense to you for a period not to exceed 30 calendar days; however, such storage is predicated on the availability of our warehouse space at the time of need.

If FPI storage space is not available, or if you require storage in excess of 30 days, we will assist you in finding commercial storage alternatives at current market rates, at your expense.

Customer-Delayed Deliveries

Please notify the Customer Service Center at least two weeks prior to the confirmed due date when you cannot receive delivery of goods by that scheduled date. We will delay the delivery at your request; however, after 30 days of such delay, you will be invoiced for the subject products whether or not delivery is extended beyond the first 30 days.

FPI may allow up to two weeks for shipping. Therefore, if you do not request delayed delivery at least two weeks prior to the confirmed due date for arrival of your shipment, you may incur additional handling costs.

FPI will bill you for such handling costs if you refuse receipt of the goods, or request delayed shipment within less than two weeks prior to the due date on your order acknowledgment.

Product Returns

All product returns must be coordinated in advance with the FPI Customer Service Center. All freight or express service charges must be prepaid on return shipments.

Product returns may be subject to your being invoiced for additional handling/restocking fees. FPI will determine and notify you of such charges upon receipt and inspection of the returned goods.

Order Status

Call the Customer Service Center to obtain status of your order during order processing or the product and shipment/delivery of goods. We will give you the status based on your purchase order number and/or the FPI work order number on your order acknowledgment.

You may also access your order status by clicking on the customer service icon on our website at: www.unicor.gov.

Invoice Payment

Payments from government agencies should be addressed to:

FPI - FPI
P.O. Box 371736
Pittsburgh, PA 15252-7736

Payments from private sector parties should be addressed to:

FPI - LEX
Accounts Receivable
P.O. Box 11670
Lexington, KY 40583-3640

All general billing or specific invoice questions should be directed to the FPI Customer Service Center at **800 827-3168**.

Product Warranty

FPI guarantees all industrial products will be free from defects in materials and workmanship. If at any time an item we have provided does not meet your expectations, we will repair or replace it at our expense.

MANUFACTURING CAPABILITIES

Manufacturing Capabilities

UNICOR's metals factories offer a diverse array of metal fabrication capabilities. The broad range of equipment styles and capacities allows the metal factories to accommodate a wide variety of products from short run custom projects to multiyear contracts. Teamed with the expertise of the Product Support Center, the Industrial Products Group can work with your technical experts from product design through manufacturing start-up. As your partner in the Federal Government, we can work with your team to quickly bring products on line without the cumbersome restrictions of the solicitation process. Credit card and EDI capabilities are also on line at FPI to make working together as simple as possible. Below is a brief summary of our current manufacturing processes.

Stamping

Punch press capabilities range from turret presses capable of producing 1000 parts per hour to 500-ton presses with 10-foot beds. Part sizes range from 3" braces through shelving uprights up to 16 feet long. Metal thicknesses from 24-gauge (0.024) through 10-gauge (0.135) are commonly used. Although low carbon steel is the most frequently used material, aluminum, stainless steel, and other metals can also be fabricated. Automatic coil feeders are used where appropriate to maximize production efficiency. A variety of tooling options are available including permanent tooling, universal tooling, and steel rule dies. The proper tooling approach is selected based on complexity, production volume, and budget considerations. CNC turret presses are available for short to medium runs where permanent tooling is not feasible due to lead time or cost constraints.

Forming

Every UNICOR metal factory is equipped with a wide range of mechanical and hydraulic press brakes to handle most metal forming needs. Capacities up to 300 tons are available with 12-foot beds and CNC back-gauging for outstanding accuracy and consistency. A variety of standard tooling configurations are in stock, and custom tooling can be developed in-house for special shapes. Roll forming machines with integral punch presses and flying cut-off are also available for high volume requirements in items such as pallet rack uprights and beams.

Machining

Flexible CNC turret lathes and machining centers can quickly turn designs into finished products. By integrating the CNC machines with computer-aided drafting and design stations, part designs are quickly and accurately converted from concept to reality. Carbon steel, stainless steel, and aluminum are routinely used; and other metals can be processed as well.

Welding

Resistance welding, MIG, and TIG welding expertise are on line at all UNICOR metal factories. We routinely handle carbon steel, stainless steel, and aluminum. American Welding Society procedures are utilized and certification of welders is available. Resistance welding is used for sheet steel in the range of 24-gauge (0.024") to 16-gauge (0.060"). Arc, MIG, and TIG welding are used for heavier gauge plate and tubing.

Coating/Finishing Systems

The modern powder coating systems used by UNICOR provide an attractive and durable finish. First, a multistage wash system prepares the parts for painting. A phosphate coating for improved paint adhesion is included in the wash cycle. Parts are then routed through a dry off oven before entering the powder paint booths. Electrostatic paint application ensures a uniform coating even in hard to reach areas. The finish is then cured to the required gloss and hardness in carefully controlled ovens. The standard coating is an epoxy base; however, other coatings including polyesters, acrylics, and hybrids are available. Numerous standard colors are available, and we can match FED STD 595A COLOR CHART.

Tool and Die

Each UNICOR metal factory is equipped to build and maintain its own tooling. In addition, the Product Support Center provides expertise in tooling design and fabrication for complex projects requiring the use of CNC machining centers as well as electrodischarge machining (EDM). From complex progressive dies to universal tooling, UNICOR's tool and die staff have the expertise to select the most cost effective tooling for your program.

Services

To support our line of material handling products such as shelving and pallet racks, UNICOR offers complete layout and bill of material development including site visits if required. We can either use your layout or develop the layout from building measurements. UNICOR staff and inmates can quickly turn the floor plan into a detailed quotation and layout. Complete installation services are also available nationwide. In addition to assembly and installation of shelving and pallet racks, UNICOR can provide floor preparation and minor repair. We can also provide relocation service to move existing material handling equipment from one facility to another. Our expert installation crews will make sure your facility not only looks good but is ready to go to work on schedule.

UNICOR Metal Factory Locations

El Reno, Oklahoma: The El Reno facility is located about one half hour west of Oklahoma City. Its primary product lines are pallet racking, institutional beds, and casters. In addition to a variety of stamping, forming, and welding machinery, the El Reno factory is equipped with two large roll forming machines used to produce pallet rack beams and uprights. Two powder paint lines are available to paint parts up to 20 feet in length.

Lewisburg, Pennsylvania: The Lewisburg factory is located about one hour north of Harrisburg and is housed within the walls of a United States Penitentiary. This facility is primarily dedicated to producing a variety of metal stampings and welded assemblies to support other UNICOR factories. Other product lines include lockers, cabinets, and shelving. Lewisburg is equipped with a very versatile mix of stamping, forming, and welding machinery and has two powder paint lines capable of handling parts up to 54" by 84".

Pekin, Illinois: The Pekin factory is located about 15 minutes south of Peoria in central Illinois. This facility is unique compared to other UNICOR metal factories due to its capabilities in machining as well as stamping and forming. Its equipment includes a CNC turret lathe with automatic bar feed for parts up to 10" in diameter. A baked enamel paint systems allows for quick paint change-out for shorter production runs. This factory is also equipped with a new high speed turret press. Without the investment in expensive hard tooling, the turret press can fabricate prototypes or production runs of complex parts in a wide variety of sizes and metal gauges.

Terminal Island, California: This facility is located south of Los Angeles and produces shelving, lockers, and tables. The factory has substantial capability in stamping and forming, including press brakes up to 300 tons. Arc MIG welding and resistance welding of carbon steel are routinely performed, and two powder paint lines provide outstanding finishing capability.

We are very proud of our facilities and would welcome an opportunity to provide you with a tour of any one of the above factories. For more information, please call 202 305-3707 or 859 225-4824.

3

HOW TO ORDER

4



1

Call us toll-free at 800 827-3168.

Please have your credit card information ready if you are going to charge your purchase.

2

Fax your order to 859 254-9048.

Be sure to include all credit card information.

If you are paying by credit card, please include your credit card information on the order form. Your personal information will be kept confidential. Only UNICOR supervisory staff will process and ship credit card orders.

If at any time when ordering you have a question, or need additional information about the products or services contained within this catalog, please call 202 305-3707, 859 225-4824, or 405 262-4875 ext. 391 for assistance.

It's As Easy As ...

3

Mail your purchase order to:

UNICOR Customer Service Center
P.O. Box 11670
Lexington, KY 40577-1670

4

Order on the Internet:
www.unicor.gov

Click on Industrial Products on our home page for a list of most of the items in this catalog, or enter your stock number (product number) in our shops department to order your products. Have your credit card ready.

HOW TO USE THIS CATALOG

1

2



SHELVING Steel Shelving

Whether you choose our ready-to-assemble shelving packages, component parts for custom shelving, or the flexible clip-type shelving, UNICOR has the shelving you need. You'll find our merchandise strong and durable.

It's as easy as 1, 2, 3, 4 to specify your shelving. Refer to the following page for a graphic pictorial of each step.



1

Select from four styles and types:

- Nut and Bolt
- Clip-Type
- Wide Span
- Speciality

Each style offers a wide range of applications with many accessory items to maximize your storage requirements.

2

Choose a size:

UNICOR shelving is available in a wide range of depths, widths, and heights.

3

Determine a configuration:

UNICOR accepts customer-supplied layout and designs or offers assistance based on your available floor space. UNICOR staff will assist you in the selection of the style that best fits your requirements and will provide complete design and layout services of your storage areas, if requested.

Call 202 305-3707, 405 262-4875 ext. 391, or 859 225-4824 for assistance.

4

Determine load-bearing capacity:

UNICOR shelving is available in three classes of strength. Each class has a different weight capacity.

Internet Orders: www.unicor.gov

Toll-Free Phone Orders: 800 827-3168

2

3

6

4

5

SHELVING Steel Shelving Nut & Bolt Accessories

Flanged Bin Divider

Full height dividers are used to create small, individual storage bins within the shelving units, while angle and sliding dividers subdivide the shelf surface. Full height and angle dividers are fixed in place; sliding dividers are easily moved to accommodate changing storage needs.

Stock No.	Weight (LBS)	Dim. (D/W)	Price
SH9002	2.8	12" x 10"	\$2.85
SH9003	3.8	18" x 10"	\$2.80
SH9004	5.8	24" x 10"	\$2.75
SH9005	6.8	30" x 10"	\$4.75
SH9006	12.8	36" x 10"	\$5.20
SH9007	4.5	12" x 24"	\$3.65
SH9008	5.5	15" x 24"	\$4.20
SH9009	6.7	18" x 24"	\$4.85
SH9010	8.9	24" x 24"	\$6.85
SH9011	10.2	30" x 24"	\$7.20
SH9012	15.2	36" x 24"	\$8.40

FLANGED BIN DIVIDER

Stock No.	Weight (LBS)	Dim. (D/W)	Price
SH9013	2.9	12" x 6"	\$1.65
SH9014	4.2	18" x 6"	\$1.55
SH9015	5.5	18" x 6"	\$1.80
SH9016	21	24" x 6"	\$2.20

ANGLE BIN DIVIDER

Stock No.	Weight (LBS)	Dim. (D/W)	Price
SH9017	1.9	12" x 6"	\$1.20
SH9018	1.2	15" x 6"	\$1.20
SH9019	1.8	18" x 6"	\$1.25

Storage Drawers

Made from 20-gauge steel with combined pull handle/label holder for 1 1/2" x 3" cards. Each drawer has slots for dividers on 1" centers and stops to prevent drawers from falling when fully extended. Note: Two flush bars per shelf are recommended on shelf ends for all drawers to prevent drawers catching behind upright.

Stock No.	Description	Weight (LBS)	Dim. (D/W/H)	Price
SH9020	Drawer w/2 Dividers	4.3	30" x 17 1/2" x 4 1/2"	\$6.25
SH9021	Drawer 0-6"	4.3	30" x 17 1/2" x 4 1/2"	\$6.20
SH9022	Drawer w/2 Dividers	4.3	30" x 17 1/2" x 4 1/2"	\$6.20
SH9023	Drawer 0-6"	2.5	30" x 17 1/2" x 4 1/2"	\$6.10
SH9024	Drawer w/2 Dividers	6.3	114" x 17 1/2" x 4 1/2"	\$12.20
SH9025	Drawer 0-6"	6.3	114" x 17 1/2" x 4 1/2"	\$12.25

Label Holders

Made from 22-gauge steel, holders are 1" high with edges turned back to accommodate a 1/2" label. Two holes at each end and one in center match holes in shelf face with self-inserting clips for easy fastening. For shelves 24" to 48" wide.

Stock No.	Weight (LBS)	Dim. (D/W)	Price
SH9026	0.3	24"	\$1.20
SH9027	0.4	30"	\$1.20
SH9028	0.5	36"	\$1.20
SH9029	0.6	42"	\$1.20
SH9030	0.7	48"	\$1.20

ACCESSORIES: LABEL HOLDER

Stock No.	Weight (LBS)	Dim. (D/W)	Price
SH9031	0.3	24"	\$1.20
SH9032	0.4	30"	\$1.20
SH9033	0.5	36"	\$1.20
SH9034	0.6	42"	\$1.20
SH9035	0.7	48"	\$1.20

Drawer Dividers

Drawers have two dividers each, for use in 36" wide shelving units with depths of either 22" or 18". Dividers are made of 22-gauge steel, are adjustable on 1" centers, and accommodate label inserts 1/2" high.

Stock No.	Description	Weight (LBS)	Dim. (D/W)	Price
SH9036	Drawer 0-6"	6.2	30" x 17 1/2"	\$12.25
SH9037	Drawer 0-6"	5.1	30" x 17 1/2"	\$12.20

26-Drawer and 24-Drawer Inserts

Overall dimensions are 12 1/2" x 6 1/2" x 3 3/4" for use in shelving units 36" wide. Made for 12" and 18" shelf depths, drawers have two dividers each, adjustable on 1" centers, and accommodate label inserts 1/2" high. Drawers are designed to prevent falling when fully extended.

Stock No.	Description	Weight (LBS)	Dim. (D/W)	Price
SH9038	18-Drawer for 12" Shelf	85.1	101" x 24"	\$202.00
SH9039	Drawer 0-6"	5.8		\$1.20
SH9040	18-Drawer for 18" Shelf	115.2	101" x 24"	\$232.00
SH9041	24-Drawer for 18" Shelf	105	101" x 24"	\$202.00
SH9042	Drawer 0-6"	6.1		\$1.20
SH9043	24-Drawer for 12" Shelf	98	101" x 24"	\$202.00

ACCESSORIES: MULTI-DRAWER INSERTS

Stock No.	Description	Weight (LBS)	Dim. (D/W)	Price
SH9044	18-Drawer for 12" Shelf	85.1	101" x 24"	\$202.00
SH9045	Drawer 0-6"	5.8		\$1.20
SH9046	18-Drawer for 18" Shelf	115.2	101" x 24"	\$232.00
SH9047	24-Drawer for 18" Shelf	105	101" x 24"	\$202.00
SH9048	Drawer 0-6"	6.1		\$1.20
SH9049	24-Drawer for 12" Shelf	98	101" x 24"	\$202.00

Color Selection:

1 - Select a finish color.

2 - Place 2-digit color code at end of stock no.

Grey	29	Pumkin	08	Black	27	Sand	28	Light Grey	53
------	----	--------	----	-------	----	------	----	------------	----

Additional colors may be available. Please call 202 305-3707 or 859 225-4824 for more information.

All pricing is FOB origin.

Internet Orders: www.unicor.gov / Toll-Free Phone Orders: 800 827-3168

6

9

7

8

10

The new 2001 Metals Catalog has been redesigned and simplified. Our customers will now be able to place orders directly from this catalog without having to refer to a separate Price List. Sizing and specifications of products have been clearly explained. All the necessary information can be had at a glance, in one location. We think you'll be very pleased.

- 1.** The new 2001 Metals Catalog is divided into six product line groups; Storage, Work Benches and Tables, Steel Shelving, Industrial Racking, Food Service, and Additional Products.
- 2.** The pages in each group are color coded and titled for clarity.
- 3.** Opening pages have information specific to each product line group.
- 4.** Interior pages of these sections are designed to make ordering simple.
- 5.** Descriptive copy and color photos are visually linked together with arrows.
- 6.** Charts contain ordering, shipping, and pricing information.
- 7.** Colors available for any given product are represented on each page along with its 2-digit color code.
- 8.** Color choices are made by the customer and the 2-digit color code must be added to the end of the stock number when ordering.
- 9.** Other specific information, such as technical support, custom work, and load bearing capacity, can be found in the tinted color panels.
- 10.** Web site and toll-free number.

STORAGE

UNICOR manufactures a multiple range of storage products. Our construction is sturdy, durable, and secure. There are a vast array of colors available and handle and door options to meet all of your storage needs.



UNICOR Offers a Wide Range of Storage Products

Wardrobe and Utility Storage Cabinets

UNICOR offers a wide range of flexibility and choice in the wardrobe and utility storage cabinets line. The applications for which these products can be used is endless, from the front office to the warehouse and barracks. Institutional wardrobes and storage lockers have been a UNICOR specialty for years.

Sports Lockers

From personal storage lockers to sports lockers, UNICOR has the styles and options you need. Choose from standard widths of 12", 15", 18", and 36"; configurations ranging from single-door units to 16-person sports lockers; and options like sloped tops and bases that make your lockers right for your space. UNICOR lockers are made of sturdy 24-gauge steel, with 22-gauge tops and bottoms and 16-gauge doors. Lockers are available assembled or unassembled.

Internet Orders:

www.unicor.gov

Wardrobe and Utility Storage Cabinet Door Styles:



solid door

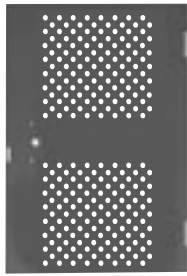

perforated door
(available on lockers only)



louvered door

Handle Types:

- *lever handle*
 - *squeeze latch handle*
 - *lift handle*
- (handles not shown)*



Office Storage

UNICOR has a complete line of filing storage products—from vertical to lateral, from stationary to mobile. There are standard offerings as well as design- your-own.

The office storage products are not available in this catalog. They can be found in the Opus Metals Furniture Catalog (CAT#P600 and CATPP600). Just call the Customer Service Center at 800 827-3168 to request.



STORAGE

Wardrobes and Cabinets

87" "Marine Corps" Locker (Wardrobe)

Originally designed for the Marine Corps, this two-door, 22-gauge wardrobe features upper and lower shelves, full-width coat rod, four hooks, reinforced doors, towel bars on each door, padlock hasp, hat shelf, and label holder mounted on the door. It has tamper-proof bolts. Equipped with lift-type handles with padlock eye for added security (padlock not included). An optional security lock box made of 11-gauge steel can be bolted in place into the lower storage area with tamper-proof bolts. The locker is shipped fully assembled. Size: 36"W x 24"D x 87"H.



solid door/lift handle

"MARINE CORPS" LOCKER (WARDROBE)

Stock No.	Description	Dim. (W/D/H)	Weight (LBS)	Price
MCLU243687 □□	Locker Storage Unassembled (gray only)	36" x 24" x 87"	265	\$379.00
SLB1385 □□	Security Lock Box Assembled (gray only)	8" x 13" x 5"	12	\$59.00

10

1 Select a finish color.

2 Place 2-digit color code at end of stock no.

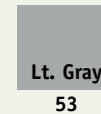
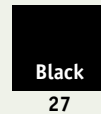
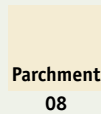
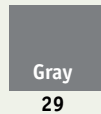

Additional colors may be available. Please call 202 305-3707 or 859 225-4824 for more information.

Double-Door Cabinet (Wardrobe)

This wardrobe is an excellent choice for storing clothing and personal items. It is made of heavy 22-gauge steel with 16-gauge double doors. The four removable shelves on the left side are adjustable on half-inch centers. The wardrobe also comes with a center half-inch partition, a full-width coat rod, hat shelf, two towel bars, two clothes hooks, a label holder mounted on the door, and an inside mirror on the right door. Comes with squeeze latch locking hardware with a two-point latch mechanism. It has two rear legs. The double-louvered doors are designed for padlock use. It is shipped unassembled. Size: 30"W x 21"D x 78"H.



louver door/squeeze latch handle

84" Drawer Locker (Wardrobe)

Providing all the comforts of home, this 3-drawer, 22-gauge steel wardrobe includes two small drawers and a full-width drawer for small items. Drawers operate on four adjustable rollers or glides. Wardrobe section has a coat rod and two coat hooks, with a separate shelf above. Double 16-gauge steel doors are louvered for ventilation. Equipped with lift-type handles with padlock eye for added security (padlock not included). Included are label holders and a number plate. Shipped unassembled; assembled drawer units shipped separately. Size: 36"W x 24"D x 84"H.



louver door/lift handle

DOUBLE-DOOR CABINET (WARDROBE)

Stock No.	Description	Dim. (W/D/H)	Weight (LBS)	Price
DDL213078 □□	Unassembled	30" x 21" x 78"	193	\$319.00

84" DRAWER LOCKER (WARDROBE)

Stock No.	Description	Dim. (W/D/H)	Weight (LBS)	Price
WLKU243684 □□	Unassembled	36" x 24" x 84"	322	\$319.00

Double-Door Storage Cabinet

This double-door metal storage cabinet holds six adjustable shelves for storing supplies in stockrooms, toolrooms, warehouses, and offices. The shelves are supported on two-inch centers, the full width of the cabinet. The heavy gauge steel cabinet has 20-gauge steel double doors. Comes with squeeze latch locking hardware with a two-point latch mechanism. Cabinet is shipped unassembled but can be shipped assembled at an additional cost. Size: 36"W x 18"D x 64"H and 36"W x 18"D x 78"H.

DOUBLE-DOOR STORAGE CABINET

Stock No.	Description	Dim. (W/D/H)	Weight (LBS)	Price
DDSC183664 <input type="checkbox"/>	Unassembled	36" x 18" x 64"	126	\$199.00
DDSC183678 <input type="checkbox"/>	Unassembled	36" x 18" x 78"	150	\$209.00

Double-Door Storage/Wardrobe Cabinet

Constructed of 22-gauge steel, this combination unit offers both shelf and wardrobe storage. The cabinet offers six adjustable shelves on the left half and a coat rod on the right half. Shelves are adjustable on 2-inch centers that do not require tools or separate clips. It features flush-mounted squeeze latch locking hardware with a two-point latch mechanism. An attractive as well as durable wardrobe, this cabinet has a powder epoxy finish. Size: 36"W x 18"D x 64"H and 36"W x 18"D x 78"H.

DOUBLE-DOOR STORAGE/WARDROBE CABINET

Stock No.	Description	Dim. (W/D/H)	Weight (LBS)	Price
DSCW183664 <input type="checkbox"/>	Double-Door Storage/Wardrobe Cabinet (unassembled)	36" x 18" x 64"	124	\$209.00
DSCW183678 <input type="checkbox"/>	Double-Door Storage/Wardrobe Cabinet (unassembled)	36" x 18" x 78"	146	\$219.00



solid door/lift handle



solid door/padlock-ready handle



solid door/squeeze latch handle



solid door/squeeze latch handle

Storage Locker

This compact wardrobe can be stacked in factories and stockrooms, using bolted construction. Made of heavy 22-gauge steel, it has 16-gauge double doors for extra durability. The interior features a coat rod, two hooks, and two shelves, and the louvered back provides ventilation. Double doors have a padlock-ready handle. Shipped assembled. Available in two sizes: 24"W x 18"D x 40"H and 24"W x 18"D x 60"H.

STORAGE LOCKER

Stock No.	Description	Dim. (W/D/H)	Weight (LBS)	Price
SSLU182440 <input type="checkbox"/>	Assembled	24" x 18" x 40"	90	\$179.00
*SSLU182440 <input type="checkbox"/>	Storage Locker, Personal	24" x 18" x 40"	90	\$229.00
SSLU182460 <input type="checkbox"/>	Assembled	24" x 18" x 60"	110	\$190.00

* This is a QuickShip item and can be sent to you within 30-days. Available in gray, color code 29. Price is FOB Destination.

Contemporary Double-Door Wardrobe Cabinet

Constructed of 22-gauge steel, this double-door wardrobe cabinet is perfect for storing clothing. It features flush-mounted, squeeze latch locking hardware with a two-point latch mechanism. A durable and attractive wardrobe, this cabinet has a powder epoxy finish and a full-width coat rod. Size: 36"W x 18"D x 64"H and 36"W x 18"D x 78"H.

CONTEMPORARY DOUBLE-DOOR WARDROBE CABINET

Stock No.	Description	Dim. (W/D/H)	Weight (LBS)	Price
CABU183664 <input type="checkbox"/>	Unassembled	36" x 18" x 64"	97	\$159.00
CABU183678 <input type="checkbox"/>	Unassembled	36" x 18" x 78"	119	\$169.00

STORAGE

Wardrobes and Cabinets

Contemporary Single-Door Storage

UNICOR constructs this storage unit of 22-gauge steel. It features six shelves that are adjustable on two-inch centers that do not require tools or separate clips. Flush-mounted, squeeze latch locking hardware with a two-point latch mechanism provides superb protection.

CONTEMPORARY SINGLE-DOOR STORAGE

Stock No.	Description	Dim. (W/D/H)	Weight (LBS)	Price
CSSU181864	Unassembled	18" x 18" x 64"	79	\$159.00
CSSU181878	Unassembled	18" x 18" x 78"	96	\$169.00

Single-Door Clothing Locker

Durable and functional, this wardrobe is ideal for storing clothing and personal items in barracks, gymnasiums, schools, hospitals, or shops. The wardrobe is made of heavy gauge steel with a 16-gauge steel door set in a rigid angle frame. The single-tier wardrobe comes with legs and a semilouvered door for ventilation. It is equipped with four coat hooks, coat rod, hat shelf, and lift-type handle with padlock eye for added security (padlock not included). Wardrobe has a number plate for identification. The wardrobe comes in 4 sizes, both unassembled and assembled.

12

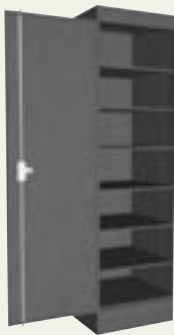

solid door/squeeze latch handle



solid doors/squeeze latch handles



louver door/lift handle

Contemporary Single-Door Wardrobe

This wardrobe offers you a choice of a left- or right-opening door that features flush-mounted, squeeze latch locking hardware with a two-point latch mechanism.

CONTEMPORARY SINGLE-DOOR WARDROBE

Stock No.	Description	Dim. (W/D/H)	Weight (LBS)	Price
CSWU181864R	Unassembled, Right	18" x 18" x 64"	62	\$129.00
CSWU181864L	Unassembled, Left	18" x 18" x 64"	62	\$129.00
CSWU181878	Unassembled, Right	18" x 18" x 78"	76	\$139.00

SINGLE-DOOR CLOTHING LOCKER

Stock No.	Description	Dim. (W/D/H)	Weight (LBS)	Price
LSCU211878	Unassembled	18" x 21" x 78"	103	\$149.00
LSCA211878	Assembled	18" x 21" x 78"	117	\$169.00
LSCU241878	Unassembled	18" x 24" x 78"	106	\$149.00
LSCA241878	Assembled	18" x 24" x 78"	120	\$169.00
LSCU181578	Unassembled	15" x 18" x 78"	89	\$149.00
LSCU211872	Unassembled	18" x 21" x 72"	98	\$149.00

Single-Door Wardrobe Cabinet

This cabinet is amply sized but takes up little space. The cabinet door is made of 20-gauge steel; is equipped with a hat rack, and a coat rod the full width of the cabinet; and is secured with a self-contained locking handle. The cabinet is shipped unassembled, but can be shipped assembled at an additional cost. Offered with right-hand doors only.



solid door/lift handle

SINGLE-DOOR WARDROBE CABINET

Stock No.	Description	Dim. (W/D/H)	Weight (LBS)	Price
CABU182478 □□	Unassembled	24" x 18" x 78"	130	\$189.00
CABA182478 □□	Assembled	24" x 18" x 78"	130	\$209.00

1 Select a finish color.

2 Place 2-digit color code at end of stock no.

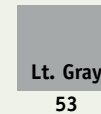
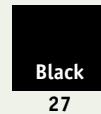
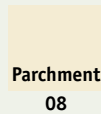
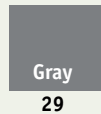

Additional colors may be available. Please call 202 305-3707 or 859 225-4824 for more information.

Double Clothing Locker

The double wardrobe is two single wardrobes with legs, joined by a common center wall. The wardrobes are made of heavy gauge steel. Wardrobes come with semilouvered doors for ventilation, a number plate for identification, and lift-type handle with eye for padlock, combination lock, or key lock (lock not included). Bolted construction adds durability.



louver door/lift handle

DOUBLE CLOTHING LOCKER

Stock No.	Description	Dim. (W/D/H)	Weight (LBS)	Price
DCLU213678 □□	Unassembled	36" x 21" x 78"	198	\$259.00
DCLA213678 □□	Assembled	36" x 21" x 78"	215	\$279.00
DCLU243678 □□	Unassembled	36" x 24" x 78"	200	\$259.00
DCLA243678 □□	Assembled	36" x 24" x 78"	218	\$279.00

STORAGE

Sports Lockers

SPORTS LOCKERS

From personal storage lockers to sports lockers, UNICOR has the styles and options you need. Our lockers are made of sturdy 24-gauge steel, with 22-gauge tops and bottoms and 16-gauge doors. Our sports lockers are manufactured with a variety of door styles, handles, locks, and other accessories.

Door Styles

Choose from standard, high-privacy louvered, or solid openings, or opt for the greater ventilation of louvered or perforated patterns — especially good for use in fitness centers.

Handles and Locks

Take your choice of recessed handles with two-point latching and key locks, or rotating handles with three-point latching or standard padlock hasps. Keyed units can be provided with an optional master key (available on single and two-tier only). Other lockers offer padlock only.

Handles and Locks:

- recessed handled two-point latch
- rotating handles with three-point latch
- standard padlock hasp

(handles and locks not shown)

14

Door Styles:

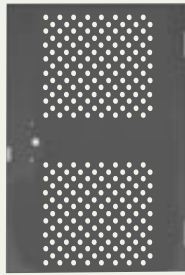

perforated door



louvered door



solid door

Sports Lockers Accessories

Sloped Tops

Keep your locker tops free of extra belongings and dirt with these sloping tops for single-tier lockers or upper units of multi-tier lockers. Use rear supports to attach.

Closed Bases

These base pieces keep dust and debris from collecting beneath lockers. Front and end bases easily attach to lockers and are available for all lockers with support legs.

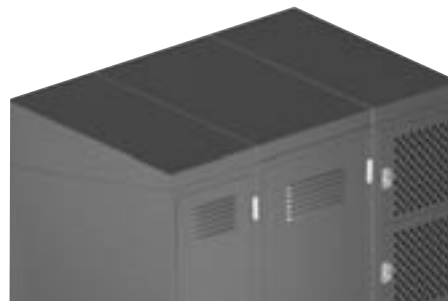

sloped top



closed base



Single Lockers with Louvered Doors

SINGLE LOCKERS WITH LOUVERED DOORS

Stock No.	Description	Dim. (W/D/H)	Price
LCS91012 □□	Assembled w/legs	18" x 21" x 78"	\$202.80
LCS91013 □□	Unassembled	18" x 21" x 78"	\$149.00
LCS91014 □□	Assembled w/legs	18" x 24" x 78"	\$169.00
LCS91015 □□	Unassembled	18" x 24" x 78"	\$149.00
LCS91016 □□	Unassembled	18" x 18" x 78"	\$149.00
LCS91017 □□	Unassembled wo/legs	18" x 21" x 72"	\$149.00
LCS96015 * □□	Assembled w/legs	12" x 18" x 78" *	\$149.00
LCS96016 □□	Unassembled	12" x 18" x 78" *	\$129.00

*Call about special shipping requirements. Slope top kit = \$19

Note: Perforated doors available as an option only on 4- and 6-tier lockers.

1 Select a finish color.

2 Place 2-digit color code at end of stock no.

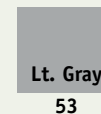
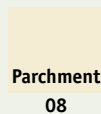
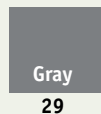

Additional colors may be available. Please call 202 305-3707 or 859 225-4824 for more information.

Single-Door Clothing Locker

In 15" or 18" widths, 18" or 21" depths, and an overall height of 78" with legs or 72" without legs, these lockers are made of sturdy steel and feature a lever-style handle that accommodates a padlock.

SINGLE-DOOR CLOTHING LOCKER

Stock No.	Description	Dim. (W/D/H)	Weight (LBS)	Price
LCSU211878 □□	Unassembled	18" x 21" x 78"	103	\$149.00
LCSA211878 □□	Assembled	18" x 21" x 78"	117	\$169.00
LCSU241878 □□	Unassembled	18" x 21" x 78"	106	\$149.00
LCSA241878 □□	Assembled	18" x 21" x 78"	120	\$169.00
LCSU211872 □□	Unassembled	18" x 21" x 72"	98	\$149.00
LCSU181578 □□	Unassembled	15" x 18" x 78"	89	\$149.00



STORAGE

Sports Lockers

MULTITIER LOCKERS

From personal storage lockers to sports lockers, UNICOR has the styles and options you need. Choose from standard widths of 12", 15", 18", and 36"... configurations ranging from single door units to 16-person sports lockers...and options like sloped tops and bases that make your lockers right for your space. UNICOR lockers are made of sturdy 24-gauge steel, with 22-gauge tops and bottoms and 16-gauge doors. Lockers can be provided assembled.

Note: Perforated doors available as only option on 4- and 6-tier lockers.

FOUR-TIER LOCKERS WITH LEGS AND LOUVERED DOORS

Stock No.	Description	Dim. (W/D/H)	Price
LCS95005 <input type="checkbox"/>	Assembled w/legs	12" x 18" x 78"	\$179.00
LCS95006 <input type="checkbox"/>	Unassembled w/legs	12" x 18" x 78"	\$159.00

**Ideal where space is at a premium*

16



2-tier locker with louvered doors



4-tier locker w/legs and perforated doors



multi-tier locker w/solid base and perforated doors

TWO-TIER LOCKER WITH LOUVERED DOORS

Stock No.	Description	Dim. (W/D/H)	Price
LCS95004 <input type="checkbox"/>	Louvered, Assembled w/legs	15" x 18" x 78"	\$189.00
LCS95002 <input type="checkbox"/>	Louvered, Unassembled w/legs	15" x 18" x 78"	\$169.00
LCS95003 <input type="checkbox"/>	Louvered, Assembled w/legs	12" x 18" x 78"	\$189.00
LCS95001 <input type="checkbox"/>	Louvered, Unassembled w/legs	12" x 18" x 78"	\$169.00

Front Base: \$6.30 each. End Base: \$7.75 each (see chart at right)

FOUR-TIER LOCKERS WITH LEGS AND PERFORATED DOORS

Stock No.	Description	Dim. (W/D/H)	Price
LCS95007 <input type="checkbox"/>	Assembled w/legs	12" x 18" x 78"	\$179.00
LCS95008 <input type="checkbox"/>	Unassembled w/legs	12" x 18" x 78"	\$159.00

SIX-TIER LOCKERS WITH LEGS AND LOUVERED OR PERFORATED DOORS

Stock No.	Description	Dim (W/D/H)	Price
LCS95009 <input type="checkbox"/>	Louvered, Assembled w/legs	12" x 18" x 78"	\$189.00
LCS95010 <input type="checkbox"/>	Louvered, Unassembled w/legs	12" x 18" x 78"	\$169.00
LCS95011 <input type="checkbox"/>	Perforated, Assembled w/legs	12" x 18" x 78"	\$189.00
LCS95012 <input type="checkbox"/>	Perforated, Unassembled w/legs	12" x 18" x 78"	\$169.00

Front Base: \$6.30 each. End Base: \$7.75 each (see chart at right)

16-PERSON LOCKER

Stock No.	Description	Dim. (W/D/H)	Price
L16LDKLD □□	Louvered, Unassembled w/legs	72" x 18" x 78"	\$529.00
L16LDKLSU □□	Louvered, Assembled w/legs	72" x 18" x 78"	\$629.00
L16PDKLD □□	Perforated, Unassembled w/legs	72" x 18" x 78"	\$529.00
L16PDKLSU □□	Perforated, Assembled w/legs	72" x 18" x 78"	\$629.00

Front base: \$6.30 each

End base: \$7.75 each (see chart below right)

Specify base width of 12"

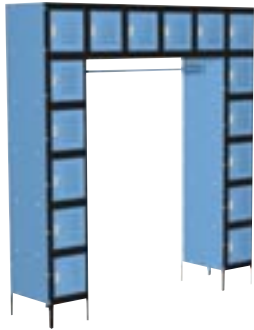

16-person locker w/legs and louvered doors

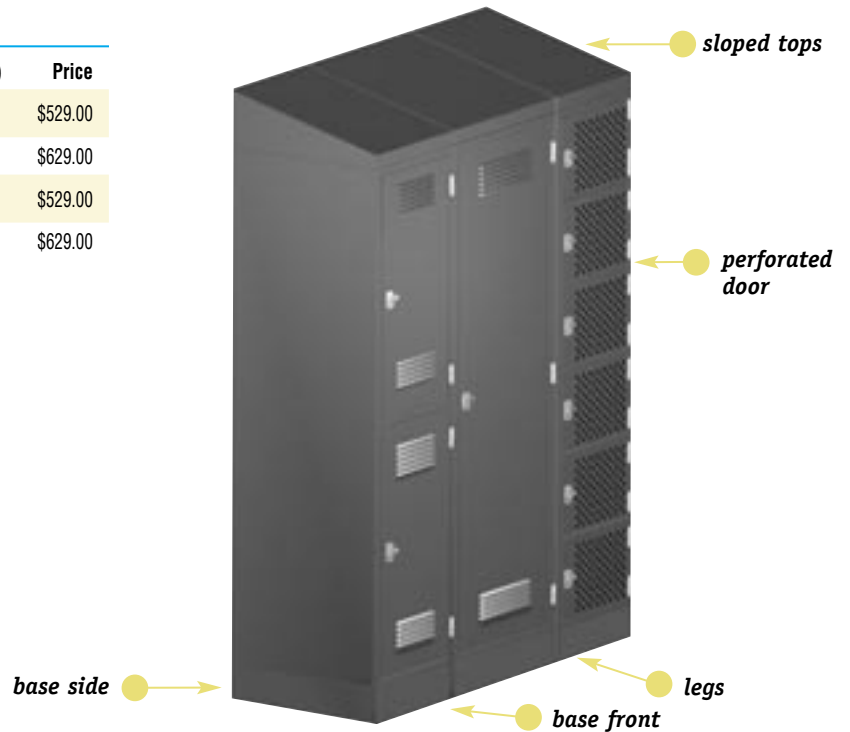

1 Select a finish color.

2 Place 2-digit color code at end of stock no.

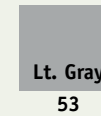
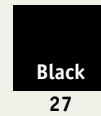
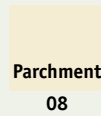

Additional colors may be available. Please call 202 305-3707 or 859 225-4824 for more information.

Heavy-Duty Storage Locker

Our heavy-duty storage locker features fully welded construction for use in areas where extra security and durability are desired. Locker is 24" deep, 48" wide, and 72" tall, and features a 30" wide door with padlockable sliding barrel bolt. Locker is fabricated from 1" steel square tubing and 16-gauge perforated panels. Interior features one solid 14-gauge shelf plus four side shelves that are fixed. Included is a 30" clothes rod. Standard color is black, but other colors are available upon request. Shipping weight is 346 lbs.



HEAVY-DUTY STORAGE LOCKER

Stock No.	Description	Dim. (W/D/H)	Price
LKR0305 □□	Storage Locker w/30" door (open mesh)	48" x 24" x 72"	\$525.00

SPORTS LOCKER ACCESSORIES

Stock No.	Description	Dim. (W)	Price
BSFT12 □□	Base Front	12"	\$6.30
BSFT15 □□	Base Front	15"	\$6.30
BSFT18 □□	Base Front	18"	\$6.30
BSSD18 □□	Base Side	18"	\$7.75
BSSD21 □□	Base Side	21"	\$7.75
BSSD24 □□	Base Side	24"	\$7.75
Stock No.	Description	Dim. (W/D)	Price
SLTP1218 □□	Sloped Top	12" x 18"	\$19.00
SLTP1221 □□	Sloped Top	12" x 21"	\$19.00
SLTP1224 □□	Sloped Top	12" x 24"	\$19.00
SLTP1518 □□	Sloped Top	15" x 18"	\$19.00
SLTP1521 □□	Sloped Top	15" x 21"	\$19.00
SLTP1524 □□	Sloped Top	15" x 24"	\$19.00

WORK BENCHES / TABLES



18

Work Benches

UNICOR work benches are the ideal solution for standing workstations that require ample storage of supplies or work material. The heavy-duty construction provides an extremely solid base for any type of assembly operation.

Components or Complete Units

These work benches provide a secure and stable work surface for work of all types, and may be ordered by component parts or as a complete unit shown on this page.

Internet Orders:

www.unicor.gov

UNICOR modular work benches offer the stability of a rock-solid work surface with the addition of secure storage below for tools, instruments, or other essentials. A great feature is the flexibility with which they can be configured. For more information on configuration and custom applications, contact our technical representative at 202 305-3707 or 859 225-4824.



work bench with metal top

Platform-Topped Work Benches

Get back to basics the smart way, with UNICOR's sturdy platform-topped work benches. Steel-only tabletop materials are used, and you can accessorize with drawers, back and end stops, risers, lower shelf, or electrical outlet strips. Then choose a leg design: fixed or adjustable, in the basic height you require. Adjustable legs range from 30" to 36" high, and adjust on 1" centers. Legs are pre-punched for tabletop, horizontal stringer (stabilizer), floor anchoring, and shelf attachments, and have knockouts for electrical outlets. Available in sizes from 60"W x 28"D x 28"H to 72"W x 34"D x 34"H.

Basic Work Bench

Select to the height you need or customize to any application with the addition of accessories. Leg adjustments, height adjustment sleeve, floor plate, height adjustment sleeve with caster base, rigid caster, swivel caster with brake, back/end stops.

WORK BENCHES / TABLES

WORK BENCH CONFIGURATION A

Units include legs, steel top, and stringer.

Stock No.	W	D	H	Weight (LBS)	Price
RWB4509 □□	60"	28"	28 1/4"	88	\$220.15
RWB4513 □□	60"	34"	28 1/4"	102	\$243.65
RWB4517 □□	60"	28"	32 1/4"	90	\$224.75
RWB4521 □□	60"	34"	32 1/4"	103	\$248.05
RWB4525 □□	72"	28"	28 1/4"	101	\$242.45
RWB4529 □□	72"	34"	28 1/4"	117	\$269.40
RWB4533 □□	72"	28"	32 1/4"	103	\$247.05
RWB4537 □□	72"	34"	32 1/4"	119	\$273.80

CONFIGURATION AND ACCESSORIES

Risers, bottom shelves, drawer with sliding tray, drawer, mounting angle, drawer lock with spring bolt, dead bolt, or master key are available.

Contact a technical representative at 202 305-3707 or 859 225-4824 for assistance.

20



configuration A



configuration B



configuration C

WORK BENCH CONFIGURATION B

Units include legs, steel top, stringer, shelf, one drawer, and back/end stops.

Stock No.	W	D	H	Weight (LBS)	Price
RWB4605 □□	60"	28"	28 1/4"	133	\$403.15
RWB4609 □□	60"	34"	28 1/4"	148	\$432.90
RWB4613 □□	60"	28"	32 1/4"	134	\$407.75
RWB4617 □□	60"	34"	32 1/4"	152	\$441.65
RWB4621 □□	72"	28"	28 1/4"	150	\$430.95
RWB4625 □□	72"	34"	28 1/4"	167	\$465.20
RWB4629 □□	72"	28"	32 1/4"	151	\$435.55
RWB4633 □□	72"	34"	32 1/4"	168	\$469.60

* Workbenches are available in gray only, color code 29.

WORK BENCH CONFIGURATION C

Units include legs, steel top, stringer, shelf, two drawers, back/end stops, and riser.

Stock No.	W	D	H	Weight (LBS)	Price
RWB4701 □□	60"	28"	28 1/4"	174	\$576.45
RWB4705 □□	60"	34"	28 1/4"	189	\$607.00
RWB4709 □□	60"	28"	32 1/4"	175	\$581.05
RWB4713 □□	60"	34"	32 1/4"	191	\$611.80
RWB4717 □□	72"	28"	28 1/4"	193	\$613.15
RWB4721 □□	72"	28"	28 1/4"	211	\$648.20
RWB4725 □□	72"	28"	32 1/4"	195	\$617.75
RWB4729 □□	72"	34"	32 1/4"	213	\$652.60

TABLES

UNICOR brings you tables that are tops in form and function. A choice of laminate tops are available to beautifully complement any surrounding. Quality craftsmanship and attention to detail set these tables apart from the crowd. Ample surface space lets you work or play in comfort. With UNICOR, you not only get an excellent product and value, but you get a company that caters to your needs. Table base color is black; other colors available by special order.

Logo Table

Logo tables are unique tables that can display your organization's seal embossed on a 24" or 30" diameter wooden top. Be proud and display your organization's seal. The standard seals are: Navy, Marine, Army, BOP, Coast Guard, and Air Force. Seals can be custom made per your specifications at an additional first-run cost.



logo table

Contemporary Table

This functional and stylish table comes with a walnut laminate top and a center drawer. The legs have a satin chrome finish and adjustable glide feet. Drawer size: 23³/₄"W x 2"D x 24¹/₂"L

CONTEMPORARY TABLE

Stock No.	Dim. (W/L/H)	Price
7110001130507	30" x 60" x 29", Black	\$230.00
7110001130509	30" x 60" x 29", Parchment	\$230.00



contemporary table

LOGO TABLES-ROUND

Stock No.	Dim. (Diameter)	Price
LTBR24 <input type="checkbox"/>	24"	\$395.00
LTBR30 <input type="checkbox"/>	30"	\$415.00
LTBR36 <input type="checkbox"/>	36"	\$425.00
LTBR42 <input type="checkbox"/>	42"	\$435.00
LTBR48 <input type="checkbox"/>	48"	\$450.00

*Add the one letter color code to the end of your table selection. The base is standard black.

AVAILABLE GOVERNMENT LOGOS*

Marine seal, Army seal, Coast Guard seal, Air Force seal, Bureau of Prisons seal, and the Navy seal

- M - Marine
- A - Army
- C - Coast Guard
- N - Navy
- F - Air Force
- B - Bureau of Prisons

* If we do not have the logo, there is a one-time \$300 set-up charge to add new logos.

* Minimum order of six.

Game Table (not shown)

36" x 36" checkerboard top, black base with 2 fixed fiberglass seats. Seats are available in either disc or high-back, your choice of gray, black, or sand (see café tables on page 22).

GAME TABLE

Stock No.	Dim. (W/D)	Price
GT3636 <input type="checkbox"/> <input type="checkbox"/>	36" x 36"	\$369.00

WORK BENCHES / TABLES

Café Tables

CAFÉ TABLES

UNICOR makes these table and seating combinations with durability, flexibility, and beauty in mind. They're constructed with sturdy metal frames in your choice of bolt-down legs for permanent attachment to the floor or adjustable glide models, featuring chrome-plated glides with nylon pads for smooth nonscratch movement. Tabletops are made of thick, high-grade particle board permanently bonded with high-pressure laminate. The fiberglass seating is designed for years of easy-care maintenance and is available in your choice of flat disc style or molded highback shells. The choice is yours: You decide the table size, leg style, and chair style you prefer. Then choose the color metal frame you want, as well as the tabletop laminate shade. The wide range of seating colors gives you the opportunity either to brighten dining and lounge areas with vivid colors or create a relaxed atmosphere with neutrals.



four-person high-back café table

22

HOW TO BUILD A MODEL NUMBER FOR CAFÉ TABLES:

A — Select a fiberglass seat color. **B** — Select a laminate finish.

<div style="background-color: #cccccc; padding: 5px; width: 40px; height: 40px; margin: 0 auto;"></div> <p>Gray - G</p> <p style="text-align: center;">G</p>	<div style="background-color: #000000; padding: 5px; width: 40px; height: 40px; margin: 0 auto;"></div> <p>Black - B</p> <p style="text-align: center;">B</p>	<div style="background-color: #d4c08c; padding: 5px; width: 40px; height: 40px; margin: 0 auto;"></div> <p>Sand - S</p> <p style="text-align: center;">S</p>	<div style="background-color: #e0c090; padding: 5px; width: 40px; height: 40px; margin: 0 auto;"></div> <p>Lt. Oak - L</p> <p style="text-align: center;">L</p>	<div style="background-color: #cccccc; padding: 5px; width: 40px; height: 40px; margin: 0 auto;"></div> <p>Gray - G</p> <p style="text-align: center;">G</p>
--	---	--	---	--



two-person high-back café table

CAFÉ TABLES

TWO-SEAT ADJUSTABLE GLIDE MODEL

Stock No.	Description	Dim. (W/D)	Price
FS3036GD2 <input type="checkbox"/>	Café Table, Disk Seat	30" X 36"	\$239.00
FS3036GH2 <input type="checkbox"/>	Café Table, High Back Seat	30" X 36"	\$299.00



CAFÉ TABLES

TWO-SEAT BOLT-DOWN MODEL

Stock No.	Description	Dim. (W/D)	Price
FS3036BD2 <input type="checkbox"/>	Café Table, Disk Seat	30" X 36"	\$229.00
FS3036BH2 <input type="checkbox"/>	Café Table, High Back Seat	30" X 36"	\$289.00



CAFÉ TABLES

FOUR-SEAT ADJUSTABLE GLIDE MODEL

Stock No.	Description	Dim. (W/D)	Price
FS4836GD4 <input type="checkbox"/> <input type="checkbox"/>	Café Table, Disk Seat	48" X 36"	\$279.00
FS4836GH4 <input type="checkbox"/> <input type="checkbox"/>	Café Table, High Back Seat	48" X 36"	\$369.00
FS3636GD4 <input type="checkbox"/> <input type="checkbox"/>	Café Table, Disk Seat	36" X 36"	\$279.00
FS3636GH4 <input type="checkbox"/> <input type="checkbox"/>	Café Table, High Back Seat	36" X 36"	\$379.00

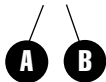

CAFÉ TABLES

FOUR-SEAT BOLT-DOWN MODEL

Stock No.	Description	Dim. (W/D)	Price
FS4836BD4 <input type="checkbox"/> <input type="checkbox"/>	Café Table, Disk Seat	48" X 36"	\$269.00
FS4836BH4 <input type="checkbox"/> <input type="checkbox"/>	Café Table, High Back Seat	48" X 36"	\$359.00
FS3636BD4 <input type="checkbox"/> <input type="checkbox"/>	Café Table, Disk Seat	36" X 36"	\$269.00
FS3636BH4 <input type="checkbox"/> <input type="checkbox"/>	Café Table, High Back Seat	36" X 36"	\$359.00

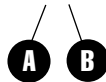

café table with disk seats

CAFÉ TABLES (not shown)

SIX-SEAT BOLT-DOWN MODEL

Stock No.	Description	Dim. (W/D)	Price
FS7236BD6 <input type="checkbox"/> <input type="checkbox"/>	Café Table, Disk Seat	72" X 36"	\$319.00

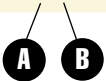

CAFÉ TABLES (not shown)

SIX-SEAT GLIDE MODEL

Stock No.	Description	Dim. (W/D)	Price
FS7236GD6 <input type="checkbox"/> <input type="checkbox"/>	Café Table, Disk Seat	72" X 36"	\$329.00

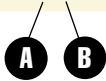

SHELVING

Steel Shelving



24

How To Select Steel Shelving

1

Select from four styles and types:

- Nut and Bolt
- Clip-Type
- Wide Span
- Speciality

Each style offers a wide range of applications with many accessory items to maximize your storage requirements.

2

Choose a size:

UNICOR shelving is available in a wide range of depths, widths, and heights.

Internet Orders:

www.unicor.gov

Whether you choose our ready-to-assemble shelving packages, component parts for custom shelving, or the flexible clip-type shelving, UNICOR has the shelving you need. You'll find our merchandise strong and durable.

It's as easy as 1, 2, 3, 4 to specify your shelving. Refer to the following page for a graphic pictorial of each step.



3

Determine a configuration:

UNICOR accepts customer-supplied layout and designs or offers assistance based on your available floor space. UNICOR staff will assist you in the selection of the style that best fits your requirements and will provide complete design and layout services of your storage areas, if requested.

Call 202 305-3707, 405 262-4875 ext. 391, or 859 225-4824 for assistance.

4

Determine load-bearing capacity:

UNICOR shelving is available in three classes of strength. Each class has a different weight capacity.

SHELVING

Steel Shelving

1 SELECT A STYLE/TYPE

- Open shelving with detachable bolt fasteners
- Open shelving with clip-type fasteners
- Closed shelving with detachable bolt fasteners
- Closed shelving with clip-type fasteners
- Ledge shelving
- Counter shelving
- Wire shelving

2 CHOOSE A SIZE

Widths	Depths
24"	12"
30"	15"
36"	18"
42"	24"
48"	30"
	36"

Standard sizes are found on page 36

Shelf Height	Number of Openings	Number of Shelves
75"	6	7
87"	7	8
99"	8	9
111"	9	10

Numerous additional sizes available up to 171"

3 DETERMINE A CONFIGURATION

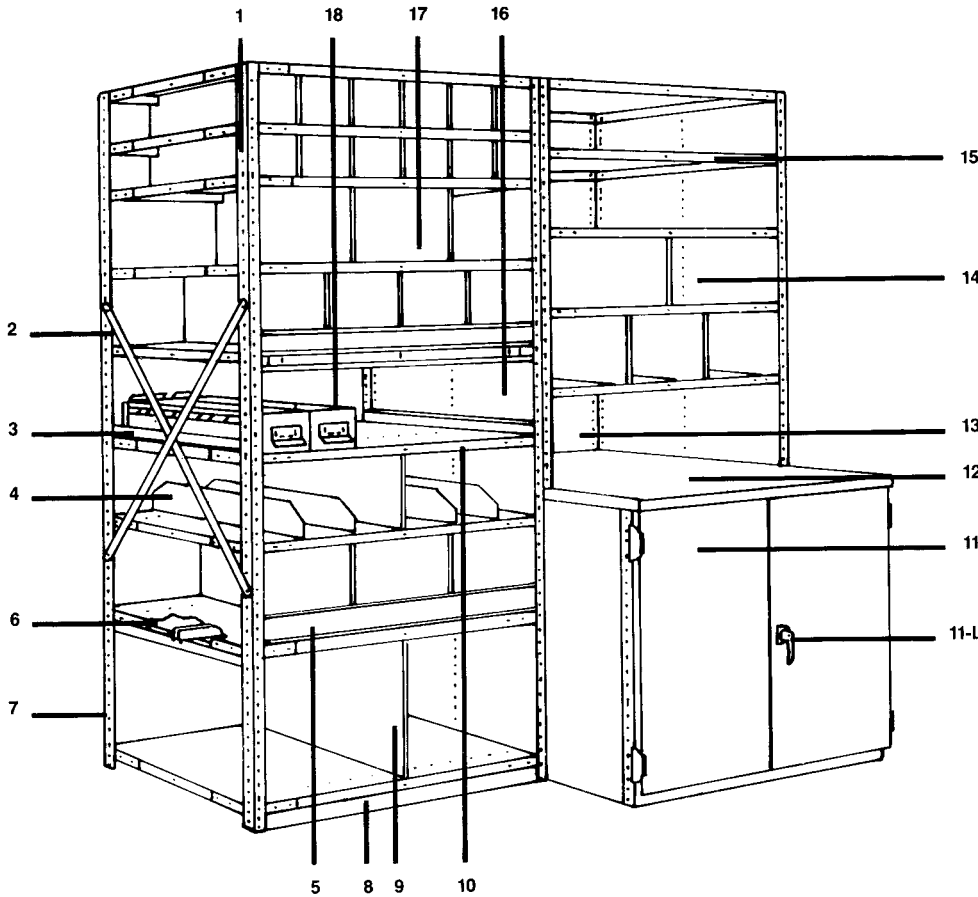

1. Angle-Sway Braces
2. Cross-Strap Braces
3. Flush Bars
4. Angle Bin Dividers
5. Bin Front
6. Shelf Reinforcing Side and Center Angles
7. Corner Post or Upright
8. Base Strip
9. Bin Dividers
10. Label Holders
11. Double Door
- 11-L. Handle Lock
12. Ledge Shelf
13. Back Panel
14. End Panel
15. Plain Shelf
16. Intermediate Partition
17. Bin Dividers
18. Storage Drawer



open shelving



closed shelving



counter shelving



ledge shelving

4 DETERMINE A LOAD-BEARING CAPACITY

Standard Shelf Sizes

LBS Per Shelf

Width	Depth	Class 1	Class 1A	Class 2	Class 3
24"	12"	700	1000	1200	2000
24"	15"	700	1000	1150	2000
24"	18"	700	900	1000	2200
24"	24"	700	900	1000	1700
24"	30"	700	800	900	1600
24"	36"	700	800	900	1500
30"	12"	600	900	1200	1800
30"	15"	600	900	1200	1750
30"	18"	600	800	1100	1700
30"	24"	600	800	1050	1650
30"	30"	600	750	1000	1600
30"	36"	550	650	950	1600
36"	12"	400	800	1000	1500
36"	15"	400	750	1100	1650
36"	18"	450	750	1000	1800
36"	24"	450	700	1000	1700
36"	30"	450	700	860	1500
36"	36"	450	500	700	1300
42"	12"	300	350	700	850
42"	15"	300	350	600	900
42"	18"	350	400	525	1300
42"	24"	300	350	700	1200
42"	30"	300	350	650	1050
42"	36"	300	350	650	1050
48"	12"	300	320	400	560
48"	15"	300	320	400	750
48"	18"	300	320	400	650
48"	24"	300	400	520	1000
48"	30"	300	400	400	1150
48"	36"	250	390	420	1000

SHELVING

Steel Shelving Specifications General Information

All shelving complies with GSA requirements and Federal specifications.

Uprights (standard)

All uprights (corner posts) are made from structural steel angles 1" x 1³/₄" x 1/8" 10-gauge thick. Uprights have 5/16" diam. holes on 1" centers that span the entire height of the post for shelf spacing and adjustment. Cross-strap braces, angle-sway braces, and partitions attach to the upright. Four uprights are required for each unit; heights available from 36" to 195". Bolts, nuts, and braces do not obstruct the full adjustability of the shelves.

End Panel/Partition

Made from 22-gauge steel (standard) used at ends of shelving units and at intermediate joints in rack formations. Mounting holes are spaced on 1" centers to match mating holes in post.

Back Panel/Partition

Made from 22-gauge steel (standard) used at back of shelves in single-faced units and between double-faced units. Mounting holes are spaced on centers to match mating holes in post, with an additional vertical row of holes in the center for attachment to shelves.



28

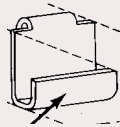

Beaded Uprights (clip-type) for Lighter Loads

Made from 14-gauge steel. Comes with rectangular mounting holes the entire length of the post to receive shelf clips, permitting adjustment of shelf height in 1 1/2" increments. Additional holes are provided as may be required for attachment of all other component parts of shelving units whenever such components attach to posts (shown on page 46).

Angle-Sway Braces

Made from 13-gauge steel. Each angle leg is 4¹⁵/₁₆" long x 1³/₁₆" wide. The angle sway brace reinforces open type shelving and provides clear, unobstructed shelf openings. Use with heavy or extra heavy loads on standard shelving.

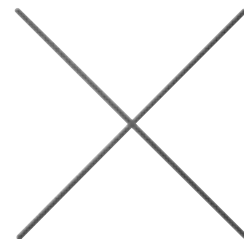

Clips

Used on clip-type shelving; clips are one-piece construction and are easily positioned without any tools. One clip is hooked into each corner post, and first one side and then the other side of the flanged shelf is tilted into place.

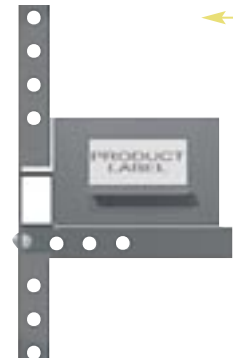

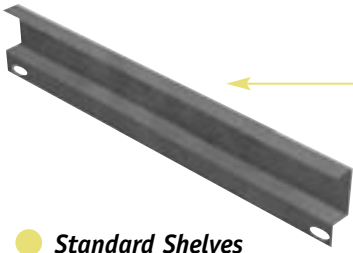

Flush Bars/Storage Drawer Guides

Made from 22-gauge steel, used at shelf ends (2 per shelf) to prevent storage drawers, boxes, etc. from catching behind uprights.

Standard Shelves

Shelves come in one of four categories: Class 1, 1A, 2, and 3, depending on load requirements. Plain, Class 1 shelves are made from 18-gauge steel flanged down on all sides with $\frac{13}{16}$ " holes at sides and ends of assembly to uprights, and $\frac{5}{16}$ " holes spaced 2" apart on the surface for attachment of optional bin dividers. Class 1 shelves have no reinforcement angles. Reinforcement angles sold separately. See shelf load capacity on page 25.

Flanged Bin Dividers

Made from 20-gauge steel, with matching holes for top and bottom flanges for securing to shelf bin divider holes with bolts or self-inserting clips. Dividers attach to the top and bottom of the shelf for heavy-duty use. For heights 6" through 10", front edges are folded back flat. Heights 12" to 24" have the front edge formed into a bead. All rear edges are flanged $\frac{1}{2}$ " at right angles. Not for use with Class 3 shelving.



Drawer Insert Units

For use in 36" wide shelving units with depths of either 12" or 18". Drawers have two dividers each, adjustable on 1" centers, and have provisions for label inserts $\frac{11}{32}$ " high. Extra dividers can be purchased separately. Drawers have stops to prevent falling when fully extended.

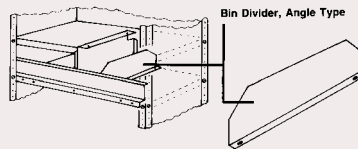
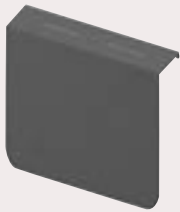

Cross-Strap Braces

Made from $\frac{1}{8}$ " thick steel strap $\frac{3}{4}$ " wide with $\frac{5}{16}$ " holes at each end for bolting to post. Units with heights of 8'3" and higher should use two pairs on each side and back. Cross-strap braces are intended for lighter loads only. For heavy or extra heavy loads, angle-sway braces are recommended.

Angle-Type Bin Divider

Made from 18-gauge steel, with matching holes in bottom flange for securing to shelf bin divider holes with bolts and self-inserting clips, for division of shelf openings into smaller compartments.

Label Holders

Used for shelves 24" to 48" wide and made from 22-gauge steel, 1" high with edges turned back to accommodate $\frac{15}{16}$ " label. Two holes at each end and one in center for fastening to matching holes in shelf face with self-inserting clips.

Bin Fronts

Made from 18-gauge steel, for use with closed shelving units to retain small articles on shelves. Has holes for securing to front of shelf and for attaching label holder.

Storage Drawer

Made from 20-gauge steel, with combined pull handle/label holders for $1\frac{1}{2}$ " x 3" cards. Each drawer has slots for dividers on 1" centers and stops to prevent drawers from falling when fully extended.

Base Strip or Closure

Made from 18-gauge steel (for standard units) and 22-gauge (for clip-type units) for closing the space between the bottom shelf and the floor.

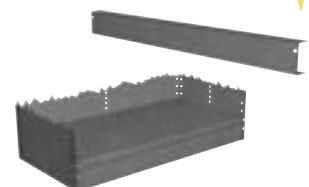

SHELVING

Open Steel Shelving Nut & Bolt

Quality Shelves

With UNICOR steel shelving components, you can easily construct custom storage configurations that make the best use of your space. A basic unit is self-standing and includes all shelves and corner posts using angle-sway braces. A rack of units combines two or more units side by side or back to back. Standard units have shelves spaced 12" apart on centers, adjustable on 1" centers throughout the height of the units. All components comply and exceed GSA and Federal Government requirements.

For special configurations and sizes not listed and installation/off-load needs, call 202 305-3707, 859 225-4824, or 405 262-4875 ext. 391.

30

OPEN STEEL SHELVING UNITS/NUT & BOLT

Stock No.	Weight (LBS)	Initial/Additional	W	D	H	Class	Price
SHV0001	82	I	24"	12"	75"	1A	\$81.00
SHV0002	77	A	24"	12"	75"	1A	\$68.00
SHV0003	92	I	24"	12"	75"	2	\$85.00
SHV0004	87	A	24"	12"	75"	2	\$75.00
SHV0005	100	I	24"	12"	75"	3	\$89.00
SHV0006	95	A	24"	12"	75"	3	\$77.00
SHV0007	94	I	24"	12"	87"	1A	\$89.00
SHV0008	88	A	24"	12"	87"	1A	\$75.00
SHV0009	105	I	24"	12"	87"	2	\$98.00
SHV0010	99	A	24"	12"	87"	2	\$83.00



Stock No.	Weight (LBS)	Initial/Additional	W	D	H	Class	Price
SHV0011	115	I	24"	12"	87"	3	\$100.00
SHV0012	109	A	24"	12"	87"	3	\$86.00
SHV0013	106	I	24"	12"	99"	1A	\$99.00
SHV0014	99	A	24"	12"	99"	1A	\$83.00
SHV0015	114	I	24"	12"	99"	2	\$108.00
SHV0016	112	A	24"	12"	99"	2	\$91.00
SHV0017	130	I	24"	12"	99"	3	\$110.00
SHV0018	123	A	24"	12"	99"	3	\$95.00
SHV0019	118	I	24"	12"	111"	1A	\$110.00
SHV0020	110	A	24"	12"	111"	1A	\$92.00
SHV0021	132	I	24"	12"	111"	2	\$120.00
SHV0022	124	A	24"	12"	111"	2	\$101.00
SHV0023	144	I	24"	12"	111"	3	\$123.00
SHV0024	136	A	24"	12"	111"	3	\$105.00
SHV0025	93	I	24"	15"	75"	1A	\$85.00

Stock No.	Weight (LBS)	Initial/Additional	W	D	H	Class	Price
SHV0026	85	A	24"	15"	75"	1A	\$71.00
SHV0027	100	I	24"	15"	75"	2	\$93.00
SHV0028	95	A	24"	15"	75"	2	\$79.00
SHV0029	108	I	24"	15"	75"	3	\$95.00
SHV0030	103	A	24"	15"	75"	3	\$82.00
SHV0031	103	I	24"	15"	87"	1A	\$95.00
SHV0032	97	A	24"	15"	87"	1A	\$81.00
SHV0033	115	I	24"	15"	87"	2	\$103.00
SHV0034	109	A	24"	15"	87"	2	\$88.00
SHV0035	124	I	24"	15"	87"	3	\$105.00
SHV0036	118	A	24"	15"	87"	3	\$92.00
SHV0037	117	I	24"	15"	99"	1A	\$105.00
SHV0038	110	A	24"	15"	99"	1A	\$87.00
SHV0039	130	I	24"	15"	99"	2	\$114.00

Stock No.	Weight (LBS)	Initial/Additional	W	D	H	Class	Price
SHV0056	107	A	24"	18"	87"	1A	\$83.00
SHV0057	124	I	24"	18"	87"	2	\$106.00
SHV0058	118	A	24"	18"	87"	2	\$92.00
SHV0059	183	I	24"	18"	87"	3	\$148.00
SHV0060	177	A	24"	18"	87"	3	\$131.00
SHV0061	128	I	24"	18"	99"	1A	\$108.00
SHV0062	121	A	24"	18"	99"	1A	\$91.00
SHV0063	140	I	24"	18"	99"	2	\$117.00
SHV0064	133	A	24"	18"	99"	2	\$100.00
SHV0065	206	I	24"	18"	99"	3	\$161.00
SHV0066	199	A	24"	18"	99"	3	\$145.00
SHV0067	142	I	24"	18"	111"	1A	\$119.00
SHV0068	134	A	24"	18"	111"	1A	\$102.00
SHV0069	156	I	24"	18"	111"	2	\$130.00

1 — Select a finish color.

2 — Place 2-digit color code at end of stock no.

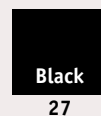
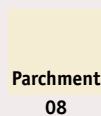

Additional colors may be available. Please call 202 305-3707 or 859 225-4824 for more information.

Stock No.	Weight (LBS)	Initial/Additional	W	D	H	Class	Price
SHV0040	123	A	24"	15"	99"	2	\$97.00
SHV0041	140	I	24"	15"	99"	3	\$117.00
SHV0042	133	A	24"	15"	99"	3	\$99.00
SHV0043	130	I	24"	15"	111"	1A	\$117.00
SHV0044	122	A	24"	15"	111"	1A	\$97.00
SHV0045	144	I	24"	15"	111"	2	\$126.00
SHV0046	136	A	24"	15"	111"	2	\$108.00
SHV0047	156	I	24"	15"	111"	3	\$132.00
SHV0048	148	A	24"	15"	111"	3	\$110.00
SHV0049	99	I	24"	18"	75"	1A	\$87.00
SHV0050	94	A	24"	18"	75"	1A	\$75.00
SHV0051	108	I	24"	18"	75"	2	\$95.00
SHV0052	103	A	24"	18"	75"	2	\$83.00
SHV0053	160	I	24"	18"	75"	3	\$130.00
SHV0054	155	A	24"	18"	75"	3	\$117.00
SHV0055	113	I	24"	18"	87"	1A	\$98.00

Stock No.	Weight (LBS)	Initial/Additional	W	D	H	Class	Price
SHV0070	148	A	24"	18"	111"	2	\$111.00
SHV0071	230	I	24"	18"	111"	3	\$179.00
SHV0072	222	A	24"	18"	111"	3	\$161.00
SHV0073	115	I	24"	24"	75"	1A	\$97.00
SHV0074	110	A	24"	24"	75"	1A	\$83.00
SHV0075	125	I	24"	24"	75"	2	\$105.00
SHV0076	120	A	24"	24"	75"	2	\$92.00
SHV0077	183	I	24"	24"	75"	3	\$143.00
SHV0078	178	A	24"	24"	75"	3	\$130.00
SHV0079	132	I	24"	24"	87"	1A	\$108.00
SHV0080	126	A	24"	24"	87"	1A	\$94.00
SHV0081	143	I	24"	24"	87"	2	\$117.00
SHV0082	137	A	24"	24"	87"	2	\$100.00
SHV0083	210	I	24"	24"	87"	3	\$161.00
SHV0084	204	A	24"	24"	87"	3	\$145.00
SHV0085	149	I	24"	24"	99"	1A	\$119.00

SHELVING

Open Steel Shelving Nut & Bolt

OPEN STEEL SHELVING UNITS/NUT & BOLT

Stock No.	Weight (LBS)	Initial/Additional	W	D	H	Class	Price
SHV0086	142	A	24"	24"	99"	1A	\$102.00
SHV0087	162	I	24"	24"	99"	2	\$129.00
SHV0088	155	A	24"	24"	99"	2	\$112.00
SHV0089	237	I	24"	24"	99"	3	\$178.00
SHV0090	230	A	24"	24"	99"	3	\$161.00
SHV0091	166	I	24"	24"	111"	1A	\$132.00
SHV0092	158	A	24"	24"	111"	1A	\$114.00
SHV0093	182	I	24"	24"	111"	2	\$143.00
SHV0094	172	A	24"	24"	111"	2	\$124.00
SHV0095	264	I	24"	24"	111"	3	\$198.00
SHV0096	256	A	24"	24"	111"	3	\$180.00

Stock No.	Weight (LBS)	Initial/Additional	W	D	H	Class	Price
SHV0112	150	A	36"	12"	99"	2	\$106.00
SHV0113	175	I	36"	12"	99"	3	\$131.00
SHV0114	168	A	36"	12"	99"	3	\$114.00
SHV0115	153	I	36"	12"	111"	1A	\$123.00
SHV0116	146	A	36"	12"	111"	1A	\$105.00
SHV0117	175	I	36"	12"	111"	2	\$137.00
SHV0118	167	A	36"	12"	111"	2	\$118.00
SHV0119	195	I	36"	12"	111"	3	\$145.00
SHV0120	187	A	36"	12"	111"	3	\$128.00
SHV0121	118	I	36"	15"	75"	1A	\$97.00
SHV0122	113	A	36"	15"	75"	1A	\$84.00



nut & bolt



open steel shelving

Stock No.	Weight (LBS)	Initial/Additional	W	D	H	Class	Price
SHV0097	106	I	36"	12"	75"	1A	\$89.00
SHV0098	101	A	36"	12"	75"	1A	\$77.00
SHV0099	122	I	36"	12"	75"	2	\$99.00
SHV0100	117	A	36"	12"	75"	2	\$86.00
SHV0101	136	I	36"	12"	75"	3	\$106.00
SHV0102	131	A	36"	12"	75"	3	\$94.00
SHV0103	122	I	36"	12"	87"	1A	\$100.00
SHV0104	116	A	36"	12"	87"	1A	\$86.00
SHV0105	139	I	36"	12"	87"	2	\$111.00
SHV0106	133	A	36"	12"	87"	2	\$96.00
SHV0107	155	I	36"	12"	87"	3	\$119.00
SHV0108	149	A	36"	12"	87"	3	\$104.00
SHV0109	138	I	36"	12"	99"	1A	\$110.00
SHV0110	131	A	36"	12"	99"	1A	\$95.00
SHV0111	157	I	36"	12"	99"	2	\$122.00

Stock No.	Weight (LBS)	Initial/Additional	W	D	H	Class	Price
SHV0123	133	I	36"	15"	75"	2	\$107.00
SHV0124	128	A	36"	15"	75"	2	\$94.00
SHV0125	147	I	36"	15"	75"	3	\$112.00
SHV0126	142	A	36"	15"	75"	3	\$99.00
SHV0127	135	I	36"	15"	87"	1A	\$108.00
SHV0128	129	A	36"	15"	87"	1A	\$94.00
SHV0129	152	I	36"	15"	87"	2	\$119.00
SHV0130	146	A	36"	15"	87"	2	\$104.00
SHV0131	168	I	36"	15"	87"	3	\$126.00
SHV0132	162	A	36"	15"	87"	3	\$112.00
SHV0133	152	I	36"	15"	99"	1A	\$119.00
SHV0134	146	A	36"	15"	99"	1A	\$101.00
SHV0135	172	I	36"	15"	99"	2	\$131.00
SHV0136	165	A	36"	15"	99"	2	\$114.00
SHV0137	190	I	36"	15"	99"	3	\$140.00

Stock No.	Weight (LBS)	Initial/Additional	W	D	H	Class	Price
SHV0138	183	A	36"	15"	99"	3	\$133.00
SHV0139	169	I	36"	15"	111"	1A	\$132.00
SHV0140	161	A	36"	15"	111"	1A	\$114.00
SHV0141	191	I	36"	15"	111"	2	\$143.00
SHV0142	183	A	36"	15"	111"	2	\$128.00
SHV0143	211	I	36"	15"	111"	3	\$159.00
SHV0144	203	A	36"	15"	111"	3	\$137.00
SHV0145	129	I	36"	18"	75"	1A	\$104.00
SHV0146	124	A	36"	18"	75"	1A	\$89.00
SHV0147	145	I	36"	18"	75"	2	\$111.00
SHV0148	140	A	36"	18"	75"	2	\$98.00
SHV0149	212	I	36"	18"	75"	3	\$159.00
SHV0150	207	A	36"	18"	75"	3	\$142.00
SHV0151	147	I	36"	18"	87"	1A	\$116.00

Stock No.	Weight (LBS)	Initial/Additional	W	D	H	Class	Price
SHV0166	199	A	36"	18"	111"	2	\$135.00
SHV0167	305	I	36"	18"	111"	3	\$216.00
SHV0168	297	A	36"	18"	111"	3	\$197.00
SHV0169	151	I	36"	24"	75"	1A	\$112.00
SHV0170	146	A	36"	24"	75"	1A	\$99.00
SHV0171	167	I	36"	24"	75"	2	\$122.00
SHV0172	162	A	36"	24"	75"	2	\$109.00
SHV0173	242	I	36"	24"	75"	3	\$170.00
SHV0174	237	A	36"	24"	75"	3	\$156.00
SHV0175	173	I	36"	24"	87"	1A	\$126.00
SHV0176	167	A	36"	24"	87"	1A	\$111.00
SHV0177	191	I	36"	24"	87"	2	\$137.00
SHV0178	185	A	36"	24"	87"	2	\$122.00
SHV0179	276	I	36"	24"	87"	3	\$192.00

1 — Select a finish color.

2 — Place 2-digit color code at end of stock no.

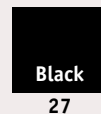
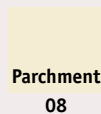

Additional colors may be available. Please call 202 305-3707 or 859 225-4824 for more information.

Stock No.	Weight (LBS)	Initial/Additional	W	D	H	Class	Price
SHV0152	141	A	36"	18"	87"	1A	\$99.00
SHV0153	165	I	36"	18"	87"	2	\$124.00
SHV0154	159	A	36"	18"	87"	2	\$110.00
SHV0155	243	I	36"	18"	87"	3	\$174.00
SHV0156	237	A	36"	18"	87"	3	\$160.00
SHV0157	166	I	36"	18"	99"	1A	\$128.00
SHV0158	159	A	36"	18"	99"	1A	\$110.00
SHV0159	186	I	36"	18"	99"	2	\$138.00
SHV0160	179	A	36"	18"	99"	2	\$122.00
SHV0161	274	I	36"	18"	99"	3	\$194.00
SHV0162	267	A	36"	18"	99"	3	\$178.00
SHV0163	185	I	36"	18"	111"	1A	\$141.00
SHV0164	177	A	36"	18"	111"	1A	\$122.00
SHV0165	207	I	36"	18"	111"	2	\$154.00

Stock No.	Weight (LBS)	Initial/Additional	W	D	H	Class	Price
SHV0180	270	A	36"	24"	87"	3	\$176.00
SHV0181	195	I	36"	24"	99"	1A	\$141.00
SHV0182	188	A	36"	24"	99"	1A	\$123.00
SHV0183	215	I	36"	24"	99"	2	\$152.00
SHV0184	209	A	36"	24"	99"	2	\$136.00
SHV0185	312	I	36"	24"	99"	3	\$214.00
SHV0186	305	A	36"	24"	99"	3	\$196.00
SHV0187	217	I	36"	24"	111"	1A	\$156.00
SHV0188	209	A	36"	24"	111"	1A	\$136.00
SHV0189	239	I	36"	24"	111"	2	\$168.00
SHV0190	231	A	36"	24"	111"	2	\$150.00
SHV0191	347	I	36"	24"	111"	3	\$238.00
SHV0192	339	A	36"	24"	111"	3	\$218.00

SHELVING

Closed Steel Shelving Nut & Bolt

CLOSED STEEL SHELVING UNITS/NUT & BOLT

Stock No.	Weight (LBS)	Initial/Additional	W	D	H	Class	Price
SHV0301	100	I	24"	12"	75"	1A	\$84.00
SHV0302	93	A	24"	12"	75"	1A	\$77.00
SHV0303	110	I	24"	12"	75"	2	\$92.00
SHV0304	103	A	24"	12"	75"	2	\$85.00
SHV0305	118	I	24"	12"	75"	3	\$94.00
SHV0306	111	A	24"	12"	75"	3	\$87.00
SHV0307	116	I	24"	12"	87"	1A	\$94.00
SHV0308	107	A	24"	12"	87"	1A	\$86.00
SHV0309	128	I	24"	12"	87"	2	\$100.00
SHV0310	119	A	24"	12"	87"	2	\$95.00
SHV0311	137	I	24"	12"	87"	3	\$104.00

Stock No.	Weight (LBS)	Initial/Additional	W	D	H	Class	Price
SHV0328	113	A	24"	15"	75"	2	\$89.00
SHV0329	130	I	24"	15"	75"	3	\$100.00
SHV0330	121	A	24"	15"	75"	3	\$92.00
SHV0331	130	I	24"	15"	87"	1A	\$112.00
SHV0332	119	A	24"	15"	87"	1A	\$92.00
SHV0333	141	I	24"	15"	87"	2	\$109.00
SHV0334	130	A	24"	15"	87"	2	\$100.00
SHV0335	151	I	24"	15"	87"	3	\$111.00
SHV0336	140	A	24"	15"	87"	3	\$103.00
SHV0337	148	I	24"	15"	99"	1A	\$112.00
SHV0338	136	A	24"	15"	99"	1A	\$104.00

34

1 — Select a finish color.

2 — Place 2-digit color code at end of stock no.

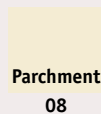

Additional colors may be available. Please call 202 305-3707 or 859 225-4824 for more information.

Stock No.	Weight (LBS)	Initial/Additional	W	D	H	Class	Price
SHV0312	128	A	24"	12"	87"	3	\$97.00
SHV0313	132	I	24"	12"	99"	1A	\$104.00
SHV0314	122	A	24"	12"	99"	1A	\$97.00
SHV0315	146	I	24"	12"	99"	2	\$112.00
SHV0316	135	A	24"	12"	99"	2	\$105.00
SHV0317	154	I	24"	12"	99"	3	\$116.00
SHV0318	146	A	24"	12"	99"	3	\$108.00
SHV0319	149	I	24"	12"	111"	1A	\$119.00
SHV0320	138	A	24"	12"	111"	1A	\$109.00
SHV0321	163	I	24"	12"	111"	2	\$129.00
SHV0322	152	A	24"	12"	111"	2	\$119.00
SHV0323	175	I	24"	12"	111"	3	\$131.00
SHV0324	164	A	24"	12"	111"	3	\$123.00
SHV0325	112	I	24"	15"	75"	1A	\$92.00
SHV0326	103	A	24"	15"	75"	1A	\$83.00
SHV0327	122	I	24"	15"	75"	2	\$98.00

Stock No.	Weight (LBS)	Initial/Additional	W	D	H	Class	Price
SHV0339	160	I	24"	15"	99"	2	\$121.00
SHV0340	148	A	24"	15"	99"	2	\$111.00
SHV0341	171	I	24"	15"	99"	3	\$123.00
SHV0342	159	A	24"	15"	99"	3	\$116.00
SHV0343	166	I	24"	15"	111"	1A	\$138.00
SHV0344	152	A	24"	15"	111"	1A	\$117.00
SHV0345	180	I	24"	15"	111"	2	\$137.00
SHV0346	166	A	24"	15"	111"	2	\$128.00
SHV0347	192	I	24"	15"	111"	3	\$151.00
SHV0348	178	A	24"	15"	111"	3	\$140.00
SHV0349	124	I	24"	18"	75"	1A	\$96.00
SHV0350	113	A	24"	18"	75"	1A	\$91.00
SHV0351	134	I	24"	18"	75"	2	\$103.00
SHV0352	123	A	24"	18"	75"	2	\$94.00
SHV0353	185	I	24"	18"	75"	3	\$136.00

Closed Steel Shelving

Closed shelving provides a more finished appearance and reduces the risk of items slipping through open sides. Shelving consists of one initial unit plus one or more additional units. The additional units are identical to the initial unit but have no partition or end panel. Top and bottom shelves are fixed and other shelves are available on 1" centers. Using components listed on pages 36-49, you can build UNICOR shelving units into many configurations, and use accessories described on the next few pages to increase functionality. Detailed component listings are also available from our Customer Service Center at 800 827-3168, 202 305-3707, 859 225-4824, or 405 262-4875 ext. 391.



closed steel shelving, initial unit and one additional unit

Stock No.	Weight (LBS)	Initial/Additional	W	D	H	Class	Price
SHV0354	174	A	24"	18"	75"	3	\$129.00
SHV0355	144	I	24"	18"	87"	1A	\$106.00
SHV0356	131	A	24"	18"	87"	1A	\$97.00
SHV0357	155	I	24"	18"	87"	2	\$113.00
SHV0358	142	A	24"	18"	87"	2	\$105.00
SHV0359	214	I	24"	18"	87"	3	\$154.00
SHV0360	201	A	24"	18"	87"	3	\$144.00
SHV0361	164	I	24"	18"	99"	1A	\$118.00
SHV0362	149	A	24"	18"	99"	1A	\$108.00
SHV0363	176	I	24"	18"	99"	2	\$121.00
SHV0364	161	A	24"	18"	99"	2	\$117.00
SHV0365	242	I	24"	18"	99"	3	\$171.00
SHV0366	227	A	24"	18"	99"	3	\$161.00
SHV0367	183	I	24"	18"	111"	1A	\$136.00

Stock No.	Weight (LBS)	Initial/Additional	W	D	H	Class	Price
SHV0368	166	A	24"	18"	111"	1A	\$122.00
SHV0369	197	I	24"	18"	111"	2	\$178.00
SHV0370	180	A	24"	18"	111"	2	\$133.00
SHV0371	271	I	24"	18"	111"	3	\$195.00
SHV0372	254	A	24"	18"	111"	3	\$183.00
SHV0373	150	I	24"	24"	75"	1A	\$110.00
SHV0374	135	A	24"	24"	75"	1A	\$98.00
SHV0375	160	I	24"	24"	75"	2	\$118.00
SHV0376	145	A	24"	24"	75"	2	\$106.00
SHV0377	218	I	24"	24"	75"	3	\$156.00
SHV0378	203	A	24"	24"	75"	3	\$144.00
SHV0379	176	I	24"	24"	87"	1A	\$121.00
SHV0380	156	A	24"	24"	87"	1A	\$109.00
SHV0381	185	I	24"	24"	87"	2	\$129.00

SHELVING

Closed Steel Shelving Nut & Bolt

CLOSED STEEL SHELVING UNITS/NUT & BOLT

Stock No.	Weight (LBS)	Initial/Additional	W	D	H	Class	Price
SHV0382	167	A	24"	24"	87"	2	\$118.00
SHV0383	251	I	24"	24"	87"	3	\$173.00
SHV0384	233	A	24"	24"	87"	3	\$161.00
SHV0385	197	I	24"	24"	99"	1A	\$135.00
SHV0386	177	A	24"	24"	99"	1A	\$121.00
SHV0387	210	I	24"	24"	99"	2	\$144.00
SHV0388	190	A	24"	24"	99"	2	\$131.00
SHV0389	284	I	24"	24"	99"	3	\$194.00
SHV0390	264	A	24"	24"	99"	3	\$181.00
SHV0391	220	I	24"	24"	111"	1A	\$155.00
SHV0392	197	A	24"	24"	111"	1A	\$138.00

Stock No.	Weight (LBS)	Initial/Additional	W	D	H	Class	Price
SHV0408	168	A	36"	12"	87"	3	\$120.00
SHV0409	174	I	36"	12"	99"	1A	\$120.00
SHV0410	164	A	36"	12"	99"	1A	\$112.00
SHV0411	194	I	36"	12"	99"	2	\$132.00
SHV0412	184	A	36"	12"	99"	2	\$124.00
SHV0413	212	I	36"	12"	99"	3	\$141.00
SHV0414	202	A	36"	12"	99"	3	\$132.00
SHV0415	195	I	36"	12"	111"	1A	\$144.00
SHV0416	184	A	36"	12"	111"	1A	\$130.00
SHV0417	217	I	36"	12"	111"	2	\$153.00
SHV0418	206	A	36"	12"	111"	2	\$143.00
SHV0419	237	I	36"	12"	111"	3	\$161.00

36

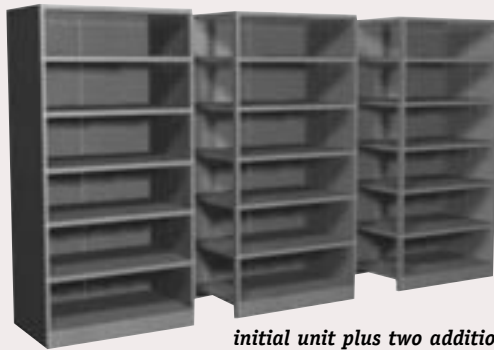

initial unit plus two additional units

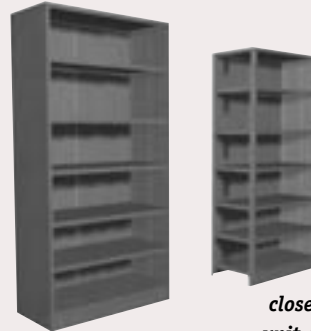

closed steel shelving, initial unit and one additional unit

Stock No.	Weight (LBS)	Initial/Additional	W	D	H	Class	Price
SHV0393	234	I	24"	24"	111"	2	\$165.00
SHV0394	211	A	24"	24"	111"	2	\$149.00
SHV0395	317	I	24"	24"	111"	3	\$220.00
SHV0396	294	A	24"	24"	111"	3	\$205.00
SHV0397	132	I	36"	12"	75"	1A	\$97.00
SHV0398	125	A	36"	12"	75"	1A	\$91.00
SHV0399	148	I	36"	12"	75"	2	\$107.00
SHV0400	141	A	36"	12"	75"	2	\$102.00
SHV0401	162	I	36"	12"	75"	3	\$112.00
SHV0402	155	A	36"	12"	75"	3	\$107.00
SHV0403	153	I	36"	12"	87"	1A	\$109.00
SHV0404	144	A	36"	12"	87"	1A	\$101.00
SHV0405	171	I	36"	12"	87"	2	\$119.00
SHV0406	162	A	36"	12"	87"	2	\$112.00
SHV0407	187	I	36"	12"	87"	3	\$128.00

Stock No.	Weight (LBS)	Initial/Additional	W	D	H	Class	Price
SHV0420	226	A	36"	12"	111"	3	\$153.00
SHV0421	146	I	36"	15"	75"	1A	\$107.00
SHV0422	138	A	36"	15"	75"	1A	\$98.00
SHV0423	162	I	36"	15"	75"	2	\$116.00
SHV0424	153	A	36"	15"	75"	2	\$108.00
SHV0425	176	I	36"	15"	75"	3	\$122.00
SHV0426	167	A	36"	15"	75"	3	\$113.00
SHV0427	170	I	36"	15"	87"	1A	\$119.00
SHV0428	159	A	36"	15"	87"	1A	\$110.00
SHV0429	188	I	36"	15"	87"	2	\$130.00
SHV0430	177	A	36"	15"	87"	2	\$121.00
SHV0431	204	I	36"	15"	87"	3	\$136.00
SHV0432	193	A	36"	15"	87"	3	\$129.00
SHV0433	193	I	36"	15"	99"	1A	\$132.00
SHV0434	181	A	36"	15"	99"	1A	\$122.00

Stock No.	Weight (LBS)	Initial/Additional	W	D	H	Class	Price
SHV0435	213	I	36"	15"	99"	2	\$143.00
SHV0436	201	A	36"	15"	99"	2	\$134.00
SHV0437	231	I	36"	15"	99"	3	\$152.00
SHV0438	219	A	36"	15"	99"	3	\$143.00
SHV0439	217	I	36"	15"	111"	1A	\$152.00
SHV0440	203	A	36"	15"	111"	1A	\$141.00
SHV0441	239	I	36"	15"	111"	2	\$165.00
SHV0442	225	A	36"	15"	111"	2	\$154.00
SHV0443	259	I	36"	15"	111"	3	\$173.00
SHV0444	245	A	36"	15"	111"	3	\$162.00
SHV0445	162	I	36"	18"	75"	1A	\$113.00
SHV0446	151	A	36"	18"	75"	1A	\$106.00
SHV0447	177	I	36"	18"	75"	2	\$123.00
SHV0448	166	A	36"	18"	75"	2	\$116.00
SHV0449	246	I	36"	18"	75"	3	\$167.00

Stock No.	Weight (LBS)	Initial/Additional	W	D	H	Class	Price
SHV0465	260	I	36"	18"	111"	2	\$177.00
SHV0466	243	A	36"	18"	111"	2	\$165.00
SHV0467	358	I	36"	18"	111"	3	\$230.00
SHV0468	341	A	36"	18"	111"	3	\$226.00
SHV0469	194	I	36"	24"	75"	1A	\$130.00
SHV0470	179	A	36"	24"	75"	1A	\$119.00
SHV0471	209	I	36"	24"	75"	2	\$141.00
SHV0472	194	A	36"	24"	75"	2	\$128.00
SHV0473	284	I	36"	24"	75"	3	\$186.00
SHV0474	269	A	36"	24"	75"	3	\$176.00
SHV0475	223	I	36"	24"	87"	1A	\$144.00
SHV0476	205	A	36"	24"	87"	1A	\$132.00
SHV0477	241	I	36"	24"	87"	2	\$155.00
SHV0478	223	A	36"	24"	87"	2	\$143.00
SHV0479	319	I	36"	24"	87"	3	\$209.00

1 — Select a finish color.

2 — Place 2-digit color code at end of stock no.

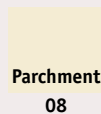

Additional colors may be available. Please call 202 305-3707 or 859 225-4824 for more information.

Stock No.	Weight (LBS)	Initial/Additional	W	D	H	Class	Price
SHV0450	235	A	36"	18"	75"	3	\$157.00
SHV0451	187	I	36"	18"	87"	1A	\$128.00
SHV0452	174	A	36"	18"	87"	1A	\$119.00
SHV0453	205	I	36"	18"	87"	2	\$138.00
SHV0454	192	A	36"	18"	87"	2	\$129.00
SHV0455	283	I	36"	18"	87"	3	\$188.00
SHV0456	270	A	36"	18"	87"	3	\$178.00
SHV0457	213	I	36"	18"	99"	1A	\$142.00
SHV0458	198	A	36"	18"	99"	1A	\$131.00
SHV0459	233	I	36"	18"	99"	2	\$154.00
SHV0460	218	A	36"	18"	99"	2	\$143.00
SHV0461	320	I	36"	18"	99"	3	\$209.00
SHV0462	305	A	36"	18"	99"	3	\$198.00
SHV0463	238	I	36"	18"	111"	1A	\$164.00
SHV0464	221	A	36"	18"	111"	1A	\$152.00

Stock No.	Weight (LBS)	Initial/Additional	W	D	H	Class	Price
SHV0480	301	A	36"	24"	87"	3	\$197.00
SHV0481	253	I	36"	24"	99"	1A	\$161.00
SHV0482	233	A	36"	24"	99"	1A	\$148.00
SHV0483	273	I	36"	24"	99"	2	\$173.00
SHV0484	253	A	36"	24"	99"	2	\$159.00
SHV0485	360	I	36"	24"	99"	3	\$233.00
SHV0486	340	A	36"	24"	99"	3	\$220.00
SHV0487	283	I	36"	24"	111"	1A	\$185.00
SHV0488	260	A	36"	24"	111"	1A	\$169.00
SHV0489	305	I	36"	24"	111"	2	\$198.00
SHV0490	282	A	36"	24"	111"	2	\$183.00
SHV0491	402	I	36"	24"	111"	3	\$264.00
SHV0492	379	A	36"	24"	111"	3	\$251.00

SHELVING

Nut & Bolt Build Your Own or Expand Components

Corner Post or Upright

Made from structural steel angles 1" x 1/8" thick, with 5/16" diameter holes on 1" centers, span the entire height of post for shelf spacing adjustment. Four post or uprights required for each unit. Heights: from 36" to 171". Other sizes available on request.



End Panels/Partitions

Made from 22-gauge steel (standard) and 24-gauge steel (clip-type), end panel partitions are used at ends of shelving units and at intermediate joints in rack formations. Mounting holes are spaced on 1" centers. Furnished for units 12" through 36" in depth. Panels for shelving 18" deep and more have an additional vertical row of holes in the center for attachment to shelves. Panels for ends of the units extend to the floor to enclose the base. Available in heights 39" through 111".



UPRIGHTS

Stock No.	Description	Weight (LBS)	Dim. (W/D/H)	Price
SHV4001 □□	Upright	3.0	1" x 1 3/4" x 36"	\$4.15
SHV4002 □□	Upright	3.3	1" x 1 3/4" x 39"	\$4.30
SHV4003 □□	Upright	4.0	1" x 1 3/4" x 48"	\$4.85

END PANELS/PARTITIONS

Stock No.	Description	Weight (LBS)	Dim. (W/H)	Price
SHV4039 □□	End Panel Partition	3.4	12" x 36"	\$4.00

38

1 Select a finish color.

2 Place 2-digit color code at end of stock no.

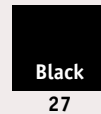
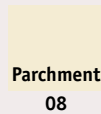

Additional colors may be available. Please call 202 305-3707 or 859 225-4824 for more information.

Stock No.	Description	Weight (LBS)	Dim. (W/D/H)	Price
SHV4004 □□	Upright	5.0	1" x 1 3/4" x 60"	\$5.40
SHV4005 □□	Upright	6.0	1" x 1 3/4" x 72"	\$6.25
SHV4006 □□	Upright	6.3	1" x 1 3/4" x 75"	\$6.50
SHV4007 □□	Upright	7.3	1" x 1 3/4" x 87"	\$6.85
SHV4008 □□	Upright	8.3	1" x 1 3/4" x 99"	\$7.25
SHV4009 □□	Upright	9.3	1" x 1 3/4" x 111"	\$8.15
SHV4010 □□	Upright	10.3	1" x 1 3/4" x 123"	\$10.45
SHV4011 □□	Upright	11.3	1" x 1 3/4" x 135"	\$11.15
SHV4012 □□	Upright	12.3	1" x 1 3/4" x 147"	\$11.80
SHV4013 □□	Upright	13.3	1" x 1 3/4" x 159"	\$12.45
SHV4014 □□	Upright	14.3	1" x 1 3/4" x 171"	\$17.25

Stock No.	Description	Weight (LBS)	Dim. (W/H)	Price
SHV4040 □□	End Panel Partition	3.7	12" x 39"	\$4.20
SHV4041 □□	End Panel/Partition	4.5	12" x 48"	\$4.55
SHV4042 □□	End Panel/Partition	5.7	12" x 60"	\$5.85
SHV4043 □□	End Panel/Partition	6.8	12" x 72"	\$6.35
SHV4044 □□	End Panel/Partition	7.1	12" x 75"	\$7.50
SHV4045 □□	End Panel/Partition	8.2	12" x 87"	\$7.70
SHV4046 □□	End Panel/Partition	9.3	12" x 99"	\$8.60
SHV4047 □□	End Panel/Partition	10.5	12" x 111"	\$10.25
SHV4048 □□	End Panel/Partition	4.3	15" x 36"	\$4.20
SHV4049 □□	End Panel/Partition	4.7	15" x 39"	\$4.95
SHV4050 □□	End Panel/Partition	5.7	15" x 48"	\$5.50
SHV4051 □□	End Panel/Partition	7.2	15" x 60"	\$6.75
SHV4052 □□	Partition	8.6	15" x 72"	\$8.25
SHV4053 □□	Partition	9.0	15" x 75"	\$8.50
SHV4054 □□	Partition	10.4	15" x 87"	\$9.60
SHV4055 □□	Partition	11.8	15" x 99"	\$13.45

Stock No.	Description	Weight (LBS)	Dim. (W/H)	Price
SHV4056 □□	Partition	13.3	15" x 111"	\$11.90
SHV4057 □□	Partition	5.2	18" x 36"	\$5.20
SHV4058 □□	Partition	5.6	18" x 39"	\$5.45
SHV4059 □□	Partition	6.9	18" x 48"	\$6.50
SHV4060 □□	Partition	8.7	18" x 60"	\$7.60
SHV4061 □□	Partition	10.4	18" x 72"	\$9.80
SHV4062 □□	Partition	10.8	18" x 75"	\$10.00
SHV4063 □□	Partition	12.6	18" x 87"	\$10.35
SHV4064 □□	Partition	14.3	18" x 99"	\$11.55
SHV4065 □□	Partition	16.0	18" x 111"	\$14.40
SHV4066 □□	Partition	7.1	24" x 36"	\$6.70
SHV4067 □□	Partition	7.7	24" x 39"	\$7.30
SHV4068 □□	Partition	9.5	24" x 48"	\$7.60
SHV4069 □□	Partition	11.8	24" x 60"	\$10.80

UNICOR BACK PANELS

Stock No.	Description	Weight (LBS)	Dim. (W/H)	Price
SHV4015 □□	Back Panel	8.0	24" x 39"	\$7.05
SHV4016 □□	Back Panel	15.5	24" x 75"	\$12.45
SHV4017 □□	Back Panel	18.0	24" x 87"	\$13.55
SHV4018 □□	Back Panel	20.5	24" x 99"	\$15.40
SHV4019 □□	Back Panel	23.0	24" x 111"	\$18.35
SHV4020 □□	Back Panel	9.5	30" x 39"	\$8.25
SHV4021 □□	Back Panel	19.1	30" x 75"	\$15.00
SHV4022 □□	Back Panel	22.3	30" x 87"	\$16.05
SHV4023 □□	Back Panel	25.5	30" x 99"	\$18.40
SHV4024 □□	Back Panel	28.7	30" x 111"	\$22.25
SHV4025 □□	Back Panel	11.5	36" x 39"	\$9.55
SHV4026 □□	Back Panel	22.9	36" x 75"	\$16.30

Back Panels

Made from 22-gauge steel (standard) and 24-gauge steel (clip-type), back panels are used at the back of shelves in single-faced units and between double-faced units. Mounting holes are spaced on 1" centers with an additional vertical row of holes in the center for attachment to shelves. Panels extend to floor to enclose base. Furnished for units in widths of 24" through 48" and heights from 39" through 111".



Stock No.	Description	Weight (LBS)	Dim. (W/H)	Price
SHV4070 □□	Partition	14.2	24" x 72"	\$12.35
SHV4071 □□	Partition	14.8	24" x 75"	\$12.90
SHV4072 □□	Partition	17.2	24" x 87"	\$13.30
SHV4073 □□	Partition	19.5	24" x 99"	\$15.00
SHV4074 □□	Partition	21.9	24" x 111"	\$18.30
SHV4075 □□	Partition	9.7	30" x 39"	\$7.70
SHV4076 □□	Partition	18.7	30" x 75"	\$14.40
SHV4077 □□	Partition	21.7	30" x 87"	\$15.95
SHV4078 □□	Partition	24.7	30" x 99"	\$17.95
SHV4079 □□	Partition	27.7	30" x 111"	\$22.00
SHV4080 □□	Partition	11.8	36" x 39"	\$9.35
SHV4081 □□	Partition	22.6	36" x 75"	\$16.30
SHV4082 □□	Partition	26.2	36" x 87"	\$18.50
SHV4083 □□	Partition	29.9	36" x 99"	\$20.70
SHV4084 □□	Partition	33.5	36" x 111"	\$25.50

Stock No.	Description	Weight (LBS)	Dim. (W/H)	Price
SHV4027 □□	Back Panel	26.7	36" x 87"	\$18.70
SHV4028 □□	Back Panel	30.5	36" x 99"	\$20.60
SHV4029 □□	Back Panel	34.3	36" x 111"	\$26.10
SHV4030 □□	Back Panel	13.8	42" x 39"	\$11.55
SHV4031 □□	Back Panel	27.0	42" x 75"	\$21.10
SHV4032 □□	Back Panel	31.4	42" x 87"	\$22.45
SHV4033 □□	Back Panel	35.8	42" x 99"	\$24.45
SHV4034 □□	Back Panel	40.2	42" x 111"	\$29.70
SHV4035 □□	Back Panel	30.0	48" x 75"	\$24.45
SHV4036 □□	Back Panel	36.0	48" x 87"	\$27.00
SHV4037 □□	Back Panel	40.0	48" x 99"	\$29.15
SHV4038 □□	Back Panel	46.0	48" x 111"	\$35.00

SHELVING

Nut & Bolt Build Your Own or Expand Components

Plain Shelf

Shelves come in one of four classes: Class 1, 1A, 2, and 3, depending on load requirements. Plain shelves are made from steel flanged down on all sides $1\frac{3}{16}$ " , with holes at sides and ends for assembly to uprights, and $\frac{5}{16}$ " holes spaced 2" apart on the surface for attachment of optional bin dividers. Shelves are available in depths of 12" through 36" and widths from 24" through 48". (Reinforcement angles sold separately.)

Stock No.	Description	Weight (LBS)	Dim. (W/D)	Price
SHV3015 □□	Plain Shelf	17.7	30" x 36"	\$11.50
SHV3016 □□	Plain Shelf	9.8	36" x 15"	\$8.00
SHV3017 □□	Plain Shelf	17.8	36" x 30"	\$12.00
SHV3018 □□	Plain Shelf	21.0	36" x 36"	\$13.25
SHV3019 □□	Plain Shelf	9.0	42" x 12"	\$8.00



UNICOR's shelf styles can be used with standard or clip-type shelving applications.

PLAIN SHELVES

Stock No.	Description	Weight (LBS)	Dim. (W/D)	Price
SHV3001 □□	Plain Shelf	5.5	24" x 12"	\$5.65
SHV3002 □□	Plain Shelf	7.9	24" x 18"	\$6.60
SHV3003 □□	Plain Shelf	10.3	24" x 24"	\$8.00
SHV3004 □□	Plain Shelf	8.2	36" x 12"	\$6.60
SHV3005 □□	Plain Shelf	11.4	36" x 18"	\$8.00
SHV3006 □□	Plain Shelf	14.6	36" x 24"	\$8.10
SHV3007 □□	Plain Shelf	6.7	24" x 15"	\$5.80
SHV3008 □□	Plain Shelf	12.7	24" x 30"	\$8.25
SHV3009 □□	Plain Shelf	15.1	24" x 36"	\$10.15
SHV3010 □□	Plain Shelf	6.5	30" x 12"	\$6.60
SHV3011 □□	Plain Shelf	7.9	30" x 15"	\$6.85
SHV3012 □□	Plain Shelf	9.3	30" x 18"	\$7.05
SHV3013 □□	Plain Shelf	12.1	30" x 24"	\$8.25
SHV3014 □□	Plain Shelf	14.9	30" x 30"	\$11.00

Stock No.	Description	Weight (LBS)	Dim. (W/D)	Price
SHV3020 □□	Plain Shelf	10.9	42" x 15"	\$8.55
SHV3021 □□	Plain Shelf	12.8	42" x 18"	\$9.65
SHV3022 □□	Plain Shelf	16.6	42" x 24"	\$11.00
SHV3023 □□	Plain Shelf	20.4	42" x 30"	\$13.25
SHV3024 □□	Plain Shelf	24.2	42" x 36"	\$16.50
SHV3025 □□	Plain Shelf	10.4	48" x 12"	\$8.10
SHV3026 □□	Plain Shelf	14.8	48" x 18"	\$10.70
SHV3027 □□	Plain Shelf	19.2	48" x 24"	\$11.70
SHV3028 □□	Plain Shelf	23.6	48" x 30"	\$14.55
SHV3029 □□	Plain Shelf	28	48" x 36"	\$18.50



Cornice Shelf

Made from 18-gauge steel, the cornice shelf gives a more finished appearance and smooth working surface over a plain top shelf of any unit. Available 2" thick in depths of 12" through 36" and widths from 24" through 42", the shelf is flanged 2" on the edge.

CORNICE SHELVES

Stock No.	Description	Weight (LBS)	Dim. (W/D)	Price
SHV3030 □□	Cornice Shelf	8.5	24" x 12"	\$13.65
SHV3031 □□	Cornice Shelf	10.0	24" x 15"	\$14.30
SHV3032 □□	Cornice Shelf	11.5	24" x 18"	\$14.85
SHV3033 □□	Cornice Shelf	14.5	24" x 24"	\$16.30
SHV3034 □□	Cornice Shelf	17.5	24" x 30"	\$17.50
SHV3035 □□	Cornice Shelf	20.5	24" x 36"	\$18.70
SHV3036 □□	Cornice Shelf	10.6	30" x 12"	\$14.20
SHV3037 □□	Cornice Shelf	12.4	30" x 15"	\$15.10
SHV3038 □□	Cornice Shelf	14.2	30" x 18"	\$15.85
SHV3039 □□	Cornice Shelf	17.8	30" x 24"	\$17.75

1 — Select a finish color.

2 — Place 2-digit color code at end of stock no.

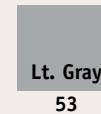
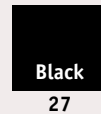
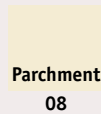

Additional colors may be available. Please call 202 305-3707 or 859 225-4824 for more information.

Stock No.	Description	Weight (LBS)	Dim. (W/D)	Price
SHV3040 □□	Cornice Shelf	21.4	30" x 30"	\$18.15
SHV3041 □□	Cornice Shelf	25.0	30" x 36"	\$20.50
SHV3042 □□	Cornice Shelf	13.2	36" x 12"	\$15.00
SHV3043 □□	Cornice Shelf	15.3	36" x 15"	\$15.70
SHV3044 □□	Cornice Shelf	17.4	36" x 18"	\$16.60
SHV3045 □□	Cornice Shelf	21.6	36" x 24"	\$18.80
SHV3046 □□	Cornice Shelf	25.8	36" x 30"	\$20.50
SHV3047 □□	Cornice Shelf	30.0	36" x 36"	\$22.10
SHV3048 □□	Cornice Shelf	14.8	42" x 12"	\$15.95
SHV3049 □□	Cornice Shelf	17.2	42" x 15"	\$17.20
SHV3050 □□	Cornice Shelf	19.6	42" x 18"	\$17.95
SHV3051 □□	Cornice Shelf	24.4	42" x 24"	\$20.15
SHV3052 □□	Cornice Shelf	29.2	42" x 30"	\$22.00
SHV3053 □□	Cornice Shelf	34.2	42" x 36"	\$23.90

SHELVING

Nut & Bolt Build Your Own or Expand Components

Ledge Shelf

Made from 16-gauge steel, ledge shelves have a finished appearance and smooth working surface. They come with two front and two rear brackets already welded on that are used to attach the shelf to the unit. Available in depths from 18" through 36" and widths from 24" through 42", the shelf is flanged 2" on the edge.

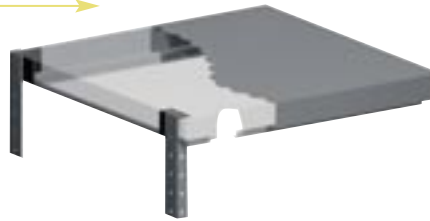

LEDGE SHELVES

Stock No.	Description	Weight (LBS)	Dim. (W/D)	Price
SHV3054 □□	Ledge Shelf	12.0	24" x 18"	\$17.70
SHV3055 □□	Ledge Shelf	14.9	24" x 24"	\$18.80
SHV3056 □□	Ledge Shelf	17.8	24" x 30"	\$20.70
SHV3057 □□	Ledge Shelf	20.7	24" x 36"	\$20.80

BRACING

Bracing for standard nut and bolt shelving includes the Angle-Sway Brace (used for the top, bottom, and middle shelves as stationary shelves), the Side Cross Brace (used to bolt to both sides of a shelving unit), the Rear Side Cross Brace (used to bolt to the rear of each shelving unit), or combinations of all three braces to make a shelving unit more rigid and stable.

42

1 Select a finish color.

2 Place 2-digit color code at end of stock no.

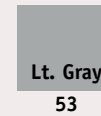
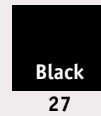
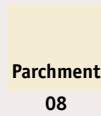

Additional colors may be available. Please call 202 305-3707 or 859 225-4824 for more information.

Stock No.	Description	Weight (LBS)	Dim. (W/D)	Price
SHV3058 □□	Ledge Shelf	14.5	30" x 18"	\$18.85
SHV3059 □□	Ledge Shelf	18.0	30" x 24"	\$21.00
SHV3060 □□	Ledge Shelf	21.5	30" x 30"	\$21.60
SHV3061 □□	Ledge Shelf	25.0	30" x 36"	\$22.10
SHV3062 □□	Ledge Shelf	17.2	36" x 18"	\$20.00
SHV3063 □□	Ledge Shelf	21.3	36" x 24"	\$21.60
SHV3064 □□	Ledge Shelf	25.4	36" x 30"	\$24.10
SHV3065 □□	Ledge Shelf	29.5	36" x 36"	\$24.30
SHV3066 □□	Ledge Shelf	19.9	42" x 18"	\$22.20
SHV3067 □□	Ledge Shelf	29.6	42" x 24"	\$23.10
SHV3068 □□	Ledge Shelf	29.3	42" x 30"	\$23.70
SHV3069 □□	Ledge Shelf	34.0	42" x 36"	\$25.50

Angle Sway Brace

Made from 13-gauge steel. Each angle leg is 4¹⁵/₁₆" long x 1³/₁₆" wide. The angle sway brace reinforces open type shelving and provides clear unobstructed shelf openings. Use with heavy or extra heavy loads.



Reinforcing Angle for Class 1A Shelf

A Class 1A shelf is reinforced with a structural steel angle in front for light shelf loads. One reinforcing angle is required in front. Shelf and reinforcing angles are priced separately. Size of brace is $\frac{1}{8}$ " x 1" x 1" x width of shelf. See shelving capacity chart on page 25.

REINFORCING ANGLES/BRACES

Stock No.	Description	Weight (LBS)	Dim. (D)	Price
SHV2016 □□	Side Cross Brace	2.2	12"	\$3.55/pair
SHV2017 □□	Side Cross Brace	2.3	15"	\$3.75/pair
SHV2018 □□	Side Cross Brace	2.4	18"	\$3.85/pair
SHV2019 □□	Side Cross Brace	2.6	24"	\$4.40/pair
SHV2020 □□	Side Cross Brace	2.9	30"	\$4.75/pair
SHV2021 □□	Rear Cross Brace	3.2	36"	\$5.15/pair

Reinforcing Angles for Class 3 Shelf

A Class 3 shelf requires heavier $\frac{3}{16}$ " reinforcing angles on the front and rear, two standard reinforcing angles in the center, and a side reinforcing angle on each end. The heavy front and rear angle is $\frac{3}{16}$ " x 1" x 1" x width of shelf. The center is $\frac{1}{8}$ " x 1" x 1" x width of shelf. The side is made from 10-gauge, cold rolled steel and is $\frac{5}{8}$ " x $1\frac{13}{16}$ " x $\frac{5}{8}$ " x width of shelf.

Stock No.	Description	Weight (LBS)	Dim. (W/D/H)	Price
SHV2001 □□	Front/Rear Angle	1.4	1" x 1" x 24"	\$1.25
SHV2002 □□	Front/Rear Angle	1.8	1" x 1" x 30"	\$1.45
SHV2003 □□	Front/Rear Angle	2.2	1" x 1" x 36"	\$1.60
SHV2004 □□	Front/Rear Angle	2.6	1" x 1" x 42"	\$1.65
SHV2005 □□	Front/Rear Angle	3.0	1" x 1" x 48"	\$1.95
SHV2006 □□	H.D. Front/Rear Angle	2.0	1" x 1" x 24"	\$1.35

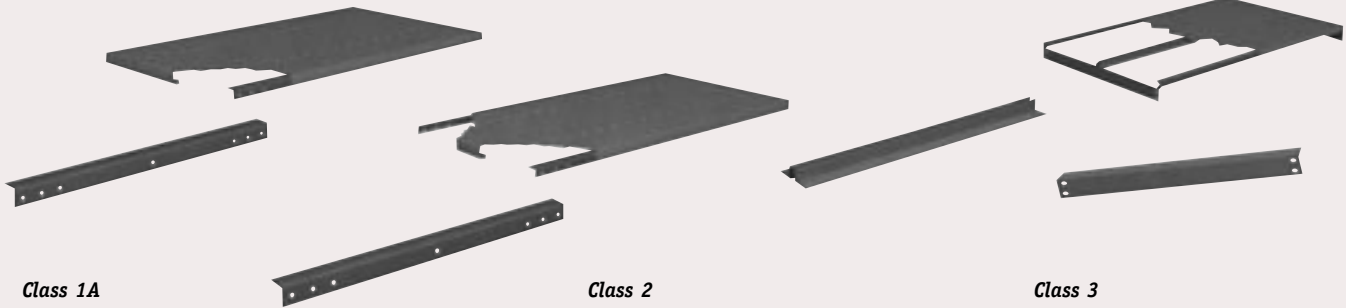

Stock No.	Description	Weight (LBS)	Dim. (W)	Price
SHV2022 □□	Rear Cross Brace	2.6	24"	\$4.55/pair
SHV2023 □□	Rear Cross Brace	2.9	30"	\$4.75/pair
SHV2024 □□	Rear Cross Brace	3.2	36"	\$5.25/pair
SHV2025 □□	Rear Cross Brace	3.6	42"	\$5.75/pair
SHV2026 □□	Rear Cross Brace	3.9	48"	\$6.50/pair

Reinforcing Angles for Class 2 Shelf

A Class 2 shelf is reinforced with angles in front and rear for medium shelf loads. Two per shelf are required—one in front and one in rear. Shelf and reinforcing angles are priced separately. Size of cross braces are $\frac{1}{8}$ " x 1" x 1" x width of shelf.

Stock No.	Description	Weight (LBS)	Dim. (W/D/H)	Price
SHV2007 □□	H.D. Front/Rear Angle	2.6	1" x 1" x 30"	\$1.65
SHV2008 □□	H.D. Front/Rear Angle	3.2	1" x 1" x 36"	\$2.00
SHV2009 □□	H.D. Front/Rear Angle	3.8	1" x 1" x 42"	\$2.20
SHV2010 □□	H.D. Front/Rear Angle	4.2	1" x 1" x 48"	\$2.35
SHV2011 □□	Side Angle	1.5	$\frac{5}{8}$ " x $1\frac{13}{16}$ " x 18"	\$1.65
SHV2012 □□	Side Angle	2.0	$\frac{5}{8}$ " x $1\frac{13}{16}$ " x 24"	\$1.80
SHV2013 □□	Side Angle	2.5	$\frac{5}{8}$ " x $1\frac{13}{16}$ " x 30"	\$2.00
SHV2014 □□	Side Angle	3.0	$\frac{5}{8}$ " x $1\frac{13}{16}$ " x 36"	\$2.20
SHV2015 □□	Angle Sway Strap	0.2	$4\frac{1}{16}$ " x $\frac{1}{16}$ "	\$.65

*Side Cross and Rear Cross Braces sold in pairs.

SHELVING

Steel Shelving Nut & Bolt Accessories

Flush Bars/Storage Drawer Guides

Made from 22-gauge steel, used at shelf ends (two per shelf) to prevent storage drawers, boxes, etc. from catching behind uprights.

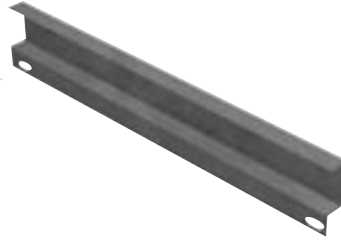

FLUSH BAR

Stock No.	Description	Weight (LBS)	Dim. (W)	Price
SHV5010 □□	Flush Bar	0.7	12"	\$1.10
SHV5011 □□	Flush Bar	1.1	18"	\$1.15
SHV5012 □□	Flush Bar	1.5	24"	\$1.35

Bin Fronts

Made from 18-gauge steel for use with closed shelving units to retain small articles on shelves. Has holes for securing to front of shelf and for attaching label holder.

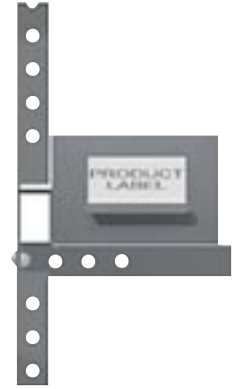

44

1 Select a finish color.

2 Place 2-digit color code at end of stock no.

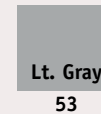
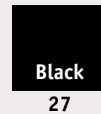
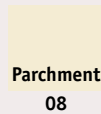

Additional colors may be available. Please call 202 305-3707 or 859 225-4824 for more information.

Base Strip or Closure

Made from 18-gauge steel (for standard units) and 22-gauge (for clip-type units) for closing the space between the bottom shelf and floor.

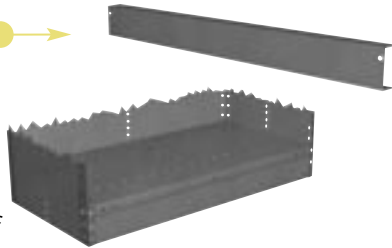

BASE STRIP

Stock No.	Description	Weight (LBS)	Dim. (W/H)	Price
SHV5091 □□	Base Strip	1.0	24" x 2"	\$1.65
SHV5092 □□	Base Strip	1.2	30" x 2"	\$1.80
SHV5093 □□	Base Strip	1.4	36" x 2"	\$1.90
SHV5094 □□	Base Strip	1.6	42" x 2"	\$2.35
SHV5095 □□	Base Strip	1.8	48" x 2"	\$2.45

BIN FRONT

Stock No.	Description	Weight (LBS)	Dim. (W/H)	Price
SHV5001 □□	Bin Front	2.0	24" x 3"	\$1.95
SHV5002 □□	Bin Front	2.5	30" x 3"	\$2.35
SHV5003 □□	Bin Front	3.0	36" x 3"	\$2.45
SHV5004 □□	Bin Front	3.5	42" x 3"	\$2.85
SHV5005 □□	Bin Front	2.2	24" x 4"	\$2.30
SHV5006 □□	Bin Front	2.8	30" x 4"	\$2.45
SHV5007 □□	Bin Front	3.4	36" x 4"	\$2.85
SHV5008 □□	Bin Front	4.0	42" x 4"	\$3.20
SHV5009 □□	Bin Front	4.6	48" x 4"	\$3.65

Doors

Made from 20-gauge steel, and are easily attached to shelving. Base strips (see page 42) are recommended to close the opening between the door frame and the floor.

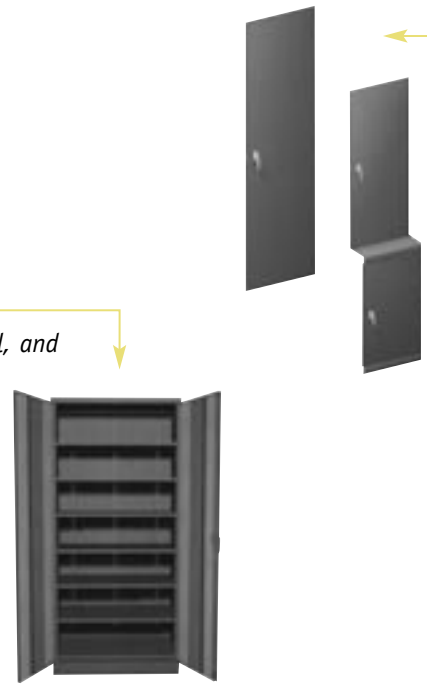

Single Doors

Single doors can be used on standard ledge or counter units up to 111" high, and can be attached to angle uprights. Available in swing or hinge type, single doors fit all types of closed shelving units with openings 24" wide. Doors include handles, integral paracentric key locks, and three-point, up-and-down bolt-locking mechanisms.

Double Doors

Double doors are made for openings 36" wide, and are available in various combinations. Left-hand doors have plain handles; right-hand doors have handles with integral paracentric key locks and three-point, up-and-down bolt-locking mechanisms. For units over 87" high, two or more pairs of doors are available for use in tiers.



SINGLE DOOR

Stock No.	Description	Weight (LBS)	Dim. (W/H)	Price
SHV5059 □□	Single Door	14.9	24" x 36"	\$34.20
SHV5060 □□	Single Door	16.2	24" x 39"	\$35.10
SHV5061 □□	Single Door	19.2	24" x 48"	\$38.10
SHV5062 □□	Single Door	23.5	24" x 60"	\$41.80
SHV5063 □□	Single Door	24.1	24" x 72"	\$45.10
SHV5064 □□	Single Door	28.4	24" x 75"	\$47.10
SHV5065 □□	Single Door	32.7	24" x 87"	\$49.50
SHV5066 □□	Single Door	39.3	24" x 99"	\$75.80
SHV5067 □□	Single Door	43.3	24" x 111"	\$79.55

DOUBLE DOOR

Stock No.	Description	Weight (LBS)	Dim. (W/H)	Price
SHV5068 □□	Double Door	23.9	36" x 36"	\$53.15
SHV5069 □□	Double Door	25.6	36" x 39"	\$55.35
SHV5070 □□	Double Door	30.8	36" x 48"	\$56.95
SHV5071 □□	Double Door	37.7	36" x 60"	\$62.60
SHV5072 □□	Double Door	44.6	36" x 72"	\$73.45
SHV5073 □□	Double Door	45.4	36" x 75"	\$74.40
SHV5074 □□	Double Door	52.3	36" x 87"	\$75.25
SHV5075 □□	Double Door	62.6	36" x 99"	\$113.75
SHV5076 □□	Double Door	69.4	36" x 111"	\$120.00
SHV5077 □□	Double Door	60.5	48" x 75"	\$83.15

SHELVING

Steel Shelving Nut & Bolt Accessories

Flanged Bin Divider

Full height dividers are used to create small, individual storage bins within the shelving unit, while angle and sliding dividers subdivide the shelf surface. Full height and angle dividers are fixed in place; sliding dividers are easily moved to accommodate changing storage needs.

FLANGED BIN DIVIDER

Stock No.	Weight (LBS)	Dim. (D/H)	Price
SHV5013 □□	.9	12" x 6"	\$1.45
SHV5014 □□	1.2	15" x 6"	\$1.65
SHV5015 □□	1.5	18" x 6"	\$1.90
SHV5016 □□	2.1	24" x 6"	\$2.20

Stock No.	Weight (LBS)	Dim. (D/H)	Price
SHV5032 □□	2.9	15" x 18"	\$2.65
SHV5033 □□	3.6	18" x 18"	\$2.90
SHV5034 □□	5.0	24" x 18"	\$3.75
SHV5035 □□	6.4	30" x 18"	\$4.75
SHV5036 □□	7.8	36" x 18"	\$5.30
SHV5037 □□	4.5	12" x 24"	\$3.65
SHV5038 □□	5.6	15" x 24"	\$4.50
SHV5039 □□	6.7	18" x 24"	\$4.95
SHV5040 □□	8.9	24" x 24"	\$6.95
SHV5045 □□	11.1	30" x 24"	\$7.70
SHV5046 □□	13.3	36" x 24"	\$8.40

46



Depth	Height				
12"	6	7½	9	12	16½
18"	6	7½	9	12	16½
24"	6		9	12	

Stock No.	Weight (LBS)	Dim. (D/H)	Price
SHV5017 □□	1.3	12" x 8"	\$1.55
SHV5018 □□	1.6	15" x 8"	\$1.90
SHV5019 □□	1.9	18" x 8"	\$2.00
SHV5020 □□	2.5	24" x 8"	\$2.30
SHV5021 □□	1.5	12" x 10"	\$1.65
SHV5022 □□	1.8	15" x 10"	\$1.85
SHV5023 □□	2.2	18" x 10"	\$2.20
SHV5024 □□	3.0	24" x 10"	\$2.45
SHV5025 □□	1.9	12" x 12"	\$1.85
SHV5026 □□	2.3	15" x 12"	\$2.00
SHV5027 □□	2.7	18" x 12"	\$2.10
SHV5028 □□	3.5	24" x 12"	\$2.90
SHV5029 □□	4.3	30" x 12"	\$3.65
SHV5030 □□	5.1	36" x 12"	\$3.75
SHV5031 □□	2.2	18" x 12"	\$2.30

Angle Type Bin Divider

Made from 16-gauge steel, with matching holes in bottom flange for securing to shelf bin divider holes with bolts or self-inserting clips, for division of shelf openings into smaller compartments.

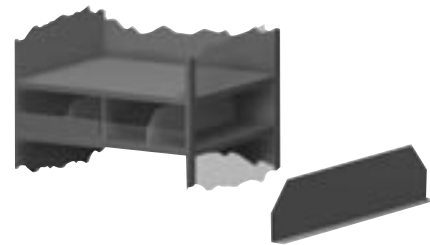

ANGLE BIN DIVIDER

Stock No.	Weight (LBS)	Dim. (D/H)	Price
SHV5047 □□	1.0	12" x 4"	\$1.20
SHV5048 □□	1.3	15" x 4"	\$1.30
SHV5049 □□	1.6	18" x 4"	\$1.35

Storage Drawers

Made from 20-gauge steel with combined pull handle/label holders for 1½" x 3" cards. Each drawer has slots for dividers on 1" centers and stops to prevent drawers from falling when fully extended. Note: Two flush bars per shelf are recommended at shelf ends for all drawers to prevent drawers catching behind upright.

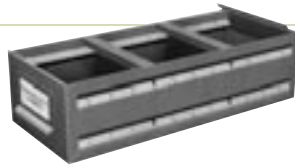

DRAWERS

Stock No.	Description	Weight (LBS)	Dim. (D/W/H)	Price
SHV5050	Storage Drawer w/2 Dividers	4.6	5⅝" x 17¼" x 4⅜"	\$6.95
SHV5051	Drawer Only	4.0	5⅝" x 17¼" x 4⅜"	\$6.20
SHV5053	Storage Drawer w/2 Dividers	4.0	5⅝" x 11⅞" x 4⅜"	\$6.60
SHV5054	Drawer Only	3.6	5⅝" x 11⅞" x 4⅜"	\$6.40
SHV5056	Storage Drawer w/2 Dividers	8.0	11⅞" x 17¼" x 4⅜"	\$7.70
SHV5057	Drawer Only	6.0	11⅞" x 17¼" x 4⅜"	\$7.05

Label Holders

Made from 22-gauge steel, holders are 1" high with edges turned back to accommodate a 1⅝" label. Two holes at each end and one in center match holes in shelf face with self-inserting clips for easy fastening. For shelves 24" to 48" wide.

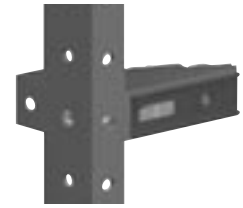

ACCESSORIES: LABEL HOLDER

Stock No.	Weight (LBS)	Dim. (W)	Price
SHV5086	0.3	24"	\$.70
SHV5087	0.4	30"	\$.80
SHV5088	0.5	36"	\$.90
SHV5089	0.6	42"	\$1.00
SHV5090	0.7	48"	\$1.10

1 Select a finish color.

2 Place 2-digit color code at end of stock no.

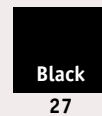
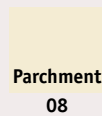

Additional colors may be available. Please call 202 305-3707 or 859 225-4824 for more information.

Drawer Dividers

Drawers have two dividers each, for use in 36" wide shelving units with depths of either 12" or 18". Inserts are made of 22-gauge steel, are adjustable on 1" centers, and accommodate label inserts 1½" high.

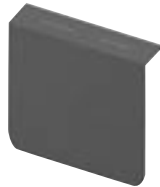

DRAWER DIVIDER

Stock No.	Description	Weight (LBS)	Dim. (D/H)	Price
SHV5055	Divider Only	0.2	5⅝" x 4⅜"	\$.55
SHV5058	Divider Only	1.0	5⅝" x 4⅜"	\$.70



18-Drawer and 24-Drawer Inserts

Overall dimensions are 10⅞"H x 33⅝"W for use in shelving units 36" wide. Made for 12" and 18" shelf depths, drawers have two dividers each, adjustable on 1" centers, and accommodate label inserts 1½" high. Drawers are designed to prevent falling when fully extended.

ACCESSORIES: MULTI-DRAWER INSERTS

Stock No.	Description	Weight (LBS)	Dim. (D/H)	Price
SHV5078	18 Drawer Insert for 12" deep shelf	80.0	10⅞" x 33⅝"	\$260.00
SHV5079	Divider Only	0.4		\$.45
SHV5080	18 Drawer Insert for 18" deep shelf	110.0	10⅞" x 33⅝"	\$270.00
SHV5082	24 Drawer Insert for 18" deep shelf	120	10⅞" x 33⅝"	\$270.00
SHV5083	Divider Only	0.1		\$.45
SHV5084	24 Drawer Insert for 12" deep shelf	90	10⅞" x 33⅝"	\$280.00

SHELVING

Clip-Type Components

Clip-Type Shelving/Angle Uprights

The standard angle upright design uses four adjustable clips per shelf to make shelf height adjustments very easy for all end users. Angle posts are available in 1½" increments.

Angle Posts

Angle posts are available in 1½" increments.

ANGLE POSTS

Stock No.	Weight (LBS)	Dim. (H)	Price
RC100017 □□	2.0	3'-1"	\$5.50
RC100019 □□	2.1	3'-4"	\$5.50
RC100025 □□	2.6	4'-1"	\$6.65

Beaded Posts

Beaded posts are available in 1½" increments. For sizes not shown, use price of next higher size and show stock number as NPN when ordering.



BEADED POSTS

Stock No.	Weight (LBS)	Dim. (H)	Price
RC107017 □□	4.3	3'-1"	\$11.65
RC107019 □□	4.6	3'-4"	\$12.25
RC107025 □□	5.6	4'-1"	\$14.90

48

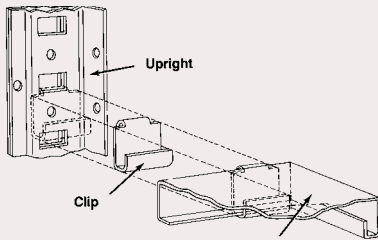

Stock No.	Weight (LBS)	Dim. (H)	Price
RC100033 □□	3.2	5'-1"	\$8.40
RC100041 □□	3.9	6'-1"	\$9.30
RC100049 □□	4.5	7'-1"	\$10.00
RC100057 □□	5.1	8'-1"	\$12.05
RC100065 □□	5.8	9'-1"	\$13.85
RC100073 □□	6.4	10'-1"	\$14.45
RC100081 □□	7.0	11'-1"	\$16.95
RC100089 □□	7.7	12'-1"	\$17.45
RC100090 □□	8.3	13'-1"	\$22.95
RC100091 □□	8.9	14'-1"	\$23.85
RC100092 □□	9.6	15'-1"	\$26.35
RC100093 □□	10.2	16'-1"	\$28.60

Stock No.	Weight (LBS)	Dim. (H)	Price
RC107033 □□	7.0	5'-1"	\$17.25
RC107041 □□	8.4	6'-1"	\$19.70
RC107049 □□	9.8	7'-1"	\$21.80
RC107057 □□	11.1	8'-1"	\$24.95
RC107065 □□	12.5	9'-1"	\$29.30
RC107073 □□	13.9	10'-1"	\$30.85
RC107081 □□	15.3	11'-1"	\$35.50
RC107089 □□	16.6	12'-1"	\$36.30
RC107090 □□	18.0	13'-1"	\$48.85
RC107091 □□	19.4	14'-1"	\$51.40
RC107092 □□	20.8	15'-1"	\$55.05
RC107093 □□	22.1	16'-1"	\$58.45

Cross Strap Brace

Made from $\frac{1}{8}$ " thick steel strap 1" wide with $\frac{5}{16}$ " holes at each end for bolting to post.

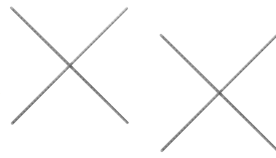

cross and side strap braces sold in pairs (as shown)

REAR CROSS BRACE

Stock No.	Weight (LBS)	Dim. (W/D/H)	Price
SHV5128 □□	5.8	36" x 1" x $\frac{1}{8}$ "	\$7.75/pair
SHV5129 □□	6.8	42" x 1" x $\frac{1}{8}$ "	\$8.50/pair
SHV5130 □□	7.8	48" x 1" x $\frac{1}{8}$ "	\$9.00/pair

SIDE CROSS BRACE

Stock No.	Weight (LBS)	Dim. (W/D/H)	Price
SHV5131 □□	4.0	12" x 1" x $\frac{1}{8}$ "	\$4.80/pair
SHV5132 □□	4.4	18" x 1" x $\frac{1}{8}$ "	\$5.00/pair
SHV5133 □□	5.0	24" x 1" x $\frac{1}{8}$ "	\$5.70/pair
SHV5134 □□	5.0	30" x 1" x $\frac{1}{8}$ "	\$6.00/pair

Stock No.	Weight (LBS)	Dim. (D/H)	Price
RC101163 □□	2.7	15" x 3'-1"	\$9.00
RC101165 □□	3.0	15" x 3'-4"	\$9.35
RC101171 □□	3.6	15" x 4'-1"	\$11.35
RC101179 □□	4.5	15" x 5'-1"	\$13.95
RC101187 □□	5.4	15" x 6'-1"	\$17.75
RC101195 □□	6.3	15" x 7'-1"	\$19.30
RC101203 □□	7.2	15" x 8'-1"	\$23.40
RC101236 □□	3.4	18" x 3'-1"	\$10.05
RC101238 □□	3.7	18" x 3'-4"	\$10.25
RC101244 □□	4.5	18" x 4'-1"	\$13.35
RC101252 □□	5.6	18" x 5'-1"	\$16.85
RC101260 □□	6.7	18" x 6'-1"	\$19.70
RC101268 □□	7.8	18" x 7'-1"	\$21.30
RC101276 □□	8.9	18" x 8'-1"	\$26.40
RC101309 □□	4.7	24" x 3'-1"	\$14.95

1 Select a finish color.

2 Place 2-digit color code at end of stock no.

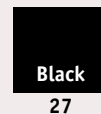
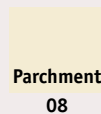

Additional colors may be available. Please call 202 305-3707 or 859 225-4824 for more information.

Side Panels

Side sheets are available in $1\frac{1}{2}$ " increments.



SIDE PANELS

Stock No.	Weight (LBS)	Dim. (D/H)	Price
RC101090 □□	2.1	12" x 3'-1"	\$7.35
RC101092 □□	2.2	12" x 3'-4"	\$7.55
RC101098 □□	2.7	12" x 4'-1"	\$9.30
RC101106 □□	3.4	12" x 5'-1"	\$11.65
RC101114 □□	4.1	12" x 6'-1"	\$14.00
RC101122 □□	4.7	12" x 7'-1"	\$16.00
RC101130 □□	5.4	12" x 8'-1"	\$18.00

Stock No.	Weight (LBS)	Dim. (D/H)	Price
RC101311 □□	5.1	24" x 3'-4"	\$15.20
RC101317 □□	6.3	24" x 4'-1"	\$19.00
RC101325 □□	7.8	24" x 5'-1"	\$23.95
RC101333 □□	9.3	24" x 6'-1"	\$26.05
RC101341 □□	10.9	24" x 7'-1"	\$29.10
RC101349 □□	12.4	24" x 8'-1"	\$34.10
RC101406 □□	12.0	30" x 6'-1"	\$34.95
RC101414 □□	14.0	30" x 7'-1"	\$35.65
RC101422 □□	16.0	30" x 8'-1"	\$44.85
RC101512 □□	15.0	32" x 7'-1"	\$40.15
RC101513 □□	17.1	32" x 8'-1"	\$47.35
RC101479 □□	14.6	36" x 6'-1"	\$40.75
RC101487 □□	17.0	36" x 7'-1"	\$44.90
RC101495 □□	19.4	36" x 8'-1"	\$52.05

SHELVING

Clip-Type Components

Back Panels

Back sheets are available in 1½" increments.

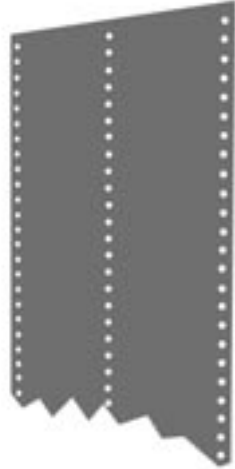

Stock No.	Weight (LBS)	Dim. (W/H)	Price
RC105163 □□	7.7	36" x 3'-1"	\$22.50
RC105165 □□	8.4	36" x 3'-4"	\$22.55
RC105171 □□	10.3	36" x 4'-1"	\$28.60
RC105179 □□	12.8	36" x 5'-1"	\$35.80
RC105187 □□	15.3	36" x 6'-1"	\$40.05
RC105195 □□	17.9	36" x 7'-1"	\$43.50
RC105203 □□	20.4	36" x 8'-1"	\$54.00
RC105236 □□	9.0	42" x 3'-1"	\$26.15

50

1 — Select a finish color.

2 — Place 2-digit color code at end of stock no.

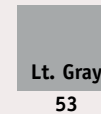
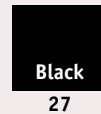
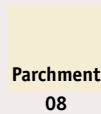

Additional colors may be available. Please call 202 305-3707 or 859 225-4824 for more information.

BACK PANELS

Stock No.	Weight (LBS)	Dim. (W/H)	Price
RC105033 □□	8.4	24" x 5'-1"	\$26.60
RC105041 □□	10.0	24" x 6'-1"	\$31.30
RC105049 □□	11.8	24" x 7'-1"	\$35.60
RC105057 □□	13.4	24" x 8'-1"	\$40.35
RC105106 □□	10.6	30" x 5'-1"	\$31.30
RC105114 □□	12.7	30" x 6'-1"	\$37.70
RC105122 □□	14.8	30" x 7'-1"	\$43.00
RC105130 □□	16.9	30" x 8'-1"	\$48.65

Stock No.	Weight (LBS)	Dim. (W/H)	Price
RC105238 □□	9.8	42" x 3'-4"	\$26.45
RC105244 □□	12.1	42" x 4'-1"	\$33.75
RC105252 □□	15.0	42" x 5'-1"	\$41.15
RC105260 □□	18.0	42" x 6'-1"	\$49.35
RC105268 □□	20.9	42" x 7'-1"	\$54.15
RC105309 □□	10.3	48" x 3'-1"	\$31.80
RC105311 □□	11.3	48" x 3'-4"	\$32.55
RC105317 □□	13.8	48" x 4'-1"	\$40.40
RC105325 □□	17.2	48" x 5'-1"	\$50.15
RC105333 □□	20.6	48" x 6'-1"	\$57.25
RC105341 □□	24.0	48" x 7'-1"	\$63.40

Base Strip For Angle Posts

When 1½" front bases are used, half shelf clips are furnished for the bottom shelf. Add 1" to base height to determine elevation of first shelf.

Base Strip For Beaded Posts

When 1½" front bases are used, half shelf clips are furnished for the bottom shelf. Add 1" to base height to determine elevation of first shelf.



BASE STRIP FOR ANGLE POSTS

Stock No.	Weight (LBS)	Dim. (W/H)	Price
RC107970 □□	0.8	24" x 1½"	\$4.40
RC107971 □□	0.9	30" x 1½"	\$4.55
RC107972 □□	1.0	36" x 1½"	\$4.80
RC107973 □□	1.1	42" x 1½"	\$4.80
RC107974 □□	1.2	48" x 1½"	\$4.90
RC107976 □□	0.8	24" x 3"	\$5.00
RC107977 □□	1.0	30" x 3"	\$5.00
RC107978 □□	1.1	36" x 3"	\$5.05
RC107979 □□	1.3	42" x 3"	\$5.45
RC107980 □□	1.5	48" x 3"	\$5.65

BASE STRIP FOR BEADED POSTS

Stock No.	Weight (LBS)	Dim. (W/H)	Price
RC107990 □□	0.8	24" x 1½"	\$4.40
RC107991 □□	0.9	30" x 1½"	\$4.55
RC107992 □□	1.0	36" x 1½"	\$4.60
RC107993 □□	1.1	42" x 1½"	\$4.80
RC107994 □□	1.2	48" x 1½"	\$4.90
RC107996 □□	0.8	24" x 3"	\$5.05
RC107997 □□	1.0	30" x 3"	\$5.05
RC107998 □□	1.1	36" x 3"	\$5.15
RC107999 □□	1.3	42" x 3"	\$5.45
RC108000 □□	1.5	48" x 3"	\$5.65

SHELVING

Counter Shelving Nut & Bolt

Counter Shelving Units

Counter shelving has a smooth top ideal for a work surface. The counter top plus the top and bottom shelves are fixed. Additional units are the same as the initial unit without one partition or end panel. Units are 39" high, depths range from 12" to 24", and the units are available in three load capacities. This shelving is available in a variety of standard or custom colors.

COUNTER SHELVING UNITS

Stock No.	Weight (LBS)	Initial/Additional	W	D	H	Class	Price
SHV0601 □□	63	I	24"	12"	39"	1A	\$65.00
SHV0602 □□	57	A	24"	12"	39"	1A	\$61.00
SHV0603 □□	66	I	24"	12"	39"	2	\$68.00

52

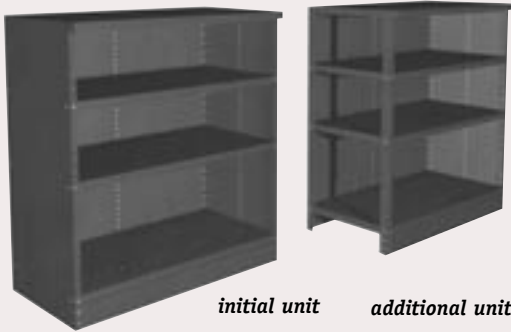

Order an initial unit to be placed at the end of each row break of shelving units and additional units for all units within a row of shelving.

Stock No.	Weight (LBS)	Initial/Additional	W	D	H	Class	Price
SHV0604 □□	63	A	24"	12"	39"	2	\$65.00
SHV0605 □□	70	I	24"	12"	39"	3	\$72.00
SHV0606 □□	67	A	24"	12"	39"	3	\$66.00
SHV0607 □□	83	I	36"	12"	39"	1A	\$75.00
SHV0608 □□	80	A	36"	12"	39"	1A	\$72.00
SHV0609 □□	91	I	36"	12"	39"	2	\$81.00
SHV0610 □□	88	A	36"	12"	39"	2	\$77.00
SHV0611 □□	99	I	36"	12"	39"	3	\$85.00
SHV0612 □□	95	A	36"	12"	39"	3	\$80.00
SHV0613 □□	68	I	24"	15"	39"	1A	\$71.00
SHV0614 □□	64	A	24"	15"	39"	1A	\$65.00
SHV0615 □□	74	I	24"	15"	39"	2	\$74.00
SHV0616 □□	70	A	24"	15"	39"	2	\$71.00
SHV0617 □□	78	I	24"	15"	39"	3	\$75.00
SHV0618 □□	74	A	24"	15"	39"	3	\$72.00

Stock No.	Weight (LBS)	Initial/Additional	W	D	H	Class	Price
SHV0619 □□	93	I	36"	15"	39"	1A	\$81.00
SHV0620 □□	89	A	36"	15"	39"	1A	\$77.00
SHV0621 □□	102	I	36"	15"	39"	2	\$87.00
SHV0622 □□	98	A	36"	15"	39"	2	\$82.00
SHV0623 □□	110	I	36"	15"	39"	3	\$92.00
SHV0624 □□	106	A	36"	15"	39"	3	\$86.00
SHV0625 □□	76	I	24"	18"	39"	1A	\$73.00
SHV0626 □□	71	A	24"	18"	39"	1A	\$67.00
SHV0627 □□	82	I	24"	18"	39"	2	\$77.00
SHV0628 □□	77	A	24"	18"	39"	2	\$73.00
SHV0629 □□	111	I	24"	18"	39"	3	\$99.00
SHV0630 □□	107	A	24"	18"	39"	3	\$94.00

Stock No.	Weight (LBS)	Initial/Additional	W	D	H	Class	Price
SHV0646 □□	127	A	36"	24"	39"	2	\$98.00
SHV0647 □□	177	I	36"	24"	39"	3	\$135.00
SHV0648 □□	169	A	36"	24"	39"	3	\$128.00
SHV0649 □□	110	I	24"	30"	39"	1A	\$91.00
SHV0650 □□	100	A	24"	30"	39"	1A	\$82.00
SHV0651 □□	116	I	24"	30"	39"	2	\$94.00
SHV0652 □□	106	A	24"	30"	39"	2	\$87.00
SHV0653 □□	153	I	24"	30"	39"	3	\$119.00
SHV0654 □□	143	A	24"	30"	39"	3	\$114.00
SHV0655 □□	146	I	36"	30"	39"	1A	\$111.00
SHV0656 □□	136	A	36"	30"	39"	1A	\$104.00
SHV0657 □□	155	I	36"	30"	39"	2	\$118.00

1 — Select a finish color.

2 — Place 2-digit color code at end of stock no.

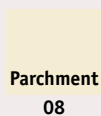

Additional colors may be available. Please call 202 305-3707 or 859 225-4824 for more information.

Stock No.	Weight (LBS)	Initial/Additional	W	D	H	Class	Price
SHV0631 □□	103	I	36"	18"	39"	1A	\$86.00
SHV0632 □□	98	A	36"	18"	39"	1A	\$82.00
SHV0633 □□	112	I	36"	18"	39"	2	\$93.00
SHV0634 □□	106	A	36"	18"	39"	2	\$87.00
SHV0635 □□	151	I	36"	18"	39"	3	\$119.00
SHV0636 □□	146	A	36"	18"	39"	3	\$114.00
SHV0637 □□	94	I	24"	24"	39"	1A	\$83.00
SHV0638 □□	86	A	24"	24"	39"	1A	\$77.00
SHV0639 □□	100	I	24"	24"	39"	2	\$88.00
SHV0640 □□	92	A	24"	24"	39"	2	\$81.00
SHV0641 □□	133	I	24"	24"	39"	3	\$113.00
SHV0642 □□	125	A	24"	24"	39"	3	\$106.00
SHV0643 □□	126	I	36"	24"	39"	1A	\$99.00
SHV0644 □□	118	A	36"	24"	39"	1A	\$93.00
SHV0645 □□	135	I	36"	24"	39"	2	\$104.00

Stock No.	Weight (LBS)	Initial/Additional	W	D	H	Class	Price
SHV0658 □□	145	A	36"	30"	39"	2	\$110.00
SHV0659 □□	201	I	36"	30"	39"	3	\$150.00
SHV0660 □□	191	A	36"	30"	39"	3	\$141.00
SHV0661 □□	127	I	24"	36"	39"	1A	\$99.00
SHV0662 □□	115	A	24"	36"	39"	1A	\$91.00
SHV0663 □□	132	I	24"	36"	39"	2	\$104.00
SHV0664 □□	120	A	24"	36"	39"	2	\$94.00
SHV0665 □□	173	I	24"	36"	39"	3	\$132.00
SHV0666 □□	161	A	24"	36"	39"	3	\$123.00
SHV0667 □□	167	I	36"	36"	39"	1A	\$123.00
SHV0668 □□	156	A	36"	36"	39"	1A	\$113.00
SHV0669 □□	176	I	36"	36"	39"	2	\$128.00
SHV0670 □□	164	A	36"	36"	39"	2	\$119.00
SHV0671 □□	226	I	36"	36"	39"	3	\$163.00
SHV0672 □□	214	A	36"	36"	39"	3	\$153.00

SHELVING

Ledge Shelving Nut & Bolt

Ledge Shelving Units

Ledge shelving has a smooth work surface. The ledge and the top and bottom shelves are fixed, and the other shelves are adjustable on 1" centers. Additional units are the same as the initial unit without one partition or end panel. Widths range from 24" to 36" and the units are available in three load capacities. Comes in a variety of colors. See inside back cover for selection. Shelving accessories can be ordered for this shelving (see page 42).

54



ledge shelving, initial unit and one additional unit

NOTE: Order an initial unit to be placed at the end of each row break of shelving units and additional units for all units within a row of shelving.

Stock No.	Weight (LBS)	Initial/ Additional	Width Depth	Abv Depth	Blw	Height	Class	Price
SHV0815	179	I	24"	12"	24"	99"	2	\$154.00
SHV0816	165	A	24"	12"	24"	99"	2	\$143.00
SHV0817	210	I	24"	12"	24"	99"	3	\$174.00
SHV0818	196	A	24"	12"	24"	99"	3	\$163.00
SHV0819	184	I	24"	12"	24"	111"	1A	\$160.00
SHV0820	170	A	24"	12"	24"	111"	1A	\$147.00
SHV0821	197	I	24"	12"	24"	111"	2	\$170.00
SHV0822	182	A	24"	12"	24"	111"	2	\$155.00
SHV0823	229	I	24"	12"	24"	111"	3	\$191.00
SHV0824	214	A	24"	12"	24"	111"	3	\$178.00
SHV0825	141	I	24"	15"	24"	75"	1A	\$126.00
SHV0826	129	A	24"	15"	24"	75"	1A	\$114.00

LEDGE SHELVING UNITS

Stock No.	Weight (LBS)	Initial/ Additional	Width Depth	Abv Depth	Blw	Height	Class	Price
SHV0801	136	I	24"	12"	24"	75"	1A	\$123.00
SHV0802	124	A	24"	12"	24"	75"	1A	\$112.00
SHV0803	144	I	24"	12"	24"	75"	2	\$130.00
SHV0804	132	A	24"	12"	24"	75"	2	\$119.00
SHV0805	172	I	24"	12"	24"	75"	3	\$144.00
SHV0806	160	A	24"	12"	24"	75"	3	\$138.00
SHV0807	152	I	24"	12"	24"	87"	1A	\$133.00
SHV0808	139	A	24"	12"	24"	87"	1A	\$121.00
SHV0809	161	I	24"	12"	24"	87"	2	\$141.00
SHV0810	148	A	24"	12"	24"	87"	2	\$130.00
SHV0811	191	I	24"	12"	24"	87"	3	\$161.00
SHV0812	178	A	24"	12"	24"	87"	3	\$150.00
SHV0813	166	I	24"	12"	24"	99"	1A	\$146.00
SHV0814	152	A	24"	12"	24"	99"	1A	\$133.00

Stock No.	Weight (LBS)	Initial/ Additional	Width Depth	Abv Depth	Blw	Height	Class	Price
SHV0827	149	I	24"	15"	24"	75"	2	\$132.00
SHV0828	137	A	24"	15"	24"	75"	2	\$120.00
SHV0829	178	I	24"	15"	24"	75"	3	\$151.00
SHV0830	166	A	24"	15"	24"	75"	3	\$140.00
SHV0831	159	I	24"	15"	24"	87"	1A	\$138.00
SHV0832	146	A	24"	15"	24"	87"	1A	\$126.00
SHV0833	168	I	24"	15"	24"	87"	2	\$145.00
SHV0834	154	A	24"	15"	24"	87"	2	\$133.00
SHV0835	198	I	24"	15"	24"	87"	3	\$165.00
SHV0836	184	A	24"	15"	24"	87"	3	\$153.00
SHV0837	177	I	24"	15"	24"	99"	1A	\$151.00
SHV0838	161	A	24"	15"	24"	99"	1A	\$138.00
SHV0839	188	I	24"	15"	24"	99"	2	\$160.00
SHV0840	172	A	24"	15"	24"	99"	2	\$147.00
SHV0841	219	I	24"	15"	24"	99"	3	\$179.00

LEDGE SHELVING UNITS

Stock No.	Weight (LBS)	Initial/Additional	Width Depth	Abv Depth	Blw	Height	Class	Price
SHV0842	203	A	24"	15"	24"	99"	3	\$166.00
SHV0843	195	I	24"	15"	24"	111"	1A	\$167.00
SHV0844	178	A	24"	15"	24"	111"	1A	\$153.00
SHV0845	207	I	24"	15"	24"	111"	2	\$177.00
SHV0846	190	A	24"	15"	24"	111"	2	\$163.00
SHV0847	239	I	24"	15"	24"	111"	3	\$198.00
SHV0848	222	A	24"	15"	24"	111"	3	\$183.00
SHV0849	160	I	24"	18"	30"	75"	1A	\$134.00
SHV0850	149	A	24"	18"	30"	75"	1A	\$121.00
SHV0851	169	I	24"	18"	30"	75"	2	\$141.00
SHV0852	154	A	24"	18"	30"	75"	2	\$128.00
SHV0853	218	I	24"	18"	30"	75"	3	\$177.00
SHV0854	203	A	24"	18"	30"	75"	3	\$165.00
SHV0855	180	I	24"	18"	30"	87"	1A	\$147.00

Stock No.	Weight (LBS)	Initial/Additional	Width Depth	Abv Depth	Blw	Height	Class	Price
SHV0872	284	A	24"	18"	30"	111"	3	\$225.00
SHV0873	176	I	24"	18"	36"	75"	1A	\$151.00
SHV0874	159	A	24"	18"	36"	75"	1A	\$128.00
SHV0875	184	I	24"	18"	36"	75"	2	\$148.00
SHV0876	167	A	24"	18"	36"	75"	2	\$135.00
SHV0877	237	I	24"	18"	36"	75"	3	\$186.00
SHV0878	220	A	24"	18"	36"	75"	3	\$172.00
SHV0879	195	I	24"	18"	36"	87"	1A	\$154.00
SHV0880	176	A	24"	18"	36"	87"	1A	\$148.00
SHV0881	205	I	24"	18"	36"	87"	2	\$163.00
SHV0882	186	A	24"	18"	36"	87"	2	\$147.00
SHV0883	265	I	24"	18"	36"	87"	3	\$205.00
SHV0884	246	A	24"	18"	36"	87"	3	\$191.00
SHV0885	215	I	24"	18"	36"	99"	1A	\$170.00

1 Select a finish color.

2 Place 2-digit color code at end of stock no.

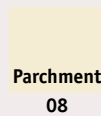

Additional colors may be available. Please call 202 305-3707 or 859 225-4824 for more information.

Stock No.	Weight (LBS)	Initial/Additional	Width Depth	Abv Depth	Blw	Height	Class	Price
SHV0856	163	A	24"	18"	30"	87"	1A	\$134.00
SHV0857	190	I	24"	18"	30"	87"	2	\$154.00
SHV0858	173	A	24"	18"	30"	87"	2	\$141.00
SHV0859	247	I	24"	18"	30"	87"	3	\$197.00
SHV0860	230	A	24"	18"	30"	87"	3	\$183.00
SHV0861	200	I	24"	18"	30"	99"	1A	\$161.00
SHV0862	182	A	24"	18"	30"	99"	1A	\$147.00
SHV0863	211	I	24"	18"	30"	99"	2	\$171.00
SHV0864	193	A	24"	18"	30"	99"	2	\$154.00
SHV0865	275	I	24"	18"	30"	99"	3	\$217.00
SHV0866	257	A	24"	18"	30"	99"	3	\$198.00
SHV0867	220	I	24"	18"	30"	111"	1A	\$179.00
SHV0868	200	A	24"	18"	30"	111"	1A	\$163.00
SHV0869	232	I	24"	18"	30"	111"	2	\$189.00
SHV0870	212	A	24"	18"	30"	111"	2	\$172.00
SHV0871	304	I	24"	18"	30"	111"	3	\$242.00

Stock No.	Weight (LBS)	Initial/Additional	Width Depth	Abv Depth	Blw	Height	Class	Price
SHV0886	195	A	24"	18"	36"	99"	1A	\$152.00
SHV0887	226	I	24"	18"	36"	99"	2	\$177.00
SHV0888	206	A	24"	18"	36"	99"	2	\$161.00
SHV0889	294	I	24"	18"	36"	99"	3	\$226.00
SHV0890	274	A	24"	18"	36"	99"	3	\$209.00
SHV0891	235	I	24"	18"	36"	111"	1A	\$186.00
SHV0892	213	A	24"	18"	36"	111"	1A	\$168.00
SHV0893	247	I	24"	18"	36"	111"	2	\$197.00
SHV0894	225	A	24"	18"	36"	111"	2	\$179.00
SHV0895	322	I	24"	18"	36"	111"	3	\$251.00
SHV0896	300	A	24"	18"	36"	111"	3	\$231.00
SHV0897	188	I	24"	18"	36"	75"	1A	\$150.00
SHV0898	169	A	24"	24"	36"	75"	1A	\$133.00
SHV0899	197	I	24"	24"	36"	75"	2	\$156.00
SHV0900	178	A	24"	24"	36"	75"	2	\$140.00

SHELVING

Ledge Shelving Nut & Bolt

LEDGE SHELVING UNITS

Stock No.	Weight (LBS)	Initial/ Additional	Width Depth	Abv Depth	Blw	Height	Class	Price
SHV0901	252	I	24"	24"	36"	75"	3	\$197.00
SHV0902	233	A	24"	24"	36"	75"	3	\$179.00
SHV0903	211	I	24"	24"	36"	87"	1A	\$163.00
SHV0904	189	A	24"	24"	36"	87"	1A	\$147.00
SHV0905	221	I	24"	24"	36"	87"	2	\$171.00
SHV0906	199	A	24"	24"	36"	87"	2	\$153.00
SHV0907	286	I	24"	24"	36"	87"	3	\$217.00
SHV0908	264	A	24"	24"	36"	87"	3	\$199.00
SHV0909	235	I	24"	24"	36"	99"	1A	\$181.00
SHV0910	211	A	24"	24"	36"	99"	1A	\$173.00
SHV0911	246	I	24"	24"	36"	99"	2	\$191.00

Stock No.	Weight (LBS)	Initial/ Additional	Width Depth	Abv Depth	Blw	Height	Class	Price
SHV0928	183	A	36"	12"	24"	87"	1A	\$143.00
SHV0929	212	I	36"	12"	24"	87"	2	\$165.00
SHV0930	199	A	36"	12"	24"	87"	2	\$153.00
SHV0931	252	I	36"	12"	24"	87"	3	\$191.00
SHV0932	239	A	36"	12"	24"	87"	3	\$179.00
SHV0933	217	I	36"	12"	24"	99"	1A	\$109.00
SHV0934	203	A	36"	12"	24"	99"	1A	\$156.00
SHV0935	235	I	36"	12"	24"	99"	2	\$180.00

56



ledge shelving, initial unit, and one additional unit

NOTE: Order an initial unit to be placed at the end of each row break of shelving units and additional units for all units within a row of shelving.

Stock No.	Weight (LBS)	Initial/ Additional	Width Depth	Abv Depth	Blw	Height	Class	Price
SHV0912	222	A	24"	24"	36"	99"	2	\$171.00
SHV0913	319	I	24"	24"	36"	99"	3	\$242.00
SHV0914	295	A	24"	24"	36"	99"	3	\$222.00
SHV0915	258	I	24"	24"	36"	111"	1A	\$199.00
SHV0916	231	A	24"	24"	36"	111"	1A	\$178.00
SHV0917	271	I	24"	24"	36"	111"	2	\$210.00
SHV0918	244	A	24"	24"	36"	111"	2	\$189.00
SHV0919	352	I	24"	24"	36"	111"	3	\$264.00
SHV0920	325	A	24"	24"	36"	111"	3	\$246.00
SHV0921	176	I	36"	12"	24"	75"	1A	\$141.00
SHV0922	165	A	36"	12"	24"	75"	1A	\$131.00
SHV0923	188	I	36"	12"	24"	75"	2	\$150.00
SHV0924	178	A	36"	12"	24"	75"	2	\$139.00
SHV0925	227	I	36"	12"	24"	75"	3	\$176.00
SHV0926	216	A	36"	12"	24"	75"	3	\$165.00
SHV0927	196	I	36"	12"	24"	87"	1A	\$154.00

Stock No.	Weight (LBS)	Int/ Additional	Width Depth	Abv Depth	Blw	Height	Class	Price
SHV0936	221	A	36"	12"	24"	99"	2	\$167.00
SHV0937	285	I	36"	12"	24"	99"	3	\$207.00
SHV0938	271	A	36"	12"	24"	99"	3	\$196.00
SHV0939	238	I	36"	12"	24"	111"	1A	\$186.00
SHV0940	223	A	36"	12"	24"	111"	1A	\$173.00
SHV0941	258	I	36"	12"	24"	111"	2	\$199.00
SHV0942	243	A	36"	12"	24"	111"	2	\$185.00
SHV0943	302	I	36"	12"	24"	111"	3	\$229.00
SHV0944	287	A	36"	12"	24"	111"	3	\$216.00
SHV0945	182	I	36"	15"	24"	75"	1A	\$145.00
SHV0946	170	A	36"	15"	24"	75"	1A	\$133.00
SHV0947	195	I	36"	15"	24"	75"	2	\$171.00
SHV0948	183	A	36"	15"	24"	75"	2	\$143.00
SHV0949	233	I	36"	15"	24"	75"	3	\$178.00
SHV0950	221	A	36"	15"	24"	75"	3	\$167.00
SHV0951	205	I	36"	15"	24"	87"	1A	\$160.00

LEDGE SHELVING UNITS

Stock No.	Weight (LBS)	Initial/ Additional	Width Depth	Abv Depth	Blw	Height	Class	Price
SHV0952	191	A	36"	15"	24"	87"	1A	\$146.00
SHV0953	220	I	36"	15"	24"	87"	2	\$171.00
SHV0954	206	A	36"	15"	24"	87"	2	\$158.00
SHV0955	261	I	36"	15"	24"	87"	3	\$197.00
SHV0956	247	A	36"	15"	24"	87"	3	\$187.00
SHV0957	228	I	36"	15"	24"	99"	1A	\$176.00
SHV0958	213	A	36"	15"	24"	99"	1A	\$163.00

Stock No.	Weight (LBS)	Initial/ Additional	Width Depth	Abv Depth	Blw	Height	Class	Price
SHV0974	269	A	36"	18"	30"	75"	3	\$200.00
SHV0975	233	I	36"	18"	30"	87"	1A	\$177.00
SHV0976	216	A	36"	18"	30"	87"	1A	\$164.00
SHV0977	247	I	36"	18"	30"	87"	2	\$187.00
SHV0978	230	A	36"	18"	30"	87"	2	\$173.00
SHV0979	313	I	36"	18"	30"	87"	3	\$238.00
SHV0980	296	A	36"	18"	30"	87"	3	\$224.00

1 Select a finish color.

2 Place 2-digit color code at end of stock no.

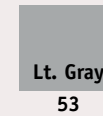
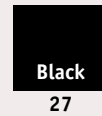
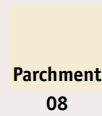

Additional colors may be available. Please call 202 305-3707 or 859 225-4824 for more information.

Stock No.	Weight (LBS)	Initial/ Additional	Width Depth	Abv Depth	Blw	Height	Class	Price
SHV0959	246	I	36"	15"	24"	99"	2	\$187.00
SHV0960	231	A	36"	15"	24"	99"	2	\$173.00
SHV0961	288	I	36"	15"	24"	99"	3	\$213.00
SHV0962	273	A	36"	15"	24"	99"	3	\$200.00
SHV0963	251	I	36"	15"	24"	111"	1A	\$196.00
SHV0964	234	A	36"	15"	24"	111"	1A	\$180.00
SHV0965	271	I	36"	15"	24"	111"	2	\$210.00
SHV0966	254	A	36"	15"	24"	111"	2	\$193.00
SHV0967	315	I	36"	15"	24"	111"	3	\$238.00
SHV0968	298	A	36"	15"	24"	111"	3	\$223.00
SHV0969	206	I	36"	18"	30"	75"	1A	\$161.00
SHV0970	191	A	36"	18"	30"	75"	1A	\$147.00
SHV0971	220	I	36"	18"	30"	75"	2	\$169.00
SHV0972	205	A	36"	18"	30"	75"	2	\$157.00
SHV0973	284	I	36"	18"	30"	75"	3	\$213.00

Stock No.	Weight (LBS)	Initial/ Additional	Width Depth	Abv Depth	Blw	Height	Class	Price
SHV0981	257	I	36"	18"	30"	99"	1A	\$194.00
SHV0982	238	A	36"	18"	30"	99"	1A	\$178.00
SHV0983	275	I	36"	18"	30"	99"	2	\$204.00
SHV0984	256	A	36"	18"	30"	99"	2	\$190.00
SHV0985	258	I	36"	18"	30"	99"	3	\$263.00
SHV0986	239	A	36"	18"	30"	99"	3	\$249.00
SHV0987	282	I	36"	18"	30"	111"	1A	\$217.00
SHV0988	262	A	36"	18"	30"	111"	1A	\$200.00
SHV0989	302	I	36"	18"	30"	111"	2	\$229.00
SHV0990	228	A	36"	18"	30"	111"	2	\$212.00
SHV0991	395	I	36"	18"	30"	111"	3	\$292.00
SHV0992	375	A	36"	18"	30"	111"	3	\$277.00
SHV0993	225	I	36"	18"	36"	75"	1A	\$169.00
SHV0994	208	A	36"	18"	36"	75"	1A	\$154.00
SHV0995	239	I	36"	18"	36"	75"	2	\$178.00

SHELVING

Ledge Shelving
Nut & Bolt**Ledge Shelving Units**

Ledge shelving has a smooth work surface. The ledge and the top and bottom shelves are fixed and the other shelves are adjustable on 1" centers. Additional units are the same as the initial unit without one partition or end panel. Widths range from 24" to 36" and the units are available in three load capacities. Comes in a variety of colors. See inside back cover for selection. Shelving accessories can be ordered for this shelving (see page 46).

NOTE: *Order an initial unit to be placed at the end of each row break of shelving units and additional units for all units within a row of shelving.*

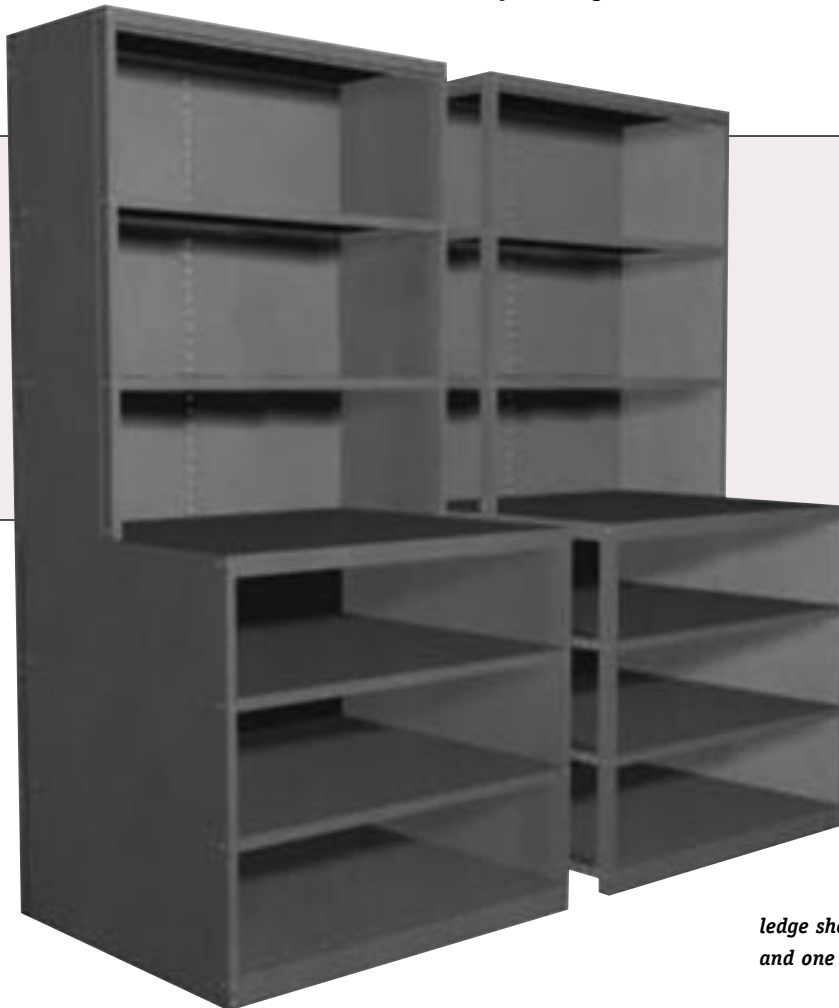

*ledge shelving, initial unit,
and one additional unit*

LEDGE SHELVING UNITS

Stock No.	Weight (LBS)	Initial/ Additional	Width Depth	Abv Depth	Blw	Height	Class	Price
SHV0996	221	A	36"	18"	36"	75"	2	\$163.00
SHV0997	305	I	36"	18"	36"	75"	3	\$223.00
SHV0998	288	A	36"	18"	36"	75"	3	\$210.00
SHV0999	250	I	36"	18"	36"	87"	1A	\$185.00
SHV1000	231	A	36"	18"	36"	87"	1A	\$171.00
SHV1001	266	I	36"	18"	36"	87"	2	\$196.00
SHV1002	247	A	36"	18"	36"	87"	2	\$179.00
SHV1003	343	I	36"	18"	36"	87"	3	\$249.00

Stock No.	Weight (LBS)	Initial/ Additional	Width Depth	Abv Depth	Blw	Height	Class	Price
SHV1018	221	A	36"	24"	36"	75"	1A	\$160.00
SHV1019	243	I	36"	24"	36"	75"	2	\$185.00
SHV1020	224	A	36"	24"	36"	75"	2	\$171.00
SHV1021	324	I	36"	24"	36"	75"	3	\$233.00
SHV1022	305	A	36"	24"	36"	75"	3	\$218.00
SHV1023	270	I	36"	24"	36"	87"	1A	\$193.00
SHV1024	248	A	36"	24"	36"	87"	1A	\$178.00
SHV1025	276	I	36"	24"	36"	87"	2	\$205.00

1 Select a finish color.

2 Place 2-digit color code at end of stock no.

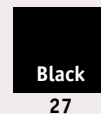
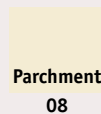

Additional colors may be available. Please call 202 305-3707 or 859 225-4824 for more information.

Stock No.	Weight (LBS)	Initial/ Additional	Width Depth	Abv Depth	Blw	Height	Class	Price
SHV1004	324	A	36"	18"	36"	87"	3	\$232.00
SHV1005	276	I	36"	18"	36"	99"	1A	\$203.00
SHV1006	256	A	36"	18"	36"	99"	1A	\$184.00
SHV1007	293	I	36"	18"	36"	99"	2	\$212.00
SHV1008	273	A	36"	18"	36"	99"	2	\$197.00
SHV1009	398	I	36"	18"	36"	99"	3	\$271.00
SHV1010	378	A	36"	18"	36"	99"	3	\$256.00
SHV1011	301	I	36"	18"	36"	111"	1A	\$224.00
SHV1012	276	A	36"	18"	36"	111"	1A	\$206.00
SHV1013	308	I	36"	18"	36"	111"	2	\$238.00
SHV1014	284	A	36"	18"	36"	111"	2	\$219.00
SHV1015	409	I	36"	18"	36"	111"	3	\$303.00
SHV1016	385	A	36"	18"	36"	111"	3	\$284.00
SHV1017	240	I	36"	24"	36"	75"	1A	\$177.00

Stock No.	Weight (LBS)	Initial/ Additional	Width Depth	Abv Depth	Blw	Height	Class	Price
SHV1026	254	A	36"	24"	36"	87"	2	\$190.00
SHV1027	366	I	36"	24"	36"	87"	3	\$259.00
SHV1028	344	A	36"	24"	36"	87"	3	\$243.00
SHV1029	300	I	36"	24"	36"	99"	1A	\$217.00
SHV1030	276	A	36"	24"	36"	99"	1A	\$197.00
SHV1031	308	I	36"	24"	36"	99"	2	\$226.00
SHV1032	284	A	36"	24"	36"	99"	2	\$208.00
SHV1033	409	I	36"	24"	36"	99"	3	\$290.00
SHV1034	385	A	36"	24"	36"	99"	3	\$270.00
SHV1035	330	I	36"	24"	36"	111"	1A	\$239.00
SHV1036	303	A	36"	24"	36"	111"	1A	\$218.00
SHV1037	339	I	36"	24"	36"	111"	2	\$251.00
SHV1038	312	A	36"	24"	36"	111"	2	\$231.00
SHV1039	452	I	36"	24"	36"	111"	3	\$322.00
SHV1040	425	A	36"	24"	36"	111"	3	\$301.00

SHELVING

Special Purpose Shelving



60

Light Industrial Shelving

The bigger the storage job, the better the reason to turn to UNICOR wide-span shelving — the answer for storing large, odd-sized, or bulky loads. Perfect for manual or automatic loading (except fork truck loading), these units come in a wide variety of sizes and shelf capacities, and snap together easily with no extra bracing required. Open on sides and back for maximum access.

E-Z-Lock Warehouse Shelving

These sturdy, wide-span warehouse storage units are available in a variety of sizes and configurations. Create the ideal shelving to fit your light duty storage needs. Whether you need medium, high density, or wide-span shelving, E-Z-Lock has something for you. You can do it yourself or let our experts measure, plan, and install.

Load Capacity

Standard duty unit (7' high) load capacity starts at 430 lbs. for a 48" x 24" size unit and progresses up to 900 lbs. for a 96" x 48" unit.

High-capacity bulk unit (7' high) load capacity starts at 700 lbs. for a 48" x 24" size unit and extends up to 1,330 lbs. for a 96" x 48" unit.

Load data are for static vertical loads in pounds and are based upon utilization of 5/8" particle board decking.

SHELVING

E-Z-Lock Shelving

E-Z-Lock Standard Units

Using E-Z-Lock's snap-together assembly, standard units provide sturdy, organized shelving at an affordable price. A variety of sizes and capacities offers versatile light and medium-duty storage in commercial and industrial applications. Shelves are easily adjusted in 2" increments to accommodate nearly any

size load. When extra capacity is needed, upgrade to **E-Z-Lock high-capacity bulk shelving units**. Shelves can carry up to two-and-one-half times the shelf load of regular bulk units. Extra shelves can be added to high-capacity bulk units for additional storage area and capacity. (Actual decking is not included.) Recommend 3/8" particle board or 1/2" marine plywood.



E-Z-LOCK STANDARD UNITS

Dim. (W/D/H)	Without Decking Board						With Particle Board					
	Stock No.	Starter LBS.	Price	Stock No.	Add-On LBS.	Price	Stock No.	Starter LBS.	Price	Stock No.	Add-On LBS.	Price
4-SHELF UNITS												
36" x 12" x 84"	US2100 □□	41	\$82.50	US2101 □□	36	\$67.35	US2100PB □□	70	\$104.50	US2101PB □□	65	\$90.20
36" x 18" x 84"	US2102 □□	44	\$87.00	US2103 □□	38	\$69.60	US2102PB □□	88	\$124.30	US2103PB □□	82	\$106.70

62

1 — Select a finish color.

2 — Place 2-digit color code at end of stock no.



Additional colors may be available. Please call 202 305-3707 or 859 225-4824 for more information.

NOTE: See capacity chart on page 61.

Dim. (W/D/H)	Without Decking Board						With Particle Board					
	Stock No.	Starter LBS.	Price	Stock No.	Add-On LBS.	Price	Stock No.	Starter LBS.	Price	Stock No.	Add-On LBS.	Price
4-SHELF UNITS												
36" x 24" x 84"	US2104 □□	48	\$90.60	US2105 □□	39	\$71.40	US2104PB □□	106	\$136.40	US2105PB □□	97	\$117.70
48" x 12" x 84"	US2106 □□	47	\$91.50	US2107 □□	42	\$76.35	US2106PB □□	86	\$114.40	US2107PB □□	81	\$99.00
48" x 18" x 84"	US2108 □□	51	\$96.00	US2109 □□	44	\$78.60	US2108PB □□	109	\$133.10	US2109PB □□	102	\$115.50
48" x 24" x 84"	US2110 □□	54	\$99.60	US2111 □□	45	\$80.40	US2110PB □□	131	\$146.30	US2111PB □□	122	\$126.50
5-SHELF UNITS												
36" x 12" x 84"	US2112 □□	44	\$88.10	US2113 □□	39	\$72.95	US2112PB □□	80	\$116.60	US2113PB □□	75	\$101.20
36" x 18" x 84"	US2114 □□	47	\$92.60	US2115 □□	41	\$75.20	US2114PB □□	101	\$138.60	US2115PB □□	95	\$122.10
36" x 24" x 84"	US2116 □□	50	\$96.20	US2117 □□	42	\$77.00	US2116PB □□	122	\$154.00	US2117PB □□	114	\$135.30
48" x 12" x 84"	US2118 □□	52	\$99.10	US2119 □□	46	\$83.95	US2118PB □□	100	\$127.60	US2119PB □□	94	\$112.20
48" x 18" x 84"	US2120 □□	55	\$103.60	US2121 □□	48	\$86.20	US2120PB □□	127	\$149.60	US2121PB □□	120	\$133.10
48" x 24" x 84"	US2122 □□	58	\$107.20	US2123 □□	49	\$88.00	US2122PB □□	154	\$165.00	US2123PB □□	145	\$146.30

Dim. (W/D/H)	Stock No.	Without Decking Board					With Particle Board					
		Starter		Price	Add-On		Starter		Price	Add-On		
		LBS.	Stock No.		LBS.	Price	Stock No.	LBS.		Price	Stock No.	LBS.
6-SHELF UNITS												
36" x 12" x 84"	US2124 □□	47	\$93.70	US2125 □□	42	\$78.55	US2124PB □□	91	\$127.60	US2125PB □□	86	\$113.30
36" x 18" x 84"	US2126 □□	50	\$98.20	US2127 □□	44	\$80.80	US2126PB □□	115	\$154.00	US2127PB □□	109	\$136.40
36" x 24" x 84"	US2128 □□	53	\$101.80	US2129 □□	45	\$82.60	US2128PB □□	140	\$171.60	US2129PB □□	132	\$152.90
48" x 12" x 84"	US2130 □□	56	\$106.70	US2131 □□	50	\$91.55	US2130PB □□	114	\$140.80	US2131PB □□	100	\$126.50
48" x 18" x 84"	US2132 □□	59	\$111.20	US2133 □□	52	\$93.80	US2132PB □□	146	\$167.20	US2133PB □□	139	\$147.60
48" x 24" x 84"	US2134 □□	62	\$114.80	US2135 □□	53	\$95.60	US2134PB □□	178	\$181.50	US2135PB □□	169	\$166.10
7-SHELF UNITS												
36" x 12" x 84"	US2136 □□	50	\$99.30	US2137 □□	45	\$84.15	US2136PB □□	101	\$139.70	US2137PB □□	96	\$124.30
36" x 18" x 84"	US2138 □□	53	\$103.80	US2139 □□	47	\$86.40	US2138PB □□	129	\$169.40	US2139PB □□	123	\$151.80
36" x 24" x 84"	US2140 □□	56	\$107.40	US2141 □□	48	\$88.20	US2140PB □□	157	\$189.20	US2141PB □□	149	\$170.50
48" x 12" x 84"	US2142 □□	60	\$114.30	US2143 □□	54	\$99.15	US2142PB □□	128	\$154.00	US2143PB □□	122	\$139.70
48" x 18" x 84"	US2144 □□	63	\$118.80	US2145 □□	56	\$101.40	US2144PB □□	164	\$183.70	US2145PB □□	157	\$167.20
48" x 24" x 84"	US2146 □□	66	\$122.40	US2147 □□	57	\$103.20	US2146PB □□	201	\$204.60	US2147PB □□	192	\$185.90

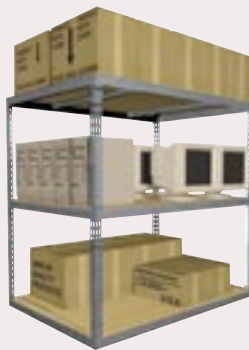

E-Z-Lock Bulk Storage Units

E-Z-Lock bulk storage units have greater shelf areas than standard units, making them ideal for storing large or odd-sized items. The wide range of shelf sizes and capacities combined with the option of adding extra shelves allow you to design the bulk shelving system that best accommodates your needs.

E-Z-LOCK BULK STORAGE UNITS

Dim. (W/D/H)	Stock No.	Without Decking Board					With Particle Board					
		Starter		Price	Add-On		Starter		Price	Add-On		
		LBS.	Stock No.		LBS.	Price	Stock No.	LBS.		Price	Stock No.	LBS.
3-SHELF UNITS												
48" x 18" x 84"	US2200 □□	53	\$108.30	US2201 □□	51	\$100.80	US2200PB □□	97	\$135.30	US2201PB □□	95	\$127.60
48" x 24" x 84"	US2202 □□	57	\$113.70	US2203 □□	55	\$106.20	US2202PB □□	115	\$147.40	US2203PB □□	113	\$139.70
48" x 36" x 84"	US2204 □□	70	\$131.40	US2205 □□	68	\$123.90	US2204PB □□	157	\$182.30	US2205PB □□	155	\$167.50
48" x 48" x 84"	US2206 □□	80	\$144.45	US2207 □□	77	\$136.95	US2206PB □□	187	\$214.50	US2207PB □□	184	\$206.80
60" x 18" x 84"	US2208 □□	59	\$120.90	US2209 □□	57	\$113.40	US2208PB □□	113	\$191.40	US2209PB □□	111	\$183.70
60" x 24" x 84"	US2210 □□	67	\$131.10	US2211 □□	64	\$123.60	US2210PB □□	139	\$201.30	US2211PB □□	136	\$193.60
60" x 36" x 84"	US2212 □□	76	\$144.00	US2213 □□	74	\$136.50	US2212PB □□	184	\$259.40	US2213PB □□	182	\$252.70
60" x 48" x 84"	US2214 □□	86	\$157.05	US2215 □□	83	\$149.55	US2214PB □□	195	\$299.20	US2215PB □□	193	\$291.50

SHELVING

E-Z-Lock Shelving

E-Z-LOCK BULK STORAGE UNITS

Dim. (W/D/H)	Without Decking Board			With Particle Board			Without Decking Board			With Particle Board		
	Stock No.	Starter LBS.	Price	Stock No.	Add-On LBS.	Price	Stock No.	Starter LBS.	Price	Stock No.	Add-On LBS.	Price
3-SHELF UNITS												
72" x 18" x 84"	US2216 □□	68	\$138.45	US2217 □□	66	\$130.95	US2216PB □□	133	\$209.00	US2217PB □□	131	\$201.30
72" x 24" x 84"	US2218 □□	73	\$143.40	US2219 □□	71	\$135.90	US2218PB □□	160	\$213.40	US2219PB □□	158	\$205.70
72" x 36" x 84"	US2220 □□	83	\$156.30	US2221 □□	80	\$148.80	US2220PB □□	213	\$294.80	US2221PB □□	210	\$287.10
72" x 48" x 84"	US2222 □□	92	\$169.35	US2223 □□	90	\$161.85	US2222PB □□	265	\$311.30	US2223PB □□	263	\$303.60
96" x 18" x 84"	US2224 □□	86	\$178.20	US2225 □□	84	\$170.70	US2224PB □□	173	\$247.50	US2225PB □□	171	\$239.80
96" x 24" x 84"	US2226 □□	93	\$184.50	US2227 □□	90	\$177.00	US2226PB □□	209	\$254.10	US2227PB □□	206	\$246.40
96" x 36" x 84"	US2228 □□	105	\$201.00	US2229 □□	103	\$193.50	US2228PB □□	278	\$342.10	US2229PB □□	276	\$335.50
96" x 48" x 84"	US2230 □□	118	\$219.60	US2231 □□	116	\$212.10	US2230PB □□	349	\$288.20	US2231PB □□	347	\$291.50

64

1 — Select a finish color.

2 — Place 2-digit color code at end of stock no.

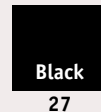
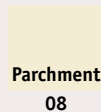

Additional colors may be available. Please call 202 305-3707 or 859 225-4824 for more information.

Dim. (W/D/H)	Without Decking Board			With Particle Board			Without Decking Board			With Particle Board		
	Stock No.	Starter LBS.	Price	Stock No.	Add-On LBS.	Price	Stock No.	Starter LBS.	Price	Stock No.	Add-On LBS.	Price
4-SHELF UNITS												
48" x 18" x 84"	US2500 □□	65	\$133.00	US2501 □□	62	\$125.50	US2500PB □□	123	\$169.40	US2501PB □□	120	\$161.70
48" x 24" x 84"	US2502 □□	70	\$140.20	US2503 □□	68	\$132.70	US2502PB □□	147	\$185.90	US2503PB □□	145	\$162.80
48" x 36" x 84"	US2504 □□	88	\$163.80	US2505 □□	85	\$156.30	US2504PB □□	204	\$180.90	US2505PB □□	201	\$178.90
48" x 48" x 84"	US2506 □□	100	\$181.20	US2507 □□	98	\$173.70	US2506PB □□	242	\$275.00	US2507PB □□	240	\$267.30
60" x 18" x 84"	US2508 □□	73	\$149.80	US2509 □□	71	\$142.30	US2508PB □□	145	\$244.20	US2509PB □□	143	\$236.50
60" x 24" x 84"	US2510 □□	83	\$163.40	US2511 □□	81	\$155.90	US2510PB □□	179	\$257.40	US2511PB □□	177	\$249.70
60" x 36" x 84"	US2512 □□	96	\$180.60	US2513 □□	94	\$173.10	US2512PB □□	240	\$273.60	US2513PB □□	238	\$269.40
60" x 48" x 84"	US2514 □□	109	\$198.00	US2515 □□	106	\$190.50	US2514PB □□	301	\$388.30	US2515PB □□	298	\$380.60
72" x 18" x 84"	US2516 □□	85	\$173.20	US2517 □□	83	\$165.70	US2516PB □□	172	\$267.30	US2517PB □□	170	\$259.60
72" x 24" x 84"	US2518 □□	92	\$179.80	US2519 □□	89	\$172.30	US2518PB □□	200	\$273.40	US2519PB □□	205	\$266.20
72" x 36" x 84"	US2520 □□	104	\$197.00	US2521 □□	102	\$189.50	US2520PB □□	277	\$382.80	US2521PB □□	275	\$375.10

E-Z-LOCK BULK STORAGE UNITS

Dim. (W/D/H)	Without Decking Board						With Particle Board					
	Stock No.	Starter LBS.	Price	Stock No.	Add-On LBS.	Price	Stock No.	Starter LBS.	Price	Stock No.	Add-On LBS.	Price
4-SHELF UNITS												
72" x 48" x 84"	US2522	117	\$214.40	US2523	114	\$206.90	US2522PB	348	\$404.80	US2523PB	345	\$397.10
96" x 18" x 84"	US2524	109	\$226.20	US2525	107	\$218.70	US2524PB	225	\$319.00	US2525PB	223	\$311.30
96" x 24" x 84"	US2526	118	\$234.60	US2527	115	\$227.10	US2526PB	272	\$327.80	US2527PB	269	\$320.10
96" x 36" x 84"	US2528	135	\$256.60	US2529	132	\$249.10	US2528PB	366	\$445.50	US2529PB	363	\$437.80
96" x 48" x 84"	US2530	152	\$281.40	US2531	149	\$273.90	US2530PB	460	\$484.00	US2531PB	457	\$476.30



E-Z-Lock Archive Storage Units

E-Z-Lock archive storage units provide high density storage of standard 12" x 15" x 10" document boxes. Units hold 20 boxes per shelf.

Archive storage units with angle track deck system are also available. For further information, please call 202 305-3707, 859 225-4824, or 405 262-4875 ext. 391.

E-Z-LOCK ARCHIVE STORAGE UNITS

Dim. (W/D/H)	Starter			Add-On		
	Stock No.	LBS.	Price	Stock No.	LBS.	Price
69" x 30" x 84"	US2300	107	\$214.20	US2301	105	\$206.70
69" x 30" x 168"	US2304	206	\$432.80	US2305	195	\$390.20
69" x 30" x 192"	US2306	236	\$494.80	US2307	223	\$445.90

INDUSTRIAL RACKING



66

Types of Industrial Racking

Pallet Racking

This style provides convenient, heavy-duty storage of palletized items.

Stacking Racks

Made for forklift handling, stacking racks provide instant pallet storage when you need it, and they nest together completely when you don't.

Internet Orders:

www.unicor.gov

UNICOR's industrial storage products are strong and durable, designed with flexibility, and meet the engineered weight specification for application. Customers can create configurations or we will design a system to meet your needs. Our systems are complete. We offer services from the first step to turnkey projects, including installation. For additional information, call 202 305-3707, 859 225-4824, or 405 262-4875 ext. 391.



Catwalks and Mezzanines

Turn empty ceiling space into functional space for storage, work, or service.

Cantilever Racking

Designed for continuous, barrier-free horizontal storage of heavy items, such as lumber and furniture.

INDUSTRIAL RACKING

Industrial Pallet Racking

BEAM CAPACITY

12-Gauge Measurement

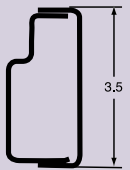
	Span	Storage Capacity Per Pair (LBS)	Weight (LBS)
	4'	8,707	23.5
	4.5'	7,739	26
	5'	6,965	28.5
	6'	5,805	33.5
	7'	4,975	39
	8'	4,353	44
	9'	3,870	49
	10'	3,483	54
	12'	2,902	64.5
	14'	2,488	74.5
16'	2,056	85	

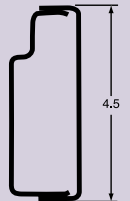
	4'	12,777	26.5
	4.5'	11,358	29.5
	5'	10,222	32.5
	6'	8,518	38.5
	7'	7,301	44.5
	8'	6,389	50.5
	9'	5,679	56
	10'	5,111	62
	12'	4,259	74
	14'	3,651	85.5
16'	3,194	97.5	

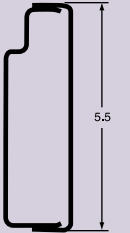
	4'	17,414	29.5
	4.5'	15,479	32.5
	5'	13,931	36
	6'	11,609	42.5
	7'	9,951	49
	8'	8,707	56
	9'	7,739	62.5
	10'	6,965	69
	12'	5,805	82
	14'	4,975	95.5
16'	4,353	108.5	

14 Gauge - Measurement

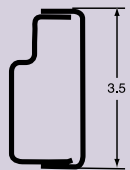
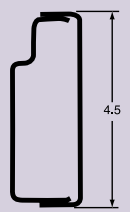
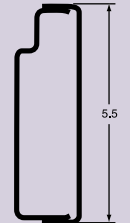
	4'	6,518	18
	4.5'	5,794	19.5
	5'	5,215	21.5
	6'	4,345	25
	7'	3,725	29
	8'	3,259	32.5
	9'	2,897	36
	10'	2,607	40
	12'	2,173	47.5
	14'	1,862	54.5
	16'	1,539	62
	4'	9,477	20
	4.5'	8,424	22
	5'	7,582	24
	6'	6,318	28.5
	7'	5,416	32.5
	8'	4,739	37
	9'	4,212	41
	10'	3,791	45
	12'	3,159	53.5
	14'	2,708	62
	16'	2,369	70.5
	4'	12,845	22
	4.5'	11,418	24.5
5'	10,276	27	
6'	8,564	31.5	
7'	7,340	36.5	
8'	6,423	41	
9'	5,709	46	
10'	5,138	50.5	
12'	4,282	60	
14'	3,670	69.5	
16'	3,211	79	

Industrial shelf beam capacity specifications are listed to the left, with the shipping weight. Beam products are listed below with stock numbers and descriptions.

BEAMS

Stock No.	Description	Dim. (W/L)	Price
PRKBM12103 □□	Beam, Shelf, 12GA	3.5" x 10.0'	\$37.00
PRKBM12103 □□	Beam, Shelf, 12GA	3.5" x 10.0'	\$37.00
PRKBM12103 □□	Beam, Shelf, 12GA	3.5" x 10.0'	\$37.00
PRKBM12103 □□	Beam, Shelf, 12GA	3.5" x 10.0'	\$37.00
PRKBM12103 □□	Beam, Shelf, 12GA	3.5" x 10.0'	\$37.00
PRKBM12103 □□	Beam, Shelf, 12GA	3.5" x 10.0'	\$37.00
PRKBM12103 □□	Beam, Shelf, 12GA	3.5" x 10.0'	\$37.00
PRKBM12103 □□	Beam, Shelf, 12GA	3.5" x 10.0'	\$37.00
PRKBM12103 □□	Beam, Shelf, 12GA	3.5" x 10.0'	\$37.00

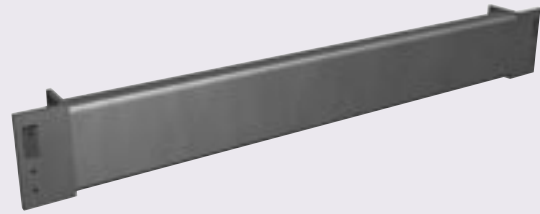

Stock No.	Description	Dim. (W/L)	Price
PRKBM12104 □□	Beam, Shelf, 12GA	4.5" x 10.0'	\$40.00
PRKBM12105 □□	Beam, Shelf, 12GA	5.5" x 10.0'	\$43.00
PRKBM12123 □□	Beam, Shelf, 12GA	3.5" x 12.0'	\$40.00
PRKBM12124 □□	Beam, Shelf, 12GA	4.5" x 12.0'	\$45.00
PRKBM12125 □□	Beam, Shelf, 12GA	5.5" x 12.0'	\$47.00
PRKBM12135 □□	Beam, Shelf, 12GA	5.5" x 13.0'	\$48.00
PRKBM12143 □□	Beam, Shelf, 12GA	3.5" x 14.0'	\$44.00
PRKBM12144 □□	Beam, Shelf, 12GA	4.5" x 14.0'	\$49.00
PRKBM12145 □□	Beam, Shelf, 12GA	5.5" x 14.0'	\$52.00
PRKBM12163 □□	Beam, Shelf, 12GA	3.5" x 16.0'	\$48.00
PRKBM12164 □□	Beam, Shelf, 12GA	4.5" x 16.0'	\$53.00
PRKBM12165 □□	Beam, Shelf, 12GA	5.5" x 16.0'	\$56.00
PRKBM1243 □□	Beam, Shelf, 12GA	3.5" x 4.0'	\$23.00
PRKBM1244 □□	Beam, Shelf, 12GA	4.5" x 4.0'	\$25.00
PRKBM1245 □□	Beam, Shelf, 12GA	5.5" x 4.0'	\$28.00
PRKBM12453 □□	Beam, Shelf, 12GA	3.5" x 4.5'	\$24.00

Stock No.	Description	Dim. (W/L)	Price
PRKBM12454 □□	Beam, Shelf, 12GA	4.5' x 4.5'	\$26.00
PRKBM12455 □□	Beam, Shelf, 12GA	5.5' x 4.5'	\$29.00
PRKBM1253 □□	Beam, Shelf, 12GA	3.5' x 5.0'	\$26.00
PRKBM1254 □□	Beam, Shelf, 12GA	4.5' x 5.0'	\$29.00
PRKBM1255 □□	Beam, Shelf, 12GA	5.5' x 5.0'	\$30.00
PRKBM1263 □□	Beam, Shelf, 12GA	3.5' x 6.0'	\$29.00
PRKBM1264 □□	Beam, Shelf, 12GA	4.5' x 6.0'	\$31.00
PRKBM1265 □□	Beam, Shelf, 12GA	5.5' x 6.0'	\$32.00
PRKBM1273 □□	Beam, Shelf, 12GA	3.5' x 7.0'	\$31.00
PRKBM1274 □□	Beam, Shelf, 12GA	4.5' x 7.0'	\$33.00
PRKBM1275 □□	Beam, Shelf, 12GA	5.5' x 7.0'	\$36.00
PRKBM1283 □□	Beam, Shelf, 12GA	3.5' x 8.0'	\$32.00
PRKBM1284 □□	Beam, Shelf, 12GA	4.5' x 8.0'	\$36.00
PRKBM1285 □□	Beam, Shelf, 12GA	5.5' x 8.0'	\$38.00

Stock No.	Description	Dim. (W/L)	Price
PRKBM14143 □□	Beam, Shelf, 14GA	3.5' x 14.0'	\$39.00
PRKBM14144 □□	Beam, Shelf, 14GA	4.5' x 14.0'	\$43.00
PRKBM14145 □□	Beam, Shelf, 14GA	5.5' x 14.0'	\$46.00
PRKBM14153 □□	Beam, Shelf, 14GA	3.5' x 15.0'	\$37.00
PRKBM14163 □□	Beam, Shelf, 14GA	3.5' x 16.0'	\$43.00
PRKBM14164 □□	Beam, Shelf, 14GA	4.5' x 16.0'	\$46.00
PRKBM14165 □□	Beam, Shelf, 14GA	5.5' x 16.0'	\$49.00
PRKBM1443 □□	Beam, Shelf, 14GA	3.5' x 4.0'	\$21.00
PRKBM1444 □□	Beam, Shelf, 14GA	4.5' x 4.0'	\$23.00
PRKBM1445 □□	Beam, Shelf, 14GA	5.5' x 4.0'	\$25.00
PRKBM14453 □□	Beam, Shelf, 14GA	3.5' x 4.5'	\$22.00
PRKBM14454 □□	Beam, Shelf, 14GA	4.5' x 4.5'	\$24.00
PRKBM14455 □□	Beam, Shelf, 14GA	5.5' x 4.5'	\$26.00
PRKBM1453 □□	Beam, Shelf, 14GA	3.5' x 5.0'	\$24.00

1 — Select a finish color.

2 — Place 2-digit color code at end of stock no.

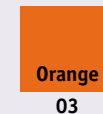
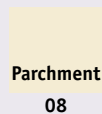

Additional colors may be available. Please call 202 305-3707 or 859 225-4824 for more information.

Stock No.	Description	Dim. (W/L)	Price
PRKBM12854 □□	Beam, Shelf, 12GA	4.5' x 8.5'	\$32.00
PRKBM12855 □□	Beam, Shelf, 12GA	5.5' x 8.5'	\$41.50
PRKBM1293 □□	Beam, Shelf, 12GA	3.5' x 9.0'	\$35.00
PRKBM1294 □□	Beam, Shelf, 12GA	4.5' x 9.0'	\$38.00
PRKBM1295 □□	Beam, Shelf, 12GA	5.5' x 9.0'	\$40.00
PRKBM14103 □□	Beam, Shelf, 14GA	3.5' x 10.0'	\$33.00
PRKBM14104 □□	Beam, Shelf, 14GA	4.5' x 10.0'	\$36.00
PRKBM14105 □□	Beam, Shelf, 14GA	5.5' x 10.0'	\$38.00
PRKBM141054 □□	Beam, Shelf, 14GA	4.5' x 10.5'	\$40.00
PRKBM141055 □□	Beam, Shelf, 14GA	5.5' x 10.5'	\$45.00
PRKBM14115 □□	Beam, Shelf, 14GA	5.5' x 11.0'	\$39.00
PRKBM14123 □□	Beam, Shelf, 14GA	3.5' x 12.0'	\$37.00
PRKBM14124 □□	Beam, Shelf, 14GA	4.5' x 12.0'	\$39.00
PRKBM14125 □□	Beam, Shelf, 14GA	5.5' x 12.0'	\$41.00

Stock No.	Description	Dim. (W/L)	Price
PRKBM1454 □□	Beam, Shelf, 14GA	4.5' x 5.0'	\$26.00
PRKBM1455 □□	Beam, Shelf, 14GA	5.5' x 5.0'	\$29.00
PRKBM1463 □□	Beam, Shelf, 14GA	3.5' x 6.0'	\$26.00
PRKBM1464 □□	Beam, Shelf, 14GA	4.5' x 6.0'	\$28.00
PRKBM1465 □□	Beam, Shelf, 14GA	5.5' x 6.0'	\$30.00
PRKBM1473 □□	Beam, Shelf, 14GA	3.5' x 7.0'	\$29.00
PRKBM1474 □□	Beam, Shelf, 14GA	4.5' x 7.0'	\$30.00
PRKBM1475 □□	Beam, Shelf, 14GA	5.5' x 7.0'	\$32.00
PRKBM1483 □□	Beam, Shelf, 14GA	3.5' x 8.0'	\$30.00
PRKBM1484 □□	Beam, Shelf, 14GA	4.5' x 8.0'	\$32.00
PRKBM1485 □□	Beam, Shelf, 14GA	5.5' x 8.0'	\$35.00
PRKBM1493 □□	Beam, Shelf, 14GA	3.5' x 9.0'	\$32.00
PRKBM1494 □□	Beam, Shelf, 14GA	4.5' x 9.0'	\$33.00
PRKBM1495 □□	Beam, Shelf, 14GA	5.5' x 9.0'	\$36.00
PRKBM14954 □□	Beam, Shelf, 14GA	4.5' x 9.5'	\$30.00

INDUSTRIAL RACKING

Industrial Pallet Racking

Crossbars

Crossbars assist with pallet loading and prevent beam spread. Heavy duty crossbars are 3" wide and are used in conjunction with standard pallets. A minimum of two crossbars is recommended for every pallet load applied. A 90-degree flange prevents slipping, ensures pallets loading, and prevents accidental beam spreading.

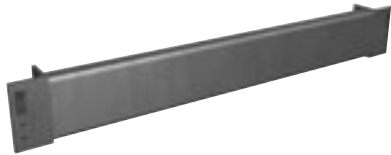

Size	Gauge	Weight
24"	12	5 lbs.
40"	12	8 lbs.
42"	12	9 lbs.
48"	12	10 lbs.

70

1 Select a finish color.

2 Place 2-digit color code at end of stock no.

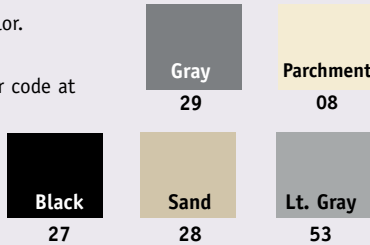

Additional colors may be available. Please call 202 305-3707 or 859 225-4824 for more information.

CROSSBARS

Stock No.	Description	Length	Price
PRKCB24 □□	Crossbar, Hvy-Duty, Flanged 12GA	24"	\$6.80
PRKCB30 □□	Crossbar, Hvy-Duty, Flanged, 12GA	30"	\$7.00
PRKCB36 □□	Crossbar, Hvy-Duty, Flanged, 12GA	36"	\$8.00
PRKCB40 □□	Crossbar, Hvy-Duty, Flanged, 12GA	40"	\$8.30
PRKCB42 □□	Crossbar, Hvy-Duty, Flanged, 12GA	42"	\$8.75
PRKCB48 □□	Crossbar, Hvy-Duty, Flanged, 12GA	48"	\$9.25
PRKCB54 □□	Crossbar, Hvy-Duty, Flanged, 12GA	54"	\$10.00

Storage Capacity

Ht.	Gauge	Depth	Free Standing	Weight (LBS)
4'	12	36"	46,200	49
4'	12	40"	46,200	50
4'	12	42"	46,200	59
4'	12	48"	46,200	66
4'	14	36"	32,000	40
4'	14	40"	32,000	42
4'	14	42"	32,000	53
4'	14	48"	32,400	66
6'	12	36"	46,200	63
6'	12	40"	46,200	64
6'	12	42"	46,200	65
6'	12	48"	46,200	66
6'	14	36"	32,400	46
6'	14	40"	32,400	46
6'	14	42"	32,400	47
6'	14	48"	32,400	47
8'	12	36"	39,200	87
8'	12	40"	39,200	88
8'	12	42"	39,200	88
8'	12	48"	39,200	88
8'	14	36"	29,200	62
8'	14	40"	29,200	62
8'	14	42"	29,200	63
8'	14	48"	29,200	64
9'	12	36"	36,400	96
9'	12	40"	36,400	96
9'	12	42"	36,400	97
9'	12	48"	36,400	101
9'	14	36"	26,900	69
9'	14	40"	26,900	70
9'	14	42"	26,900	71
9'	14	48"	26,900	72
10'	12	36"	33,400	100
10'	12	40"	33,400	101
10'	12	42"	33,400	102
10'	12	48"	33,400	103
10'	14	36"	24,600	75
10'	14	40"	24,600	75
10'	14	42"	24,600	76
10'	14	48"	24,600	77
12'	12	36"	25,600	127
12'	12	40"	25,600	128
12'	12	42"	25,600	129
12'	12	48"	25,600	130
12'	14	36"	20,200	91
12'	14	40"	29,200	91
12'	14	42"	20,200	92
12'	14	48"	20,200	93
14'	12	36"	19,400	145
14'	12	40"	19,400	146
14'	12	42"	19,400	148
14'	12	48"	19,400	150
14'	14	36"	18,200	105
14'	14	42"	18,200	107
14'	14	48"	18,200	108

UPRIGHT FRAMES

Stock No.	Description	Dim. (D/H)	Price
PRKUP121030 □□	Frame, Upright, 12GA	30" x 10'	\$85.00
PRKUP121030 □□	Frame, Upright, 12GA	30" x 10'	\$85.00
PRKUP121030 □□	Frame, Upright, 12GA	30" x 10'	\$85.00
PRKUP121030 □□	Frame, Upright, 12GA	30" x 10'	\$85.00
PRKUP121030 □□	Frame, Upright, 12GA	30" x 10'	\$85.00
PRKUP121030 □□	Frame, Upright, 12GA	30" x 10'	\$85.00
PRKUP121030 □□	Frame, Upright, 12GA	30" x 10'	\$85.00
PRKUP121030 □□	Frame, Upright, 12GA	30" x 10'	\$85.00
PRKUP121030 □□	Frame, Upright, 12GA	30" x 10'	\$85.00
PRKUP121036 □□	Frame, Upright, 12GA	36" x 10'	\$71.00
PRKUP121040 □□	Frame, Upright, 12GA	40" x 10'	\$72.00
PRKUP121042 □□	Frame, Upright, 12GA	42" x 10'	\$74.00
PRKUP121048 □□	Frame, Upright, 12GA	48" x 10'	\$76.00

Stock No.	Description	Dim. (D/H)	Price
PRKUP121540 □□	Frame, Upright, 12GA	40" x 15'	\$108.00
PRKUP121542 □□	Frame, Upright, 12GA	42" x 15'	\$109.00
PRKUP121548 □□	Frame, Upright, 12GA	48" x 15'	\$110.00
PRKUP121636 □□	Frame, Upright, 12GA	36" x 16'	\$112.00
PRKUP121640 □□	Frame, Upright, 12GA	40" x 16'	\$113.00
PRKUP121642 □□	Frame, Upright, 12GA	42" x 16'	\$114.00
PRKUP121648 □□	Frame, Upright, 12GA	48" x 16'	\$116.00
PRKUP121740 □□	Frame, Upright, 12GA	40" x 17'	\$117.00
PRKUP121824 □□	Frame, Upright, 12GA	24" x 18'	\$98.00
PRKUP121830 □□	Frame, Upright, 12GA	30" x 18'	\$105.00
PRKUP121836 □□	Frame, Upright, 12GA	36" x 18'	\$129.00
PRKUP121840 □□	Frame, Upright, 12GA	40" x 18'	\$130.00
PRKUP121842 □□	Frame, Upright, 12GA	42" x 18'	\$131.00

Upright Frames →
UNICOR pallet rack upright frames are made from 12- and 14-gauge thick steel in a wide selection of heights. Create an endless variety of configuration and capacity requirements.



Stock No.	Description	Dim. (D/H)	Price
PRKUP121230 □□	Frame, Upright, 12GA	30" x 12'	\$93.00
PRKUP121236 □□	Frame, Upright, 12GA	36" x 12'	\$86.00
PRKUP121240 □□	Frame, Upright, 12GA	40" x 12'	\$87.40
PRKUP121242 □□	Frame, Upright, 12GA	42" x 12'	\$88.00
PRKUP121248 □□	Frame, Upright, 12GA	48" x 12'	\$90.00
PRKUP121330 □□	Frame, Upright, 12GA	30" x 13'	\$102.00
PRKUP121430 □□	Frame, Upright, 12GA	30" x 14'	\$98.66
PRKUP121436 □□	Frame, Upright, 12GA	36" x 14'	\$100.00
PRKUP121440 □□	Frame, Upright, 12GA	40" x 14'	\$101.50
PRKUP121442 □□	Frame, Upright, 12GA	42" x 14'	\$102.50
PRKUP121448 □□	Frame, Upright, 12GA	48" x 14'	\$103.69
PRKUP121524 □□	Frame, Upright, 12GA	24" x 15'	\$106.00
PRKUP121536 □□	Frame, Upright, 12GA	36" x 15'	\$107.00

Stock No.	Description	Dim. (D/H)	Price
PRKUP121848 □□	Frame, Upright, 12GA	48" x 18'	\$133.00
PRKUP122040 □□	Frame, Upright, 12GA	40" x 20'	\$135.00
PRKUP122042 □□	Frame, Upright, 12GA	42" x 20'	\$135.00
PRKUP122048 □□	Frame, Upright, 12GA	48" x 20'	\$138.00
PRKUP122140 □□	Frame, Upright, 12GA	40" x 21'	\$137.00
PRKUP122142 □□	Frame, Upright, 12GA	42" x 21'	\$140.00
PRKUP122240 □□	Frame, Upright, 12GA	40" x 22'	\$139.00
PRKUP122340 □□	Frame, Upright, 12GA	40" x 23'	\$141.00
PRKUP122440 □□	Frame, Upright, 12GA	40" x 24'	\$153.00
PRKUP122540 □□	Frame, Upright, 12GA	40" x 25'	\$160.00
PRKUP12436 □□	Frame, Upright, 12GA	36" x 4'	\$47.00
PRKUP12440 □□	Frame, Upright, 12GA	40" x 4'	\$48.00
PRKUP12442 □□	Frame, Upright, 12GA	42" x 4'	\$49.00

INDUSTRIAL RACKING

Industrial Pallet Racking

Stock No.	Description	Dim. (D/H)	Price
PRKUP12448 □□	Frame, Upright, 12GA	48' x 4'	\$50.00
PRKUP12536 □□	Frame, Upright, 12GA	36' x 5'	\$51.00
PRKUP12548 □□	Frame, Upright, 12GA	48' x 5'	\$52.00
PRKUP12624 □□	Frame, Upright, 12GA	24' x 6'	\$53.00
PRKUP12636 □□	Frame, Upright, 12GA	36' x 6'	\$53.00
PRKUP12640 □□	Frame, Upright, 12GA	40' x 6'	\$54.00
PRKUP12642 □□	Frame, Upright, 12GA	42' x 6'	\$55.00
PRKUP12648 □□	Frame, Upright, 12GA	48' x 6'	\$56.00
PRKUP12736 □□	Frame, Upright, 12GA	36' x 7'	\$57.00
PRKUP12742 □□	Frame, Upright, 12GA	42' x 7'	\$43.47
PRKUP12824 □□	Frame, Upright, 12GA	24' x 8'	\$53.90
PRKUP12830 □□	Frame, Upright, 12GA	30' x 8'	\$78.00

Stock No.	Description	Dim. (D/H)	Price
PRKUP141042 □□	Frame, Upright, 14GA	42' x 10'	\$69.00
PRKUP141048 □□	Frame, Upright, 14GA	48' x 10'	\$70.00
PRKUP141130 □□	Frame, Upright, 14GA	30' x 11'	\$84.00
PRKUP141148 □□	Frame, Upright, 14GA	48' x 11'	\$71.00
PRKUP141218 □□	Frame, Upright, 14GA	18' x 12'	\$55.00
PRKUP141224 □□	Frame, Upright, 14GA	24' x 12'	\$70.00
PRKUP141230 □□	Frame, Upright, 14GA	30' x 12'	\$65.00
PRKUP141236 □□	Frame, Upright, 14GA	36' x 12'	\$72.00
PRKUP141240 □□	Frame, Upright, 14GA	40' x 12'	\$73.00
PRKUP141242 □□	Frame, Upright, 14GA	42' x 12'	\$77.00
PRKUP141248 □□	Frame, Upright, 14GA	48' x 12'	\$79.00
PRKUP141330 □□	Frame, Upright, 14GA	30' x 13'	\$84.00

72

1 — Select a finish color.

2 — Place 2-digit color code at end of stock no.

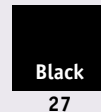
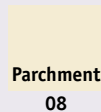

Additional colors may be available. Please call 202 305-3707 or 859 225-4824 for more information.

Stock No.	Description	Dim. (D/H)	Price
PRKUP12836 □□	Frame, Upright, 12GA	36' x 8'	\$63.00
PRKUP12840 □□	Frame, Upright, 12GA	40' x 8'	\$64.00
PRKUP12842 □□	Frame, Upright, 12GA	42' x 8'	\$65.00
PRKUP12848 □□	Frame, Upright, 12GA	48' x 8'	\$66.00
PRKUP12924 □□	Frame, Upright, 12GA	24' x 9'	\$64.00
PRKUP12930 □□	Frame, Upright, 12GA	30' x 9'	\$81.00
PRKUP12936 □□	Frame, Upright, 12GA	36' x 9'	\$67.00
PRKUP12940 □□	Frame, Upright, 12GA	40' x 9'	\$68.00
PRKUP12942 □□	Frame, Upright, 12GA	42' x 9'	\$69.00
PRKUP12948 □□	Frame, Upright, 12GA	48' x 9'	\$70.00
PRKUP141024 □□	Frame, Upright, 14GA	24' x 10'	\$60.00
PRKUP141030 □□	Frame, Upright, 14GA	30' x 10'	\$60.00
PRKUP141036 □□	Frame, Upright, 14GA	36' x 10'	\$66.00
PRKUP141040 □□	Frame, Upright, 14GA	40' x 10'	\$67.00

Stock No.	Description	Dim. (D/H)	Price
PRKUP141424 □□	Frame, Upright, 14GA	24' x 14'	\$85.00
PRKUP141430 □□	Frame, Upright, 14GA	30' x 14'	\$86.00
PRKUP141436 □□	Frame, Upright, 14GA	36' x 14'	\$88.00
PRKUP141442 □□	Frame, Upright, 14GA	42' x 14'	\$90.00
PRKUP141448 □□	Frame, Upright, 14GA	48' x 14'	\$91.20
PRKUP141454 □□	Frame, Upright, 14GA	54' x 14'	\$93.00
PRKUP141618 □□	Frame, Upright, 14GA	18' x 16'	\$81.00
PRKUP141640 □□	Frame, Upright, 14GA	40' x 16'	\$100.00
PRKUP141648 □□	Frame, Upright, 14GA	48' x 16'	\$103.00
PRKUP141748 □□	Frame, Upright, 14GA	48' x 17'	\$105.00
PRKUP141830 □□	Frame, Upright, 14GA	30' x 18'	\$112.00
PRKUP141836 □□	Frame, Upright, 14GA	36' x 18'	\$114.00
PRKUP141848 □□	Frame, Upright, 14GA	48' x 18'	\$118.00
PRKUP142040 □□	Frame, Upright, 14GA	40' x 20'	\$131.00

Stock No.	Description	Dim. (D/H)	Price
PRKUP14436 □□	Frame, Upright, 14GA	36" x 4'	\$43.00
PRKUP14440 □□	Frame, Upright, 14GA	40" x 4'	\$44.00
PRKUP14442 □□	Frame, Upright, 14GA	42" x 4'	\$45.00
PRKUP14448 □□	Frame, Upright, 14GA	48" x 4'	\$46.00
PRKUP14536 □□	Frame, Upright, 14GA	36" x 5'	\$45.00
PRKUP14548 □□	Frame, Upright, 14GA	48" x 5'	\$46.00
PRKUP14624 □□	Frame, Upright, 14GA	24" x 6'	\$47.00
PRKUP14630 □□	Frame, Upright, 14GA	30" x 6'	\$48.00
PRKUP14636 □□	Frame, Upright, 14GA	36" x 6'	\$49.00
PRKUP14640 □□	Frame, Upright, 14GA	40" x 6'	\$50.00
PRKUP14642 □□	Frame, Upright, 14GA	42" x 6'	\$51.00
PRKUP14648 □□	Frame, Upright, 14GA	48" x 6'	\$52.00
PRKUP14732 □□	Frame, Upright, 14GA	32" x 7'	\$46.00

Rigid Wall Mount Bracket

Roll-formed wall brackets provide extra support and space rack from wall. Bolts not included.

RIGID WALL MOUNT BRACKETS

Stock No.	Description	Dim. (W/L)	Price
PRKBRKTWL10 □□	BRKT, WL-MNT, rigid, 12GA	3' x 10"	\$7.00
PRKBRKTWL12 □□	BRKT, WL-MNT, rigid, 12GA	3' x 12"	\$7.50
PRKBRKTWL15 □□	BRKT, WL-MNT, rigid, 12GA	3' x 15"	\$8.00
PRKBRKTWL18 □□	BRKT, WL-MNT, rigid, 12GA	3' x 18"	\$8.50
PRKBRKTWL24 □□	BRKT, WL-MNT, rigid, 12GA	3' x 24"	\$9.00
PRKBRKTWL36 □□	BRKT, WL-MNT, rigid, 12GA	3' x 36"	\$9.50
PRKBRKTWL4 □□	BRKT, WL-MNT, rigid, 12GA	3' x 4"	\$6.00
PRKBRKTWL6 □□	BRKT, WL-MNT, rigid, 12GA	3' x 6"	\$6.50
PRKBRKTWL8 □□	BRKT, WL-MNT, rigid, 12GA	3' x 8"	\$6.75

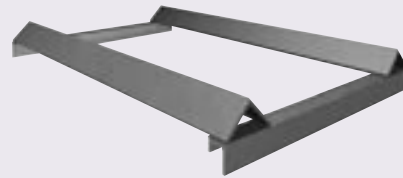
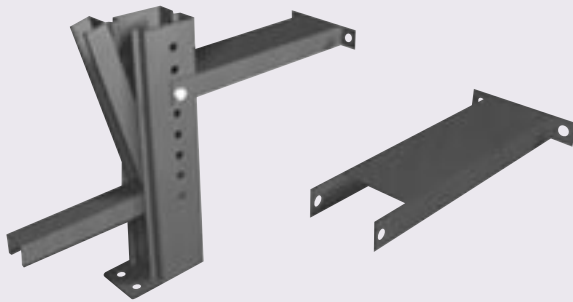

Stock No.	Description	Dim. (D/H)	Price
PRKUP14736 □□	Frame, Upright, 14GA	36" x 7'	\$51.00
PRKUP14748 □□	Frame, Upright, 14GA	48" x 7'	\$53.00
PRKUP14824 □□	Frame, Upright, 14GA	24" x 8'	\$54.00
PRKUP14830 □□	Frame, Upright, 14GA	30" x 8'	\$55.00
PRKUP14836 □□	Frame, Upright, 14GA	36" x 8'	\$56.00
PRKUP14840 □□	Frame, Upright, 14GA	40" x 8'	\$57.00
PRKUP14842 □□	Frame, Upright, 14GA	42" x 8'	\$58.00
PRKUP14848 □□	Frame, Upright, 14GA	48" x 8'	\$59.00
PRKUP14930 □□	Frame, Upright, 14GA	30" x 9'	\$58.00
PRKUP14936 □□	Frame, Upright, 14GA	36" x 9'	\$59.00
PRKUP14940 □□	Frame, Upright, 14GA	40" x 9'	\$60.00
PRKUP14942 □□	Frame, Upright, 14GA	42" x 9'	\$61.00
PRKUP14948 □□	Frame, Upright, 14GA	48" x 9'	\$62.00

Drum Cradles

This 12-gauge steel welded unit fits between shelf beams for secure storage of drums, barrels, and other cylindrical items. Available in 36", 40", 42", and 48" depths.

DRUM CRADLES

Stock No.	Description	Dim. (D)	Price
PRKDRMCRD36 □□	Cradle, Drum	36"	\$17.00
PRKDRMCRD40 □□	Cradle, Drum	40"	\$18.00
PRKDRMCRD42 □□	Cradle, Drum	42"	\$19.00
PRKDRMCRD48 □□	Cradle, Drum	48"	\$20.00

INDUSTRIAL RACKING

Industrial Pallet Racking

Row Spacers

Row spacers provide extra support and space from row to row.

ROW SPACERS

Stock No.	Description	Dim. (L)	Price
PRKROWSPC10 □□	Spacer, Row, Rigid, 12GA	10"	\$7.00
PRKROWSPC10 □□	Spacer, Row, Rigid, 12GA	10"	\$7.00
PRKROWSPC10 □□	Spacer, Row, Rigid, 12GA	10"	\$7.00
PRKROWSPC10 □□	Spacer, Row, Rigid, 12GA	10"	\$7.00
PRKROWSPC10 □□	Spacer, Row, Rigid, 12GA	10"	\$7.00
PRKROWSPC10 □□	Spacer, Row, Rigid, 12GA	10"	\$7.00
PRKROWSPC10 □□	Spacer, Row, Rigid, 12GA	10"	\$7.00

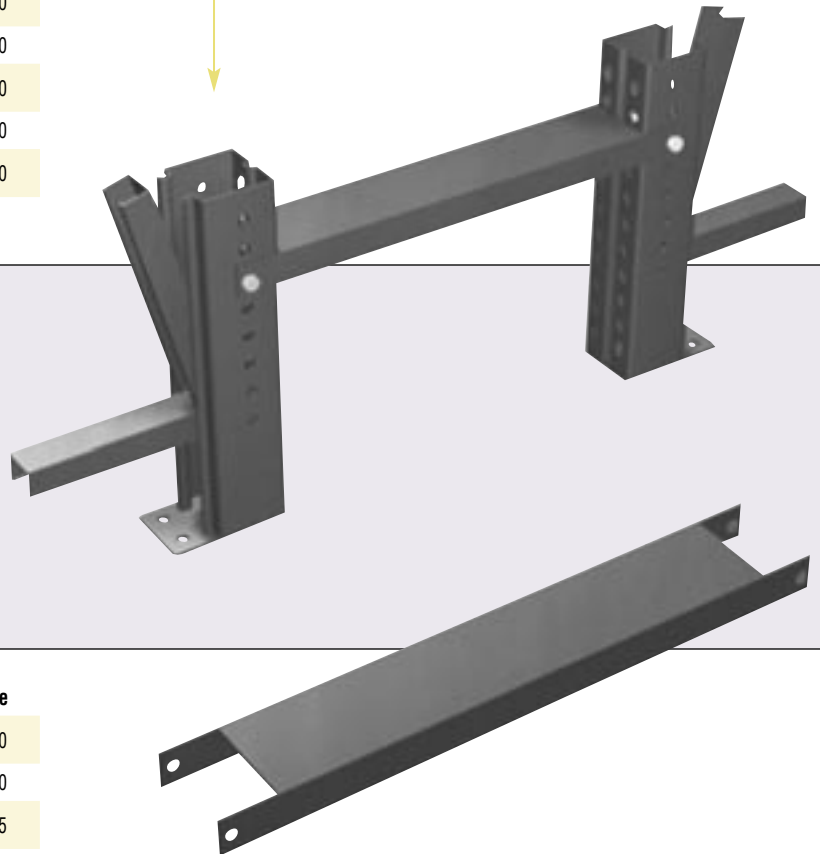

Stock No.	Description	Dim. (L)	Price
PRKROWSPC10 □□	Spacer, Row, Rigid, 12GA	10"	\$7.00
PRKROWSPC12 □□	Spacer, Row, Rigid, 12GA	12"	\$7.50
PRKROWSPC14 □□	Spacer, Row, Rigid, 12GA	14"	\$7.75
PRKROWSPC16 □□	Spacer, Row, Rigid, 12GA	16"	\$8.00
PRKROWSPC18 □□	Spacer, Row, Rigid, 12GA	18"	\$8.25
PRKROWSPC19 □□	Spacer, Row, Rigid, 12GA	19"	\$8.50
PRKROWSPC20 □□	Spacer, Row, Rigid, 12GA	20"	\$9.00
PRKROWSPC21 □□	Spacer, Row, Rigid, 12GA	21"	\$9.50
PRKROWSPC24 □□	Spacer, Row, Rigid, 12GA	24"	\$10.25
PRKROWSPC36 □□	Spacer, Row, Rigid, 12GA	36"	\$10.75
PRKROWSPC3 □□	Spacer, Row, Rigid, 12GA	3"	\$6.00
PRKROWSPC4 □□	Spacer, Row, Rigid, 12GA	4"	\$6.25
PRKROWSPC6 □□	Spacer, Row, Rigid, 12GA	6"	\$6.50
PRKROWSPC8 □□	Spacer, Row, Rigid, 12GA	8"	\$6.75

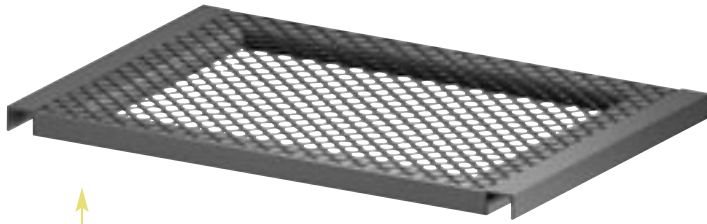

Expanded Metal Decking

Expanded metal decking functions as a solid deck while offering the advantage of a mesh surface. Decking is manufactured using 12-gauge crossbars, 14-gauge bracing, and 3/4 No. 9 expanded metal.

Stock No.	Dim. (W/D)	Price
PRKDKEK4048 □□	48" x 40"	\$57.50
PRKDKEK4053 □□	53" x 40"	\$63.00
PRKDKEK4060 □□	60" x 40"	\$63.75
PRKDKEK4072 □□	72" x 40"	\$71.00
PRKDKEK4224 □□	24" x 42"	\$48.00
PRKDKEK4236 □□	36" x 42"	\$48.50
PRKDKEK4248 □□	48" x 42"	\$59.75
PRKDKEK4253 □□	53" x 42"	\$64.00

1 — Select a finish color.

2 — Place 2-digit color code at end of stock no.

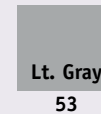
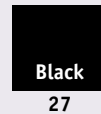
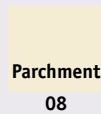

Additional colors may be available. Please call 202 305-3707 or 859 225-4824 for more information.

EXPANDED METAL DECKING

Stock No.	Dim. (W/D)	Price
PRKDKEK2436 □□	36" x 24"	\$41.35
PRKDKEK2448 □□	48" x 24"	\$44.29
PRKDKEK2460 □□	60" x 24"	\$49.75
PRKDKEK3053 □□	53" x 30"	\$50.64
PRKDKEK3636 □□	36" x 36"	\$52.22
PRKDKEK3642 □□	42" x 36"	\$53.24
PRKDKEK3648 □□	48" x 36"	\$54.00
PRKDKEK3653 □□	53" x 36"	\$56.00
PRKDKEK3660 □□	60" x 36"	\$56.80
PRKDKEK3672 □□	72" x 36"	\$60.10
PRKDKEK4036 □□	36" x 40"	\$56.28
PRKDKEK4042 □□	42" x 40"	\$57.00

Stock No.	Dim. (W/D)	Price
PRKDKEK4260 □□	60" x 42"	\$71.00
PRKDKEK4272 □□	72" x 42"	\$73.00
PRKDKEK4824 □□	24" x 48"	\$53.84
PRKDKEK4836 □□	36" x 48"	\$57.21
PRKDKEK4840 □□	40" x 48"	\$66.63
PRKDKEK4848 □□	48" x 48"	\$69.02
PRKDKEK4853 □□	53" x 48"	\$71.10
PRKDKEK4860 □□	60" x 48"	\$79.25
PRKDKEK4872 □□	72" x 48"	\$82.54
PRKDKEK5448 □□	48" x 54"	\$68.40
PRKDKEK5453 □□	53" x 54"	\$75.54

INDUSTRIAL RACKING

Industrial Pallet Racking

CORNER GUARDS

Stock No.	Dim. (H)	Price
PRKGRDCRN18 □□	18"	\$11.25
PRKGRDCRN36 □□	36"	\$12.50
PRKGRDCRN95 □□	9.5"	\$9.00

*Special order

Corner Guards and Bump Rails
 Protects support corners from impact, providing extra safety. Upright Frame Corner Guard safeguards corners from impact, and the bump guard rail protects throughout the aisle to keep lifts from accidental hits on rack system.

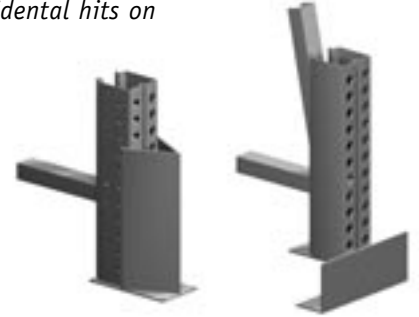

76

1 — Select a finish color.

2 — Place 2-digit color code at end of stock no.

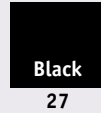
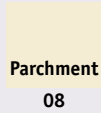

Additional colors may be available. Please call 202 305-3707 or 859 225-4824 for more information.

BUMP RAILS

Stock No.	Description	Price
PRKBMPRAIL5 □□	Bump Rail, Forklift, 3" x 5" x 3/8" T x 120L	\$65.00
PRKENDRAD □□	ASSY, End Rail, 3" x 5" x 3/8" x 2' Radius	\$350.00

Channel Decking

14-gauge corrugated steel channel decking provides a strong, flat storage area within the full amount of space between the steps of the beams, providing maximum storage space for boxes and other bulk items. Made in the same depth size as upright frames in 12" wide locking increments. Available in 18- and 20-gauge on special quote.

CHANNEL DECKING

Stock No.	Dim. (W/D)	Price
PRKDKCHN24 □□	12" x 24"	\$9.50
PRKDKCHN36 □□	12" x 36"	\$12.75
PRKDKCHN40 □□	12" x 40"	\$13.50
PRKDKCHN42 □□	12" x 42"	\$13.75
PRKDKCHN48 □□	12" x 48"	\$14.75

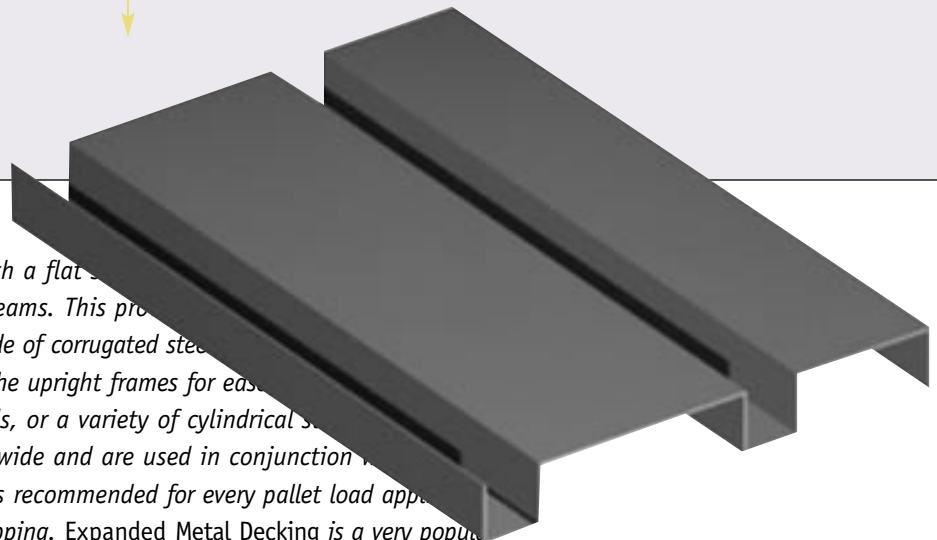

PALLET RACKING OPTIONS

Channel decking provides the user with a flat surface that fits in between the steps of the beams. This provides a secure storage area for boxes or any storage requirements. Made of corrugated steel, it is made in the same description depth size as the upright frames for easy installation. The cradle provides space for drums, barrels, or a variety of cylindrical storage. Heavy Duty Flanged Crossbars are 3" wide and are used in conjunction with pallets. A minimum of two crossbars is recommended for every pallet load applied. A 90-degree hook prevents accidental slipping. Expanded Metal Decking is a very popular method of storage. UNICOR's quality design and multi-task functions make this shelving very desirable. With the expanded metal decking the surface is open, but it can also be used as a solid deck. The "open" feature of this decking meets safety and fire standards and has a very appealing appearance.

INDUSTRIAL RACKING

Industrial Stacking Racks

Stacking Racks

Pallet stacking racks stack together for instant forklift-ready storage, then nest neatly together when unneeded, taking up very little floor space. Wood pallets can be forked right on the racks or the entire rack can be used as a pallet. Available in 13 models in 3000-lb.

and 4000-lb. load capacities, the units are made of tube steel in a rigid post and brace structure that provides maximum strength with maximum weight. Color coding identifies size and load capacity. Ideal for supply depot operations and food storage facilities.



STACKING RACKS

Stock No.	Description	Dim. (W/D/H)	Price
3990012276000	Rack, Stack, 3K, Blue	53" x 48" x 48"	\$128.00
3990012276001	Rack, Stack, 3K, Orange	53" x 48" x 42"	\$125.00
3990012276003	Rack, Stack, 3K, Yellow	53" x 42" x 42"	\$122.00
3990012625955	Rack, Stack, 3K, Beige	53" x 42" x 48"	\$124.00
3990012276002	Rack, Stack, 4K, Green	53" x 48" x 54"	\$137.00



78

stacking racks



nested stacking racks

Stock No.	Description	Dim. (W/D/H)	Price
3990013134497	Rack, Stack, 4K, Green	64" x 64" x 48"	\$164.00
3990013146004	Rack, Stack, 3K, Gray	53" x 48" x 64"	\$139.00
3990013152782	Rack, Stack, 4K, Brown	48" x 48" x 54"	\$135.00
3990013152783	Rack, Stack, 4K, Yellow	60" x 60" x 42"	\$157.00
3990013152784	Rack, Stack, 3K, Orange	72" x 48" x 48"	\$142.00
3990013152785	Rack, Stack, 4K, Gray	53" x 48" x 64"	\$141.00
3990013152786	Rack, Stack, 4K, Orange	53" x 48" x 72"	\$144.00
3990013531115	Rack, Stack, 3K, Green	72" x 60" x 60"	\$163.00

3K = 3,000-lb. load capacity
4K = 4,000-lb. load capacity



Tire Rack

Stacking tire racks enable you to store tires quickly with a forklift. Racks are manufactured using 2" square 14-gauge tubes. Sizes vary. Rack bases can be manufactured to meet your storage application. Call our technical representative at 202 305-3707 or 405 262-4875 ext. 391.

- 1 — Select a finish color.
- 2 — Place 2-digit color code at end of stock no.

Gray 53	Parchment 08	Black 27
Orange 03	Lt. Gray 53	Sand 28

Additional colors may be available. Please call 202 305-3707 or 859 225-4824 for more information. Colors above are for Tire Rack Base and Post

TIRE RACKS: BASE

Stock No.	Description	Dim. (W/D)	Price
BASETIRES46 □□	Base, Tire, Double-stacked	6' x 4'	\$154.00
BASETIRES356 □□	Base, Tire, Single-stacked	6' x 3.5'	\$137.00
BASETIRES36 □□	Base, Tire, Single-stacked	6' x 3'	\$134.00
BASETIRES46 □□	Base, Tire, Single-stacked	6' x 4'	\$140.00

TIRE RACKS: POST

Stock No.	Description	Dim. (L)	Price
POSTTIRE33 □□	Post, Tire	33"	\$13.00
POSTTIRE57 □□	Post, Tire	57"	\$16.00
POSTTIRE45 □□	Post, Tire	45"	\$14.00

INDUSTRIAL RACKING

Catwalk Systems and Mezzanines



80

UNICOR can design a customized unit to meet your requirements and specifications. Each mezzanine system is different; therefore, contacting a UNICOR technical representative is your first step. Please call 202 305-3707 or 405 262-4875 ext. 391.



CATWALK SYSTEMS

Custom quality Catwalk structures are available through our industrial products program. In conjunction with industrial shelving, UNICOR manufactures components used in the Catwalk product line. Installation is available, upon ordering, through experienced professional contracted installers with complete product knowledge. Metal shelving is available in the shelving section of this catalog.



INDUSTRIAL RACKING

Catwalk Systems and Mezzanines

Starter Units

Begin your catwalk and mezzanine system with one starter unit, featuring four corner columns. Then connect with as many add-on units as needed.

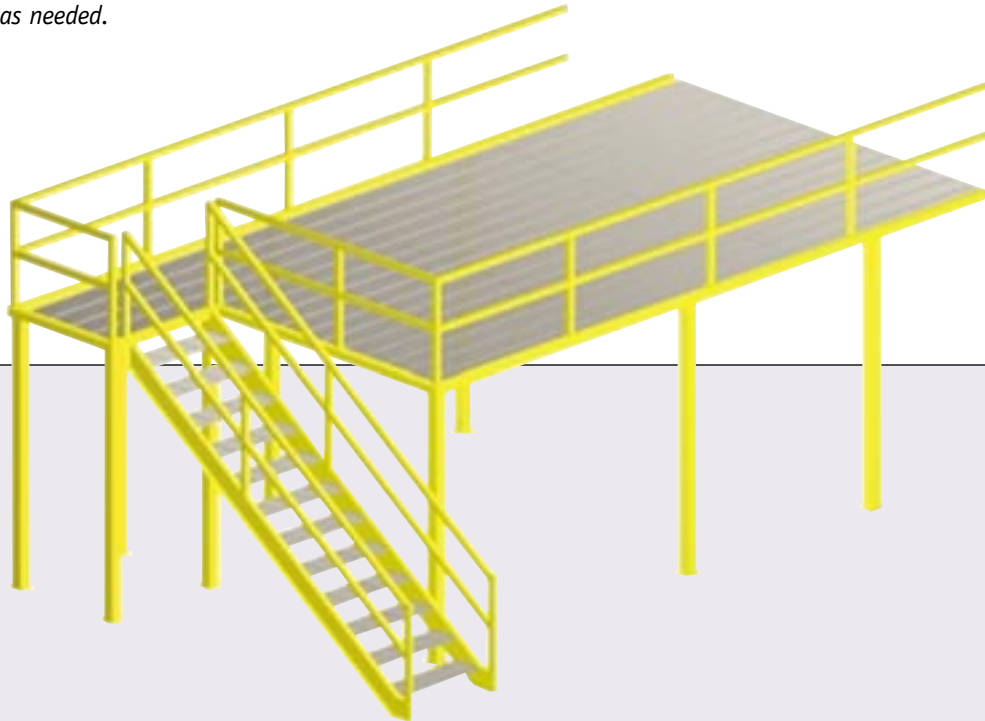

Add-on Units

Add-on modules have two intermediate columns and connect with each other to create as large a system as space allows. Units connect where girders meet.



Special Notice: UNICOR offers a complete turnkey process for your mezzanine requirements. Our technical specialists review your specifications and custom design a system to maximize your space. Each system is fully installed using UNICOR's government contract installer and all projects are covered under UNICOR's standard guarantee. Each mezzanine system is different; therefore, contacting a UNICOR technical representative is your first step. Please call 202 305-3707 or 859 225-4824.

Bar Grating

Standard surface is steel bar grating (19W4 or 19W2). Other less expensive style surfaces also available.

Hand Rails

Steel hand rails, 42" high and 1½" square tube, for all open areas of catwalks provide reliable security.

Stairs, Ladders, Steps, and Landings

Steel fabricated stairs, ladders, and steps are easy to install. Choose from the variety of models. Landing units include grating plus handrail and kickplate for two sides.

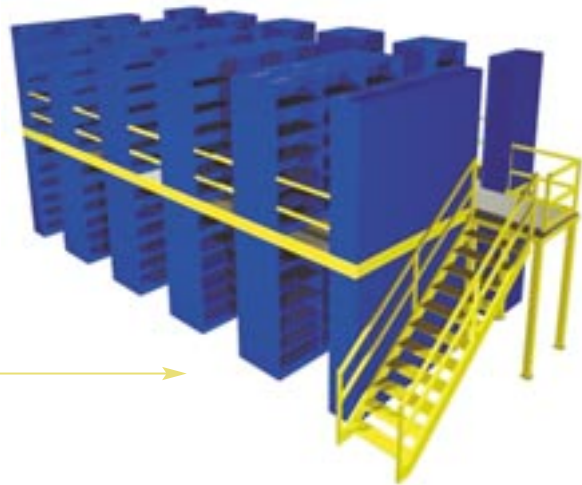
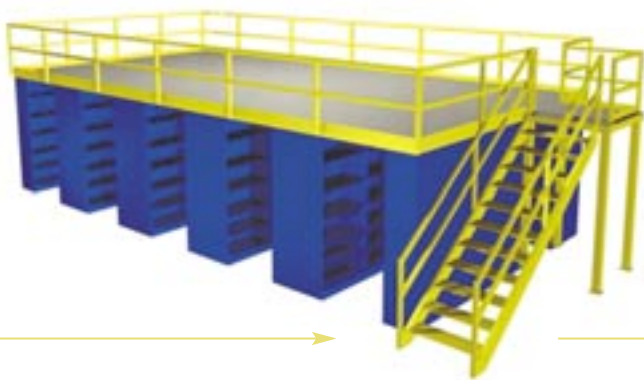
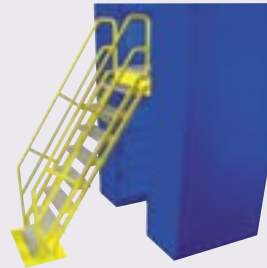
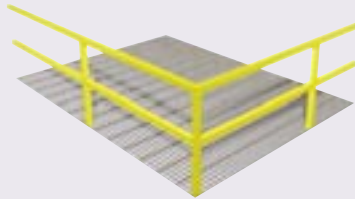

INDUSTRIAL RACKING

Industrial Cantilever Racks



84

Cantilever Racks

For heavy, oversized, large, and odd-sized items, cantilever racking is ideal because it provides long expanses of horizontal storage with no space lost to uprights. Access for loading and unloading is easier. Cantilever racks are available in single storage and double storage shelving, in light and heavy-duty capacities.

The cantilever design ensures easy assembly and adjustment with fool-proof removal and replacement of arms. Simply fasten arms to columns with locking bracket pins. The heavier the load, the greater the clamping action and rigidity of the system. And because arms function independently of each other, individual stock locations can be exactly the dimensions you need.



THE CANTILEVER CAPACITIES are dependent on the length of the section or row; the type, height, and number of uprights; the number and size of the arms; and the size of the base. The capacity of the uprights is listed in the item description. The allowable capacity is determined by the overall system's design. The total arm capacity (2,000 lb. light duty, 4,000 lb. heavy-duty structural) must not add up to more than the upright capacity. To increase the capacity of the overall section, uprights, shorter arms, and larger bases may be used. There are several styles of cantilever uprights, including the seismic rated capacity type. Because of the complexity that the combination of these options creates, it is suggested that the manufacturer review the overall design of the system. The load information (weight and cubic measurements of the load) will be necessary to calculate an adequate design of the system. Please feel free to use our expert technical support for any cantilever system requirements.

INDUSTRIAL RACKING

Industrial Cantilever Racks



86

CANTILEVER ARMS

Stock No.	Description	Dim.	Weight (LBS)	Price
CTLARMHDS24 <input type="checkbox"/> <input type="checkbox"/>	Cant-arm, Std, H/D, Structural	24"	19.6	\$38.00
CTLARMHDS36 <input type="checkbox"/> <input type="checkbox"/>	Cant-arm, Std, H/D, Structural	36"	29.3	\$55.00
CTLARMHDS48 <input type="checkbox"/> <input type="checkbox"/>	Cant-arm, Std, H/D, Structural	48"	45	\$65.00
CTLARMHDS60 <input type="checkbox"/> <input type="checkbox"/>	Cant-arm, Std, H/D, Structural	60"	100	\$90.00
CTLARMLDS24 <input type="checkbox"/> <input type="checkbox"/>	Cant-arm, Std, H/D, Structural	24"	18.5	\$49.25
CTLARMLDS36 <input type="checkbox"/> <input type="checkbox"/>	Cant-arm, Std, H/D, Structural	36"	25.8	\$44.00
CTLARMLDS48 <input type="checkbox"/> <input type="checkbox"/>	Cant-arm, Std, H/D, Structural	48"	36	\$54.00

The boxes at the end of the Stock No. designate the product color code. For the cantilever systems, use {03-orange or 53-gray}.

See cover flap for color swatches.

DECKING OPTIONS

Bar grating has been a very desirable decking method for the cantilever and stacking rack products. Bar grating is priced by the square foot and is quoted according to the system requirements.

Decking options are available and must be quoted according to system configurations. Cantilever systems are available for seismic rated regions. Complete installation and engineering studies are also available at an additional charge. Call for price at 202 305-3707, 202 305-3784, or 800 827-3168.

* Additional sizes are available. Please call us for a quote at 202 305-3707 or 405 262-4875 ext. 391.

CANTILEVER UPRIGHTS AND BASES

Stock No.	Description	Dim.	Weight (LBS)	Price
CTLUPS1248 □□	Cant-uprt, Std, 14,000, Sgl	12', 48" arms*	500	\$461.00
CTLUPS1448 □□	Cant-uprt, Std, 14,000, Sgl	14', 48" arms*	560	\$515.00
CTLUPS1648 □□	Cant-uprt, Std, 14,000, Sgl	16', 48" arms*	615	\$560.00
CTLUPS1848 □□	Cant-uprt, Std, 14,000, Sgl	18', 48" arms*	675	\$601.00
CTLUPS1236 □□	Cant-uprt, Std, 18,000, Sgl	12', 36" arms*	480	\$444.00
CTLUPS1436 □□	Cant-uprt, Std, 18,000, Sgl	14', 36" arms*	540	\$497.00
CTLUPS1636 □□	Cant-uprt, Std, 18,000, Sgl	16', 36" arms*	595	\$541.00
CTLUPS1836 □□	Cant-uprt, Std, 18,000, Sgl	18', 36" arms*	655	\$582.00
CTLUPS1224 □□	Cant-uprt, Std, 28,000, Sgl	12', 24" arms*	460	\$426.00
CTLUPS1424 □□	Cant-uprt, Std, 28,000, Sgl	14', 24" arms*	520	\$488.00

Stock No.	Description	Dim.	Weight (LBS)	Price
CTLUPS1836 □□	Cant-uprt, Std, 40,000, Sgl	18', 36" arms*	708	\$628.00
CTLUPS1224 □□	Cant-uprt, Std, 60,000, Sgl	12', 24" arms*	493	\$456.00
CTLUPS1424 □□	Cant-uprt, Std, 60,000, Sgl	14', 24" arms*	553	\$506.00
CTLUPS1624 □□	Cant-uprt, Std, 60,000, Sgl	16', 24" arms*	612	\$557.00
CTLUPS1824 □□	Cant-uprt, Std, 60,000, Sgl	18', 24" arms*	672	\$607.00

The boxes at the end of the Stock No. designate the product color code. For the cantilever systems, use {03-orange or 53-gray}.

See cover flap for color swatches.

- 1 Select a finish color.
- 2 Place 2-digit color code at end of stock no.

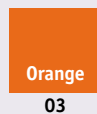

Additional colors may be available. Please call 202 305-3707 or 859 225-4824 for more information.

Stock No.	Description	Dim.	Weight (LBS)	Price
CTLUPS1624 □□	Cant-uprt, Std, 28,000, Sgl	16', 24" arms*	575	\$525.00
CTLUPS1824 □□	Cant-uprt, Std, 28,000, Sgl	18', 24" arms*	635	\$562.00
CTLUPS1248 □□	Cant-uprt, Std, 30,000, Sgl	12', 48" arms*	565	\$520.00
CTLUPS1448 □□	Cant-uprt, Std, 30,000, Sgl	14', 48" arms*	624	\$573.00
CTLUPS1648 □□	Cant-uprt, Std, 30,000, Sgl	16', 48" arms*	684	\$621.00
CTLUPS1848 □□	Cant-uprt, Std, 30,000, Sgl	18', 48" arms*	744	\$661.00
CTLUPS1236 □□	Cant-uprt, Std, 40,000, Sgl	12', 36" arms*	529	\$488.00
CTLUPS1436 □□	Cant-uprt, Std, 40,000, Sgl	14', 36" arms*	588	\$540.00
CTLUPS1636 □□	Cant-uprt, Std, 40,000, Sgl	16', 36" arms*	648	\$590.00

CANTILEVER HORIZONTAL BRACING

Stock No.	Description	Dim. (L)	Weight (LBS)	Price
CTLHRZBRC48 □□	Horizontal-brace, Cant-uprt	48"	67	\$118.00
CTLHRZBRC60 □□	Horizontal-brace, Cant-uprt	60"	84	\$124.00
CTLHRZBRC72 □□	Horizontal-brace, Cant-uprt	72"	101	\$130.00

The boxes at the end of the Stock No. designate the product color code. For the cantilever systems use {03-orange or 53-gray}.

See cover flap for color swatches.

* The cantilever arms are made of structural steel. Capacities are determined by the designated {HD}-4,000 lb. heavy-duty and {LD}-2,000 lb. light duty. Overall system capacities are determined using a mathematical formula. Please call the factory for capacity assistance.

FOOD SERVICE

Stainless Steel



88

UNICOR is a Certified Custom Builder

Under the National Sanitary Foundation standard #2, UNICOR is a certified custom builder. All products are warranted to meet the high quality standards of Military and Federal specifications.

First-Rate Quality

UNICOR products use high grade stainless steel, giving food service equipment greater durability and a longer work life without rusting. Most stainless steel food service equipment is tig-welded for sturdy construction and ease of cleaning.

Internet Orders:

www.unicor.gov

UNICOR manufactures a complete line of very high-quality food service equipment. Your investment in quality food service equipment will serve you well for years to come.



prep table



pot and pan rack

Custom Services

Custom design and engineering services are available.

FOOD SERVICE

Prep Tables



Square Edge Food Prep Table

6-foot-long all stainless steel table ideal for virtually any food preparation job. Features heavy-duty 14-gauge top supported by sturdy 16-gauge tube legs with adjustable bullet feet. Comes with a removable, stainless, two-piece, 16-gauge undershelf. Shipped knocked down.

SQUARE EDGE FOOD PREP TABLE

Stock No.	Table Dim. (W/L/H)	Package Dim. (W/L/H)	Weight (LBS)	Cube* Price
7320 00 269 9231	30" x 72" x 36"	32" x 74" x 6"	166	8.3 \$743.00
7320 00 269 9232*	30" x 96" x 36"	32" x 98" x 6"	201	10.9 \$758.00

*Also available as an 8-foot long table.

Shipped unassembled.

90



Food Prep Table with Plastic Top

Removable 3/4" polyethylene top facilitates cleaning. A removable undershelf makes for all-purpose utility. Both legs and undershelf are made of 16-gauge stainless steel. Shipped knocked down.



Food Prep Table with Rolled Rim

14-gauge stainless steel table features 1 1/2" rolled down flange along its rim plus a convenient undershelf for storage. Sturdy tube legs have adjustable bullet feet. Shipped knocked down.

FOOD PREP TABLE WITH PLASTIC TOP

Stock No.	Table Dim. (W/L/H)	Package Dim. (W/L/H)	Weight (LBS)	Cube* Price
7320 00 985 7339	36" x 72" x 30"	38" x 74" x 12"	201	19.5 \$885.00

Shipped unassembled.

FOOD PREP TABLE WITH ROLLED RIM

Stock No.	Table Dim. (W/L/H)	Package Dim. (W/L/H)	Weight (LBS)	Cube* Price
7320 00 927 7462	30" x 72" x 35"	31" x 73" x 6"	200	7.3 \$680.00
7320 00 927 74631*	30" x 72" x 35"	31" x 73" x 6"	220	7.9 \$680.00

*Also available with heavy-duty 5" swivel casters with brakes and rolling bumpers to provide mobility while protecting walls, equipment, and fixtures.

Shipped unassembled.

Utility Table with Tube Shelf

Sturdy, 6-foot-long, all-purpose stainless steel table accommodates two workers and a wide range of applications, from kneading dough to trimming meat. Durable tube frame features a 16-gauge tubular undershelf, 5" heavy-duty casters with brakes, and rolling bumpers that prevent wall and sideboard damage.



UTILITY TABLE WITH TUBE SHELF

Stock No.	Table Dim. (W/L/H)	Package Dim. (W/L/H)	Weight (LBS)	Cube*	Price
7320 01 236 6920	36" x 72" x 36"	38" x 74" x 42"	261	68.4	\$692.00
7320 01 236 6929*	36" x 72" x 36"	38" x 74" x 42"	275	68.4	\$756.00

**Also available in a solid undershelf version ideal for storing large pots and pans or bulky foods. Shipped fully assembled.*



Food Prep Table with Marine Edge and Drawer

Heavy-duty stainless steel table with 1/2" raised edge all around to prevent spillage. Includes stainless steel undershelf and drawer with removable pan. 5" swivel casters with brakes and rolling bumpers provide mobility and protect walls and sideboards. Shipped knocked down.

Cutting Table with Tube Shelf

Easy-to-clean, stainless steel, 6-foot table with tubular undershelf for cutting meat, fish, fowl, or vegetables. Top surface features a 4" high, rolled rim splash guard on three sides to prevent spillage. Heavy-duty 5" casters with brakes and rolling bumpers provide mobility while protecting walls, equipment, and fixtures.

FOOD PREP TABLE WITH MARINE EDGE AND DRAWER

Stock No.	Table Dim. (W/L/H)	Package Dim. (W/L/H)	Weight (LBS)	Cube*	Price
7320 41 483 2019	36" x 72" x 30"	30" x 74" x 9"	225	11.3	\$743.00

Shipped unassembled.

CUTTING TABLE WITH TUBE SHELF

Stock No.	Table Dim. (W/L/H)	Package Dim. (W/L/H)	Weight (LBS)	Cube*	Price
7320 01 236 6919	36" x 72" x 36"	38" x 74" x 46"	306	74.9	\$715.00
7320 01 236 6918*	36" x 72" x 36"	38" x 74" x 46"	306	74.9	\$785.65

**Also available in a solid undershelf version ideal for storing large pots and pans or bulky foods. Shipped unassembled.*

FOOD SERVICE

Prep Tables

Four-Deck Pot and Pan Rack
 One of our most popular items, this extra-heavy-duty, 4-shelf rack is ideal for storing large pots and pans and other bulky items. All tubular stainless steel and continuous solid-welded construction includes adjustable bullet feet for leveling on uneven floors.



92

Table with Upper Shelf and Cutting Boards
 Designed to satisfy a host of needs, this super-heavy-duty table is the ideal workstation in the kitchen or bakery. The rear half of the work surface is 14-gauge stainless steel and the front half accommodates two removable (36" x 18") polyethylene cutting boards. Elevated 19" above the work surface is a 14-gauge stainless steel shelf (10" x 72") with an 8" high backsplash. Handy upper shelf serves as condiment, utensil, and food storage, or for cooling breads and dishes hot from the oven. Table includes a two-piece removable undershelf and legs with adjustable bullet feet.

FOUR-DECK POT AND PAN RACK

Stock No.	Rack Dim. (W/D/H)	Package Dim. (W/D/H)	Weight (LBS)	Cube*	Price
TPN 6643	72" x 26" x 64"	74" x 28" x 70"	250	83.9	\$850.00

TABLE WITH UPPER SHELF AND CUTTING BOARDS

Stock No.	Table Dim. (W/L/H)	Package Dim. (W/L/H)	Weight (LBS)	Cube*	Price
7320 00 042 7131	36" x 72" x 36" (63"H with upper shelf)	37" x 73" x 4"	240	65.7	\$1,263.00
7320 00 019 0627*	36" x 72" x 36" (50"H with backsplash)	37" x 73" x 42"	270	65.7	\$1,235.00
7320 00 042 7129**	36" x 72" x 36"	37" x 73" x 42"	240	65.7	\$1,135.00

*Also available with 14" high rear backsplash.

**Also available without upper shelf or backsplash.

Shipped unassembled.

Lineman Cart

Versatile 14-gauge stainless steel cart features two flat shelves. 4" splash guards prevent spillage. Built-in handle and 5" casters offer easy mobility from kitchen to serving line. Rubber bumpers protect walls and sideboards.

LINEMAN CART

Stock No.	Cart Dim. (W/L/H)	Package Dim. (W/L/H)	Weight (LBS)	Cube*	Price
7320 01 236 6922	28 1/2" x 44" x 46"	32" x 52" x 48"	140	46.3	\$535.00

Shipped unassembled.

TOASTER AND APPLIANCE CART

Stock No.	Cart Dim. (W/L/H)	Package Dim. (W/L/H)	Weight (LBS)	Cube*	Price
7320 01 236 6924 (cart only)	30" x 36" x 36"	32" x 38" x 42"	137	29.5	\$441.00

Shipped unassembled.

Toaster and Appliance Cart

Perfect for storing and moving small portable appliances such as microwaves, slicers, and mixers. 14-gauge stainless steel construction with top and bottom shelves, heavy-duty 5" swivel casters, wheel locks, and rubber bumpers. (Appliance not included.)

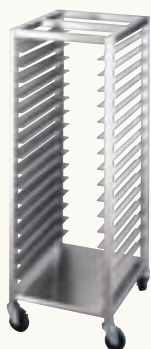

Bakery Cart

Compact, efficient cart stores a lot in a little space. Multiple tray-slides and solid bottom shelf spaced to provide easy access to 17 levels from each end of the cart. Heavy-duty 5" casters with brakes and rubber rolling bumpers for mobility and protection.

BAKERY CART

Stock No.	Cart Dim. (L/D/H)	Package Dim. (L/D/H)	Weight (LBS)	Cube*	Price
7320 01 236 6917	21 1/2" x 28" x 60"	23" x 66" x 30"	197	26.4	\$503.02

Shipped unassembled.

Dunnage Rack

Heavy-duty 16-gauge rack stores bulk materials in refrigerators, storerooms, or food prep areas. Designed to allow for easy cleaning under the rack even when in use.

DUNNAGE RACK

Stock No.	Rack Dim. (W/L/H)	Package Dim. (W/L/H)	Weight (LBS)	Cube*	Price
TPN 6157	24" x 48" x 18"	26" x 50" x 24"	50	18.1	\$693.80

*See additional Channel Dunnage Racks and Shelves in the Miscellaneous area of this Food Service section.

Shipped unassembled.

FOOD SERVICE

Miscellaneous

Mobile Storage Shelving

Practical and efficient, these mobile carts can be rolled in and out of coolers, freezers, and storage areas to create storage where and when needed. These sturdy, all stainless steel units are available in a variety of sizes. Heavy-duty 5" swivel casters (two with brakes) have rubber bumpers and provide quiet operation. Units meet MLL-2-40144E and GSA and DCASMA standards and specifications. Shipped unassembled, units are easily put together with simple hand tools. Instructions provided.



MOBILE STORAGE SHELVING

Stock No.	Description	Dim. (W/D/H)	Weight (LBS)	Cube	Price
7125 00 555 2663	5 Shelves	48" x 18" x 72"	112	4.23	\$476
7125 00 555 2732	5 Shelves	36" x 18" x 72"	92	3.36	\$419
7125 01 010 3092	5 Shelves	30" x 18" x 72"	85	2.92	\$392
7125 00 590 1768	5 Shelves	48" x 24" x 72"	137	5.51	\$545
7125 01 010 3091	5 Shelves	42" x 24" x 72"	117	4.81	\$512
7125 00 555 2720	5 Shelves	36" x 24" x 72"	112	4.23	\$471
7125 01 010 0698	5 Shelves	30" x 24" x 72"	96	2.29	\$437
7125 00 348 8028	4 Shelves	48" x 18" x 58"	97	3.73	\$390
7125 00 348 8026	4 Shelves	48" x 24" x 58"	107	4.73	\$460

Other sizes available upon request.
Shipped unassembled.

Nickel-Chrome Plated Shelving Unit

This practical and economical 4-level storage shelving unit is made of nickel-chrome plated low-carbon steel. These popular shelving units are a great value and an excellent solution to a variety of storage requirements. Leg levelers adjust for use on uneven floors. Unit meets GSA and Military Standards Specifications. Shipped unassembled, unit is easily put together with simple hand tools. Instructions are included.

NICKEL-CHROME PLATED SHELVING UNIT

Stock No.	Dim. (W/D/H)	Weight (LBS)	Cube*	Price
7125 00 707 3041	48" x 15" x 58"	66	3.38	\$195

Other sizes available upon request.
Shipped unassembled.



Kettle Stir Paddle

Perfect for blending large batches of soups, gravies, stews, and other recipes requiring folding or stirring. 11-gauge, all stainless steel construction with 16-gauge tube handle. Available in paddle design that incorporates six 1/4" holes on paddle surface for ease in blending. Paddles and handles available in a variety of sizes to match customer needs.

KETTLE STIR PADDLE

Stock No.	Description	Overall Length	Paddle (L/W)	Weight (LBS)	Cube*	Price
TPN 9903	Without Holes	48"	14" x 6"	5	0.4	\$50.00
TPN 9899	With Holes	48"	14" x 6"	5	0.4	\$55.00

Other sizes available upon request.
Shipped unassembled.

Mobile Dunnage Racks

Standard with four 8" posts, one 3-sided frame, one dunnage shelf, one wire grid, and four polyurethane casters (two swivel and two brake).

ADDITIONAL CHANNEL DUNNAGE SHELVES

Dim. (W/D)	Weight (LBS)	Plating-Plus		Gold-Bond	
		Stock No.	Price	Stock No.	Price
24" x 18"	16½	WFSCDU324Z	\$66.94	WFSCDU324Y	\$73.23
30" x 18"	20½	WFSCDU330Z	\$67.67	WFSCDU330Y	\$74.03
36" x 18"	24½	WFSCDU336Z	\$71.80	WFSCDU336Y	\$78.55
42" x 18"	28½	WFSCDU342Z	\$77.11	WFSCDU342Y	\$84.78
48" x 18"	32½	WFSCDU348Z	\$82.42	WFSCDU348Y	\$91.00
60" x 18"	38½	WFSCDU360Z	\$93.92	WFSCDU360Y	\$103.46

MOBILE CHANNEL DUNNAGE RACKS

Dim. (W/D)	Weight (LBS)	Plating-Plus		Gold-Bond	
		Stock No.	Price	Stock No.	Price
36" x 18"	28	WFSCDR336Z	\$102.90	WFSCDR336Y	\$114.58
48" x 18"	36	WFSCDR348Z	\$113.52	WFSCDR348Y	\$127.03
60" x 18"	42	WFSCDR360Z	\$125.02	WFSCDR360Y	\$139.44
36" x 24"	36	WFSCDR536Z	\$108.49	WFSCDR536Y	\$120.63
48" x 24"	47	WFSCDR548Z	\$115.98	WFSCDR548Y	\$129.91
60" x 24"	56	WFSCDR560Z	\$143.56	WFSCDR560Y	\$160.78

Shipped unassembled.



mobile dunnage rack



mobile channel dunnage rack

Dim. (W/D)	Weight (LBS)	Plating-Plus		Gold-Bond	
		Stock No.	Price	Stock No.	Price
24" x 24"	16½	WFSCDU524Z	\$69.93	WFSCDU524Y	\$76.44
30" x 24"	20½	WFSCDU530Z	\$73.67	WFSCDU530Y	\$80.53
36" x 24"	24½	WFSCDU536Z	\$77.39	WFSCDU536Y	\$84.60
42" x 24"	28½	WFSCDU542Z	\$81.13	WFSCDU542Y	\$88.41
48" x 24"	32½	WFSCDU548Z	\$84.88	WFSCDU548Y	\$93.88
54" x 24"	47½	WFSCDU554Z	\$98.88	WFSCDU554Y	\$109.32
60" x 24"	38½	WFSCDU560	\$112.88	WFSCDU560Y	\$124.75

Shipped unassembled.

MOBILE DUNNAGE RACKS

Dim. (W/D)	Weight (LBS)	Plating-Plus		Gold-Bond	
		Stock No.	Price	Stock No.	Price
36" x 18"	42	WFSMDR336Z	\$281.20	WFSMDR336Y	\$300.59
48" x 18"	50	WFSMDR348Z	\$307.28	WFSMDR348Y	\$329.95
60" x 18"	63	WFSMDR360Z	\$399.36	WFSMDR360Y	\$366.25
30" x 24"	42	WFSMDR530Z	\$283.07	WFSMDR530Y	\$302.64
36" x 24"	48	WFSMDR536Z	\$294.65	WFSMDR536Y	\$315.79
48" x 24"	54	WFSMDR548Z	\$320.78	WFSMDR548Y	\$343.82
60" x 24"	60	WFSMDR560Z	\$357.70	WFSMDR560Y	\$384.01

Shipped unassembled.

ADDITIONAL PRODUCTS

96



Storeroom Carts
Page 103

Internet Orders:

www.unicor.gov

UNICOR is committed to supplying the highest quality metal products to our customers. In this section we offer institutional beds, metal lumber, handtrucks and storeroom carts, casters, and more.



Segregation Beds

Page 100



Metal Lumber

Page 102



Dormitory Beds

Page 98

ADDITIONAL PRODUCTS

Dormitory Beds and Accessories

Institutional Beds

UNICOR offers both the round and square tube bed to the marketplace. They can be used as single units, or stacked to maximize room capacity for customer requirements.



98

ROUND TUBE DORMITORY BEDS – BUNKABLE

Stock No.	Description	Dim. (W/L)	Group	Weight (LBS)	Price
BEDROUND7936 □□	Bed, bunk, round-tube	36" x 79"	Bed	91.5	\$125
BEDROUND8436 □□	Bed, bunk, round-tube	36" x 84"	Bed	94	\$130

ROUND TUBE BED ACCESSORIES

Stock No.	Description	Dim. (W/L)	Group	Weight (LBS)	Price
BEDCONVRND □□	Bed, conversion unit, round tube		Bed	10	\$20.00
BEDCAPRND □□	Cap, bedpost, round tube		Bed	.25	.90
BEDGLIDERND □□	Glide, round tube		Bed	.25	.90
LADDERROUNDTUBE □□	Ladder, tube steel 15" w x 48" h	15" x 48"	Bed	10	\$45.00

SQUARE TUBE DORMITORY BEDS WITH WOOD INSETS, HEAD AND FOOT – BUNKABLE

Stock No.	Description	Dim. (W/L)	Group	Weight (LBS)	Price
BEDSQBTK7936 □□	Bed, Bunk, sq. tube, Burma Teak	36" x 79"	Bed	105	CALL
BEDSQLC07936 □□	Bed, Bunk, sq. tube, Lt. Carol. Oak	36" x 79"	Bed	110	CALL
BEDSQPS07936 □□	Bed, Bunk, sq. tube, Plain Sawn Oak	36" x 79"	Bed	105	CALL
BEDSQWW7936 □□	Bed, Bunk, sq. tube, Win. Walnut	36" x 79"	Bed	110	CALL
BEDSQBTK8436 □□	Bed, Bunk, sq. tube, Burma Teak	36" x 84"	Bed	105	CALL
BEDSQLC08436 □□	Bed, Bunk, sq. tube, Lt. Carol. Oak	36" x 84"	Bed	110	CALL
BEDSQPS08436 □□	Bed, Bunk, sq. tube, Plain Sawn Oak	36" x 84"	Bed	105	CALL
BEDSQWW8436 □□	Bed, Bunk, sq. tube, Plain Sawn Oak	36" x 84"	Bed	110	CALL

1 — Select a finish color.

2 — Place 2-digit color code at end of stock no.

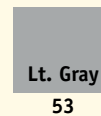
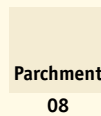

SQUARE TUBE BED ACCESSORIES

Stock No.	Description	Dim. (W/L)	Group	Weight (LBS)	Price
BEDCONVSQR □□	Bed, conversion unit, square tube		Bed	10	\$20.00
BEDCAPSQUARE □□	Cap, bedpost, square tube		Bed	.25	.90
BEDGLIDESQUARE □□	Glide, square tube		Bed	.25	.90
LADDERROUNDTUBE □□	Ladder, tube steel	15" x 48"	Bed	10	\$45.00

ADDITIONAL PRODUCTS

Segregation Units and Accessories



double segregation bed



Segregation Beds

The single segregation style bed comes fully welded. It can also receive the storage compartments and restraint loops when ordering.

SEGREGATION BEDS (SINGLE)

Stock No.	Description	Dim. (W/L/H)	Group	Weight (LBS)	Price
BEDSEGSGL27□□	Bed, Seg. Single	27" x 80"	Bed	144	\$150
BEDSEGSGL30□□	Bed, Seg. Single	30" x 80"	Bed	154	\$155
BEDSEGSGL32□□	Bed, Seg. Single	32" x 80"	Bed	144	\$160
BEDSEGSGL36□□	Bed, Seg. Single	36" x 80"	Bed	181	\$165

NOTE: Segregation Bed Shipping Options

Shipping charges vary depending on the destination, optional equipment, and quantity. Shipping charges will be significantly lower if the amount of full truckloads is reduced. UNICOR, FCI El Reno offers an optional "field welded" segregation style bed. The designation for this type bed is the "knockdown" (DKD) segregation bed. This style bed requires assembly by the customer. The legs of the beds are supplied with a gusset at the necessary locations to ease the assembly process. Assembly drawings of the bed are available upon request.

SEGREGATION BEDS (DOUBLE, FULLY ASSEMBLED AND WELDED)

Stock No.	Description	Dim. (W/L)	Group	Weight (LBS)	Price
BEDSEGDBL27□□	Bed, Seg. Double	27" x 80"	Bed	280	\$230
BEDSEGDBL30□□	Bed, Seg. Double	30" x 80"	Bed	300	\$235
BEDSEGDBL32□□	Bed, Seg. Double	32" x 80"	Bed	315	\$240
BEDSEGDBL36□□	Bed, Seg. Double	36" x 80"	Bed	331	\$250

SEGREGATION BEDS (DOUBLE, KNOCKED DOWN AND REQUIRING WELDING ON SITE)

Stock No.	Description	Dim. (W/L)	Group	Weight (LBS)	Price
BEDSEGDKD27□□	Bed, Seg. Double KD	27" x 80"	Bed	280	\$215
BEDSEGDKD30□□	Bed, Seg. Double KD	30" x 80"	Bed	300	\$220
BEDSEGDKD32□□	Bed, Seg. Double KD	32" x 80"	Bed	315	\$225
BEDSEGDKD36□□	Bed, Seg. Double KD	36" x 80"	Bed	331	\$235

Ladder

The "foot friendly" ladder has an angle iron for a flat step. This version of the bed ladder has the same overall dimensions as the standard round stepladder. For customer convenience both designs are now available. The ladders are welded into position. Customer must specify right or left side of bed.



LADDER

Stock No. Conversion Units	Description Angle and Round Stepladders	Dim. (W/H)	Group	Weight (LBS)	Price
LADDERROUNDTUBE □ □	Ladder, Bunk-bed, Angle, Step	15" x 48"	Bed	10	\$45.00

- 1 Select a finish color.
- 2 Place 2-digit color code at end of stock no.

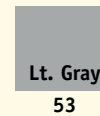
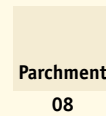

Inmate Segregation Desk

Segregation desks are built for security and durability. The desks have no removable parts and can be ordered fully welded together or shipped unassembled and welded on site. Specify sand or gray. All desks are welded.

**Handicapped segregation desks are available.*



SEGREGATION DESK

Stock No.	Description	Group	Weight (LBS)	Price
DESKSEGSQ □ □	Desk, Seg, Bop, Square tube	Mot	84	\$220.00

ADDITIONAL PRODUCTS

Metal Lumber and Miscellaneous

Metal Lumber

Slotted angles are the universal fasteners of metal shelving and support units. This multipurpose product can be cut, combined, and fastened together through pre-punched hole patterns into unlimited configurations for endless functions. Use for cross-aisle and down-aisle shelving, for tall package racking, hanging support for overhead doors, and more.

Available in 12- and 14-gauge galvanized steel. Sold in bundles of 10 pieces with 75 bolts and nuts.



examples of finished metal lumber pieces

Casters

- Take full advantage of the versatility of slotted angles with these specially designed casters.
- Attach these 3½" and 4" swivel casters to angles or corner gusset plates for instant mobility. In sets of four, hardware included. Each package contains 75 each of 5/16" x 3/4" bolts with nuts.
- The 3½" rigid caster is rated at 250-lb. capacity and measures 4^{11/16}" high x 5" long x 2½" wide. Wheel tread is 15/16" wide. Four mounting holes are 5/16" diameter and spaced 13/16" x 4".

102



flat caster CAS3R

flat caster CAS4R

swivel caster CAS3S



METAL LUMBER

Stock No.	Description	Dimension (L)	Price
SLA1210	Angle, Steel Slotted, 12GA, TY4, CL2	10.0'	\$133.00
SLA1212	Angle, Steel Slotted, 12GA, TY4, CL2	12.0'	\$174.00
SLA1215	Angle, Steel Slotted, 12GA, TY4, CL2	15.0'	\$214.00
SLA1410	Angle, Steel Slotted, 14GA, TY2, CL2	10.0'	\$88.00
SLA1412	Angle, Steel Slotted, 14GA, TY2, CL2	12.0'	\$137.00
SLA1415	Angle, Steel Slotted, 14GA, TY2, CL2	15.0'	\$162.00

- The 4" rigid caster is rated at 400-lb. capacity and measures 5^{1/8}" high x 6½" long x 3½" wide. Wheel tread is 19/16" wide. Four mounting holes are 3/8" diameter and spaced 1¾" x 5".
- The 3½" swivel caster is rated at 250-lb. capacity and measures 5" high x 4¼" long x 3¾" wide. Wheel tread is 15/16" wide. Mounting plate is 4¼" x 3¾" and has four 3/8" diameter x 3/4" long slots spaced 2^{5/8}" x 3^{1/8}".

CASTERS

Stock No.	Description	Wheel Dim.	Plate Dim.	Price
CAS3R	Caster, Flat	3½"	5" x 2½"	\$9.00
CAS4R	Caster, Flat	4"	6½" x 3¼"	\$10.00
CAS3S	Caster, Swivel	3½"	4¼" x 3¾"	\$16.00

Handtrucks

Handtrucks are constructed of sturdy steel pipe for heavy-duty use. Their beveled 14"W x 8"D bottom plate eases pick-up of loads, and 2" x 8" diameter durofoam wheels with bearings ensure smooth hauling. 500-lb load capacity. Available in 2-wheel and convertible 4-wheel styles.

HANDTRUCKS (DOLLY)

Stock No.	Description	Price
DOL2 □□	2 Wheels; Standard	\$50.00
DOL4 □□	4 Wheel; Convertible	\$99.00

Storeroom Carts

These aluminum storeroom carts are ideal for moving large and heavy items. Featuring fully welded construction and a diamond tread deck, these carts are strong, durable, and corrosion resistant. Each cart comes with 6" casters, two swivel w/brakes and two rigid. An aluminum push handle can be on either end of the cart.

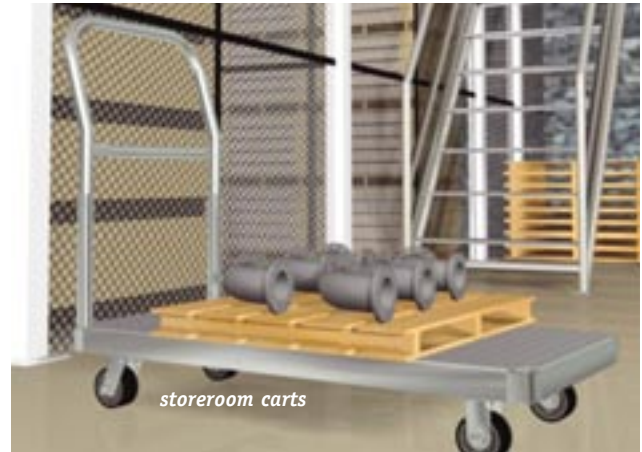

storeroom carts

1 — Select a finish color.

2 — Place 2-digit color code at end of stock no.

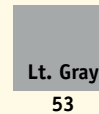
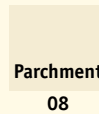

handtrucks

STOREROOM CARTS

Stock No.	Dim. (W/D)	Weight (LBS)	Price
AUC2448	24" x 48"	85	\$222
AUC3048	30" x 48"	100	\$232
AUC3060	30" x 60"	115	\$324
AUC3660	36" x 60"	135	\$335
AUC3672	36" x 72"	155	\$350

BUSINESS GROUP REPRESENTATIVES

■ **Clothing & Textiles**

Dan Hall
Phone: 978 796-3344
E-mail: dhall@central.unicor.gov

■ **Electronics**

John Obremski
Phone: 202 305-3738
E-mail: jobremski@central.unicor.gov

■ **Fleet Management/
Vehicular Components**

Ken Kaz
Phone: 202 305-7312
E-mail: kkaz@central.unicor.gov

■ **Graphics**

Abe Burgos
Phone: 202 305-3752
E-mail: aburgos@central.unicor.gov

■ **Industrial Products**

Ray Evans
Phone: 202 305-3707
E-mail: revans@central.unicor.gov

■ **Office Furniture**

Dennis Merrion
Phone: 202 305-7294
E-mail: dmerrion@central.unicor.gov

■ **Recycling (Computer/Electronic)**

Larry Novicky
Phone: 202 305-3732
E-mail: lnovicky@central.unicor.gov

■ **Services and Distribution**

Frank Hurst
Phone: 202 305-3954
E-mail: fhurst@central.unicor.gov



U.S. Department of Justice

UNICOR

Federal Prison Industries, Inc.

CATMC301

Washington, D.C. 20534

Official Business

Penalty for Private Use \$300

BULK RATE
POSTAGE & FEE
P A I D
FEDERAL PRISON
INDUSTRIES, INC.
Permit No. G-175