

From Philips  
Landscape

Piezoresistor to turn it on in  
sweeping motion  
USB 5v power

Ardiuno  
\$20

Ardiuno

Task light - Len Seid

What you should  
it will keep it  
throughout the day  
mostly programming

Light level  
what it  
Monitors it

No one has  
turn off??

3 variable resistors to determine  
the color of the task light

Replacement Halogen Lamp

Why would you want to do this?

Oh really... WANTS YOUR  
FUCKING

THINK ABOUT RATIONAL

THE USER Real Task light

Tim Brown

Dimensions

Draw this  
production  
Inventory



Model

BS

- \* Cross section
- \* Bounding Box
- \* Product Architecture
- \* Control
- \* Materials, parts list, Process

ERP

ISO

Winfried Schauer  
BS:11/1/1997

Ming Pail  
Self Sealing Part

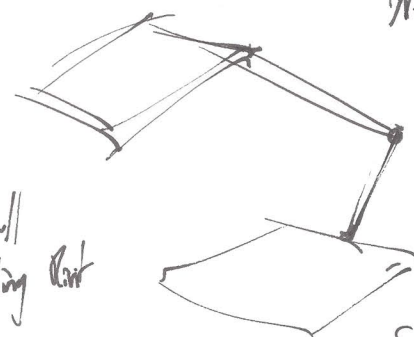

Shoe le  
Khan

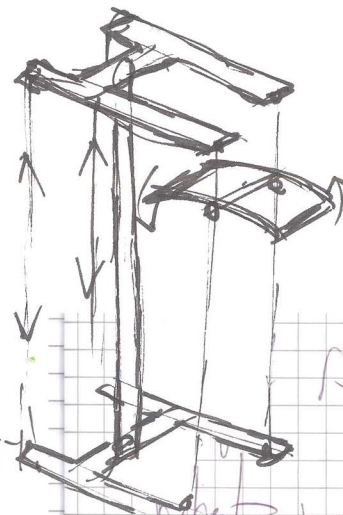

Philips Genious

Rediance LED

real pipe

what we should for

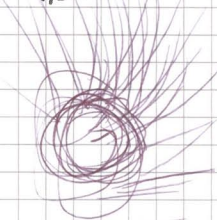
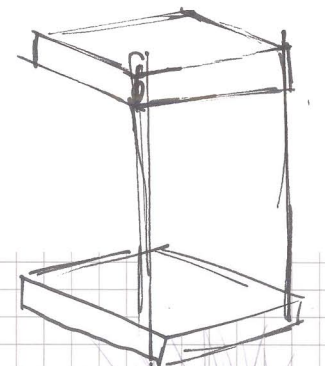
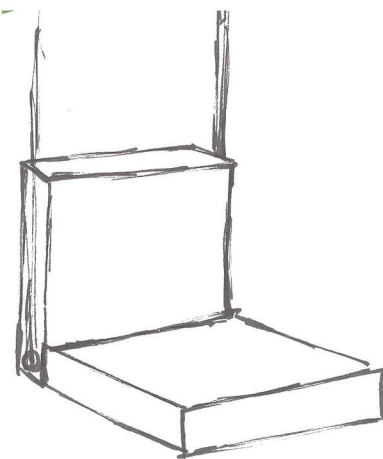

ORMYKIRK  
WIRE COMPANY

Lighting  
SINK

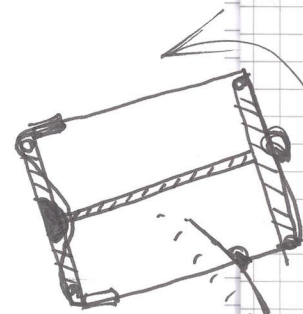
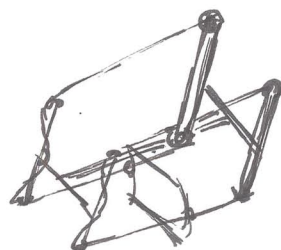

Target Audience

- Creative types that appreciate the quality of light
- Prefer function over form
- Care about British workmanship / Economy
- Work for luxury where materials are sourced and the impact the product has on the environment

Actual Plug can  
reach everyone

- 18+
- Not excessive but somewhat disposable
- environmentally conscious
- kids yes/no City life

what we should for

- Quality of light
- use sustainable techniques / Materials / Processes
- Clear and Concise design
- work the light
- the light is just the start for the light
- the light is the product

CRANE LIKE...?

Power led

More light

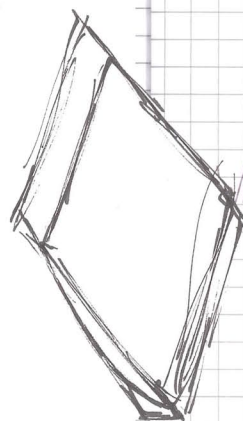
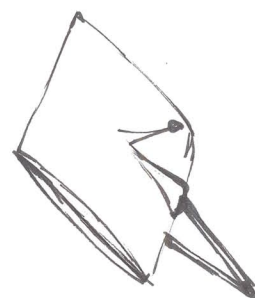

Combine art and technology into  
design, while infusing it with  
emerging cultural