

**J1
TOP VIEW**
SCALE 1:50m

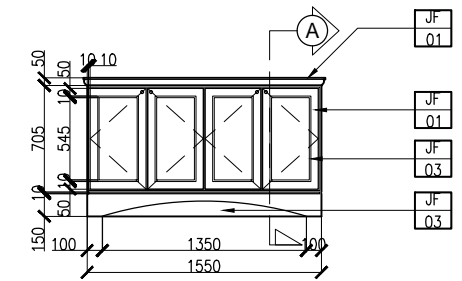

**J1
FRONT VIEW**
SCALE 1:50m

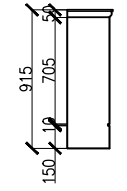

**J1
SIDE VIEW**
SCALE 1:50m

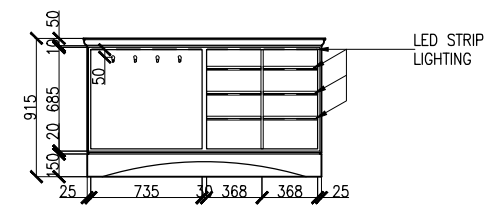

**J1 W/O DOORS
FRONT VIEW**
SCALE 1:50m

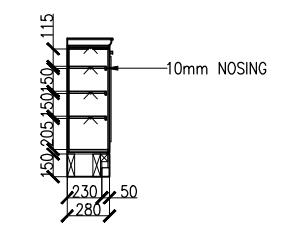

SECTION A
SCALE 1:50m

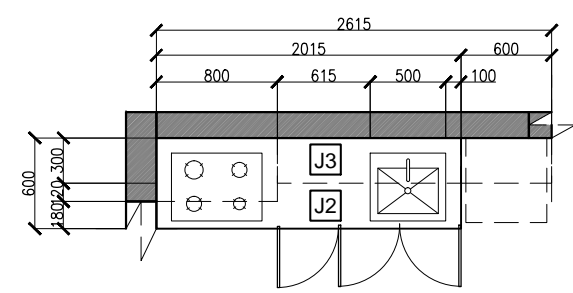

**J2 & J3
TOP VIEW**
SCALE 1:50m

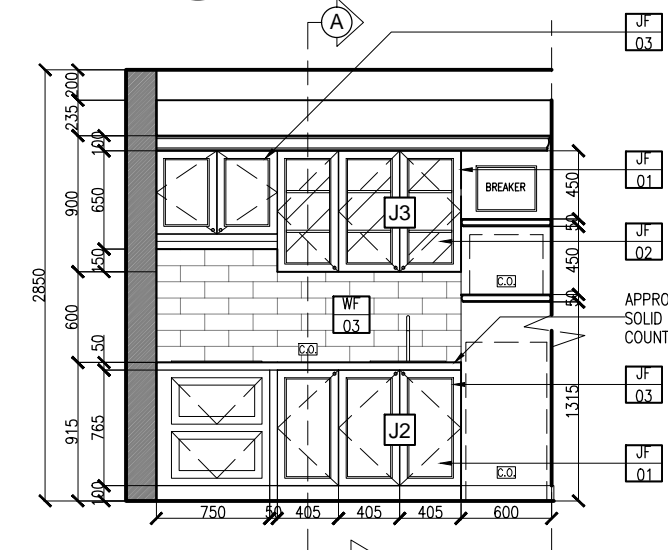

**J2 & J3
FRONT VIEW**
SCALE 1:50m

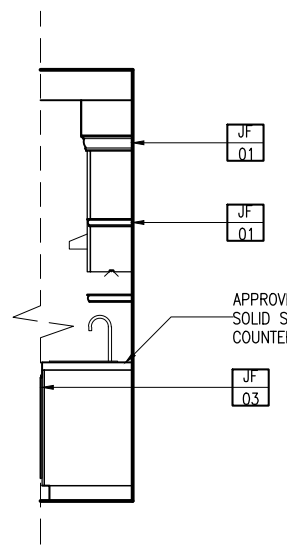

**J2 & J3
SIDE VIEW**
SCALE 1:50m

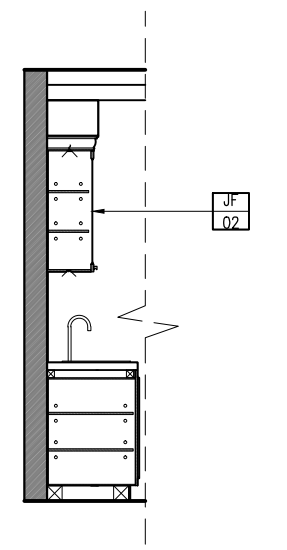

SECTION A
SCALE 1:50m

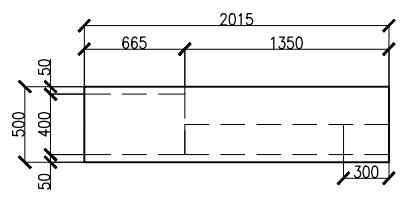

**J4
TOP VIEW**
SCALE 1:50m

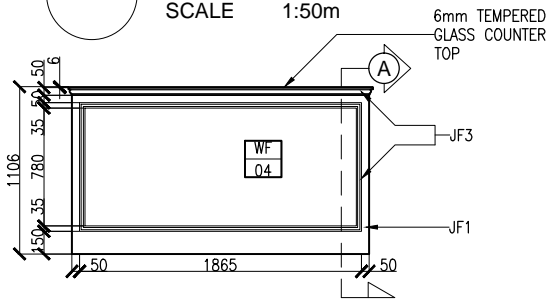

**J4
FRONT VIEW**
SCALE 1:50m

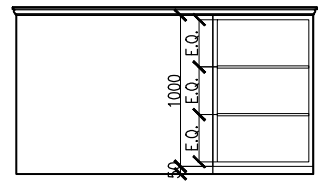

**J4
REAR VIEW**
SCALE 1:50m

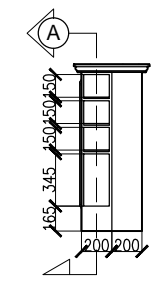

**J4
SIDE VIEW**
SCALE 1:50m

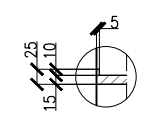

**1.0
SPOT DETAIL**
SCALE 1:12.5m

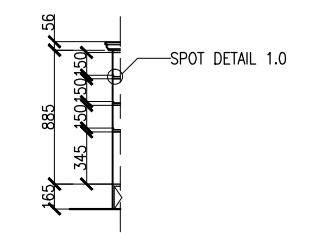

SECTION A
SCALE 1:50m

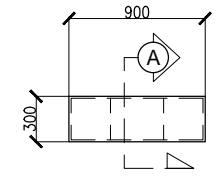

**J5
TOP VIEW**
SCALE 1:50m

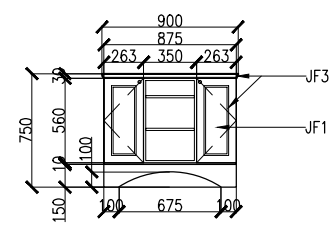

**J5
FRONT VIEW**
SCALE 1:50m

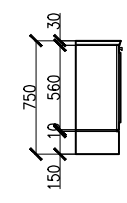

**J5
SIDE VIEW**
SCALE 1:50m

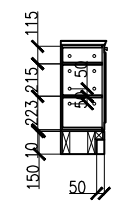

SECTION A
SCALE 1:50m



IDR. DOROTHY TAN
SAN JUAN

PROJECT TITLE:
STUDIO UNIT

OWNER:
MA. KATRINA C. DE RIVERA

ADDRESS:
**18H MORGAN SUITES EXECUTIVE
RESIDENCES FLORENCE WAY 1634
MCKINLEY HILL, TAGUIG, METRO MANILA**

SHEET CONTENTS:
JOINERY DETAIL OF J1-J5

DESIGNED BY:
D. TAN

COORDINATED BY:
D. TAN

SCALE:
1:50m

DATE:
2017-02-01

DATE PRINTED:
2017-02-04

SHEET NO.
I-103