

ANASTASSIA



ASTAPOVA

Anastassia Astapova Designs

Designer : Anastassia Astapova

Date : April 31, 2016

Season : Spring/Summer 2017

Collection : Order Project

Style # : OPSS17D01

Size Range: 10

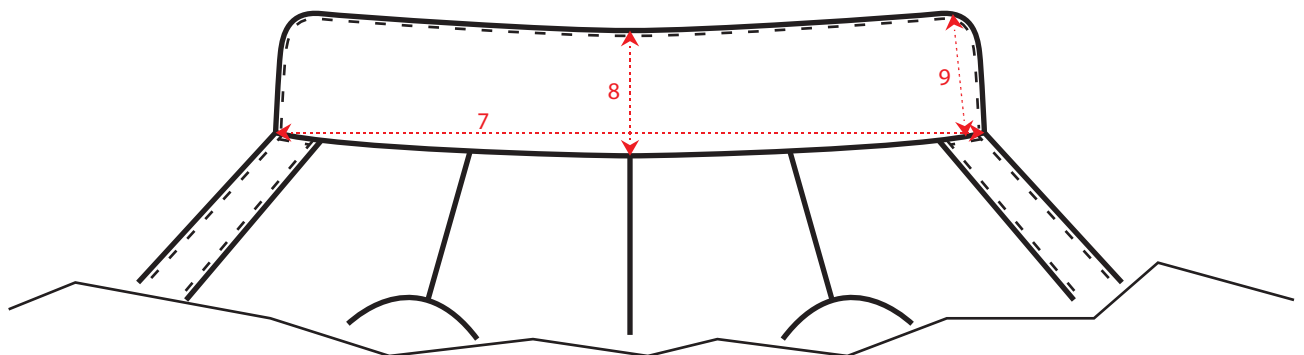
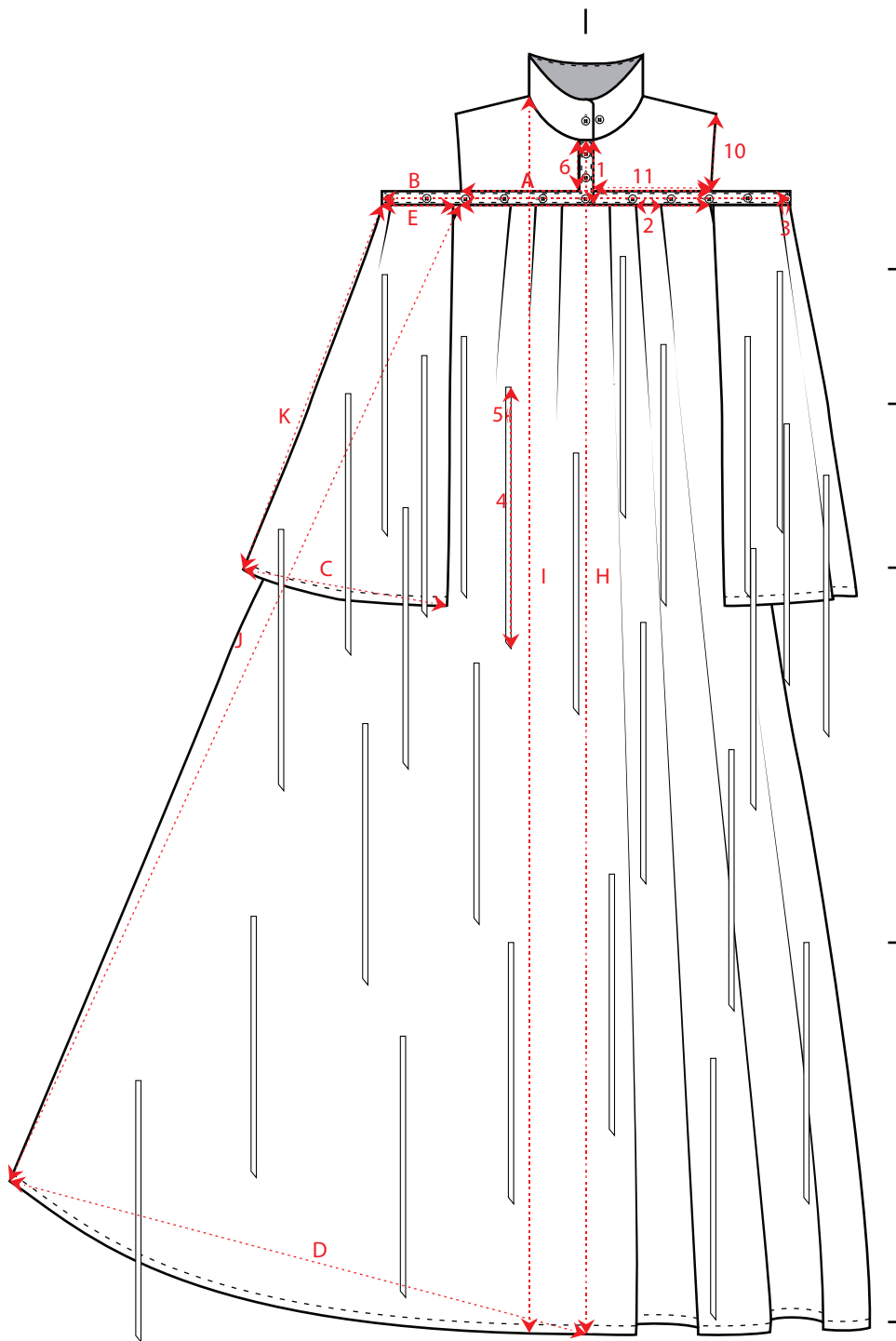
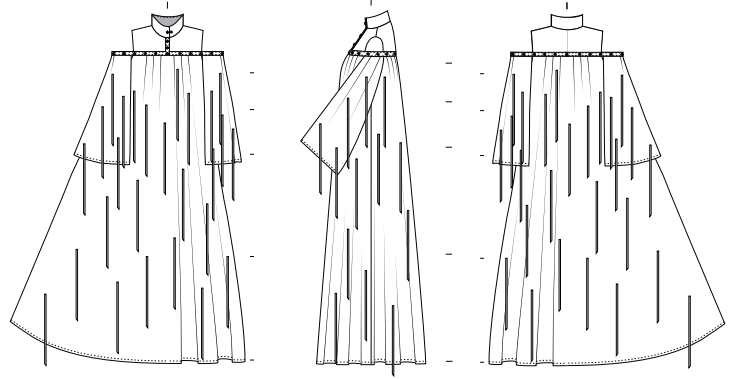

ANASTASSIA



ASTAPOVA

Anastassia Astapova Designs

Designer : Anastassia Astapova

Date : April 31, 2016

Season : Spring/Summer 2017

Collection : Order Project

Style # : OPSS17D01

Size Range: 10

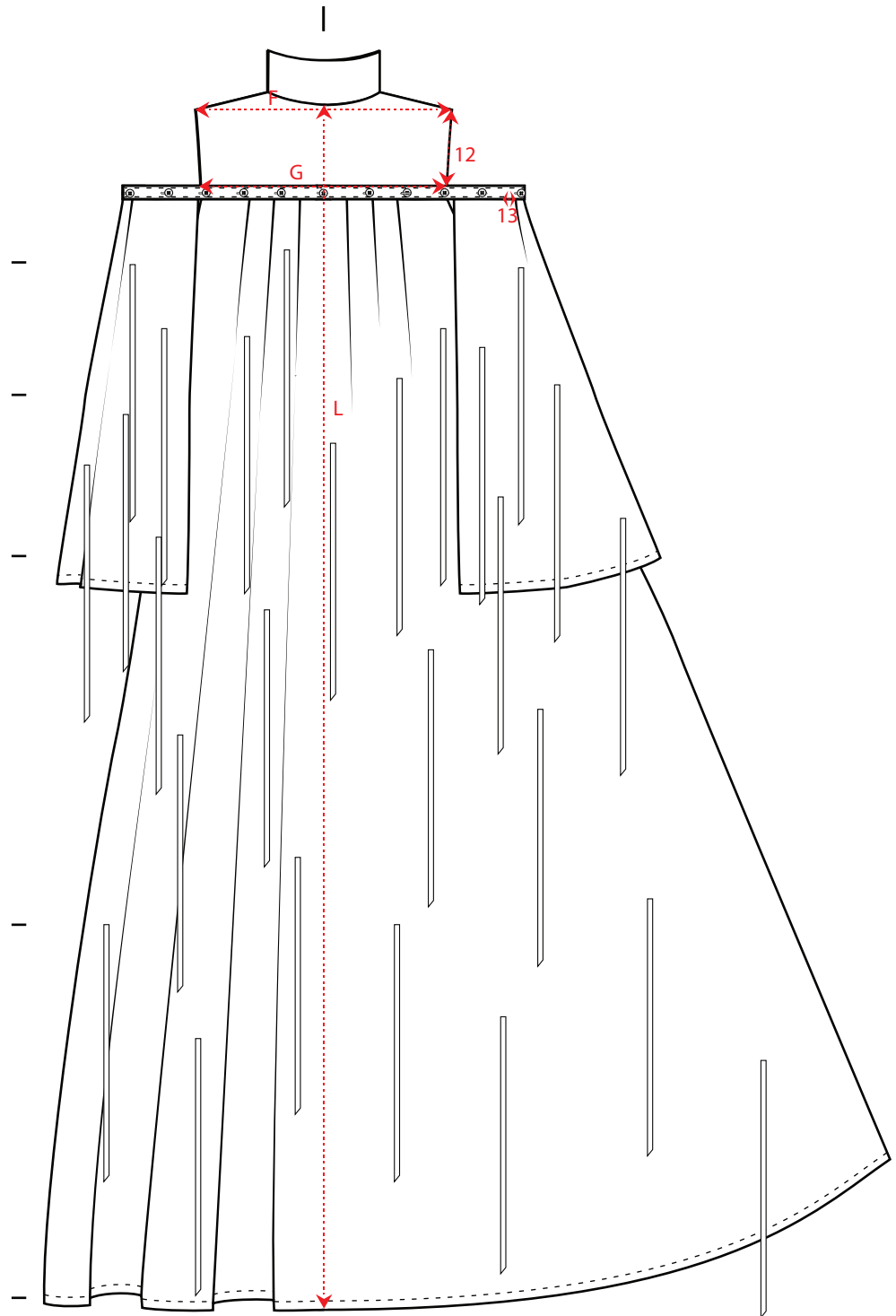
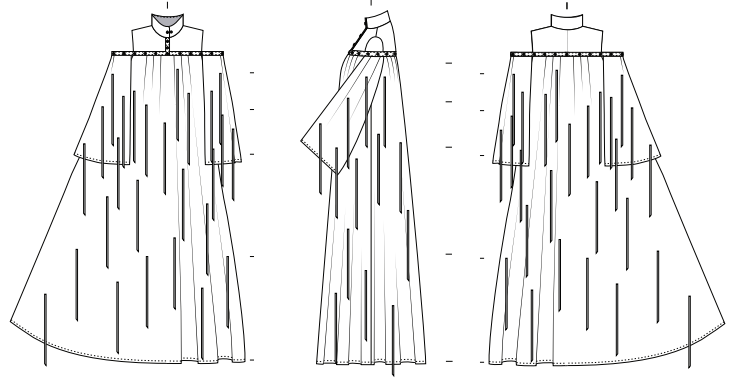

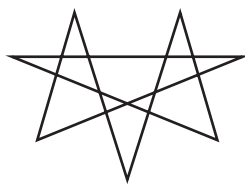

Anastassia Astapova Designs

Designer : Anastassia Astapova

Date : April 31, 2016

Season : Spring/Summer 2017

Collection : Order Project

Style # : OPSS17D01

Size Range: 10

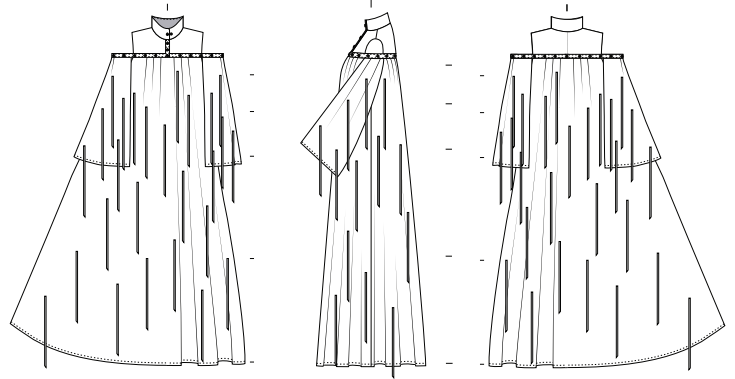

	Point of Measure	How To Measure	Size 10 (cm)
A	Front yoke bottom width	Edge to Edge	56
B	Horizontal plaquet width	Edge to Edge	28
C	Sleeve bottom width	Edge to Edge	35
D	Bottom hem width	Bottom hem folded in 2 at center front, edge to edge	80
E	Sleeve top width	Edge to Edge	15
F	Backshoulder width	Edge to Edge	11
G	Back yoke bottom width	Edge to Edge	30
H	Center front length	Center front from collar to hem, seam to edge	142
I	Total length	HSP to bottom hem, edge to edge	146
J	Side seam	Top of plaquet to hem, edge to dge	120
K	Sleeve length	Top of plaquet to hem, edge to dge	58

	Point of Measure	How To Measure	Size 10 (cm)
1	Center front plaquet length	Seam to edge	12
2	Dress pleat distance / depth	Edge to edge of pleat	4
3	Sleeve pleat distance	Edge to edge of pleat	2
4	Tie legth	Edge to edge	30
5	Tie width	Edge to edge	1
6	Center front yoke length	Seam to seam	3
7	Collar width	Edge to edge	42
8	Center back collar length	Edge to edge	5
9	Center front collar length	Edge to edge 1.5 cm from side edge	5
10	Front yoke sleeve length	Seam to edge	17
11	Yoke front bottom width	From plaquet, seam to edge	12.5
12	Back yoke sleeve length	Seam to edge	19
13	Sleeve pleat depth	From inside edge to outside edge	3