

- WATER BOTTLES, LUNCH IN SEPERATE COMPARTMENT
- KEEP OIL AND TOOLS IN SEPERATE POCKETS

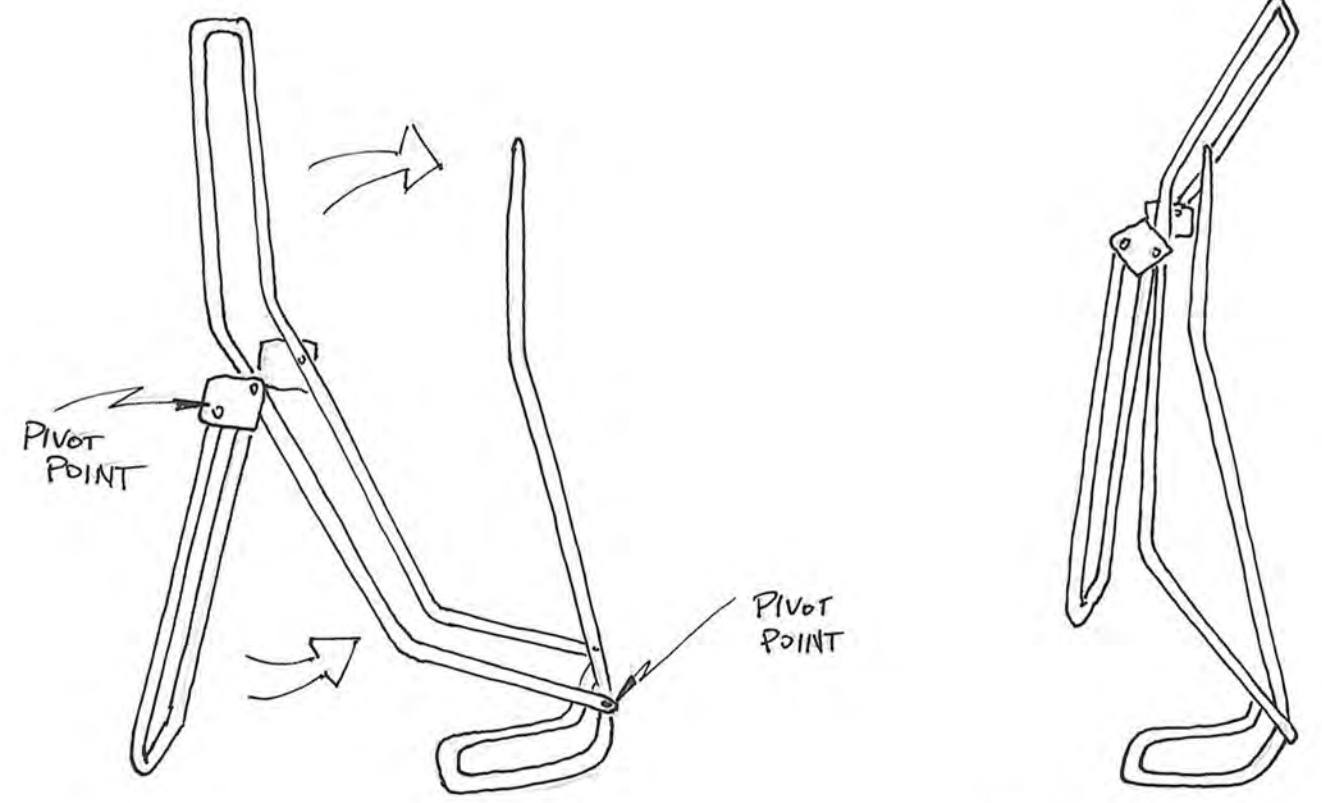

- FRAME NEED TO THIS EXT
- WITH POINT O
- PACK WILL COMPACT E
- STOWED A
- DURING TI

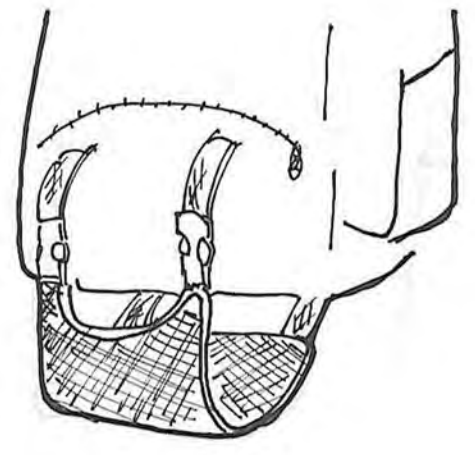

◦ BE ABLE TO REACH AROUND AND DISCONNECT BUCKLES WHILE PACK IS STILL ON

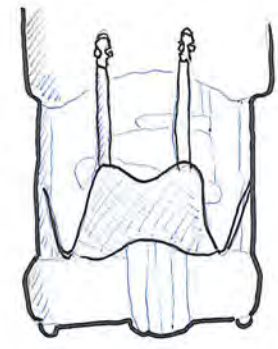

◦ STRAPS LOOP UNDER HANDLE AND TIGHTEN TO HOLD CHAINSAW IN PLACE

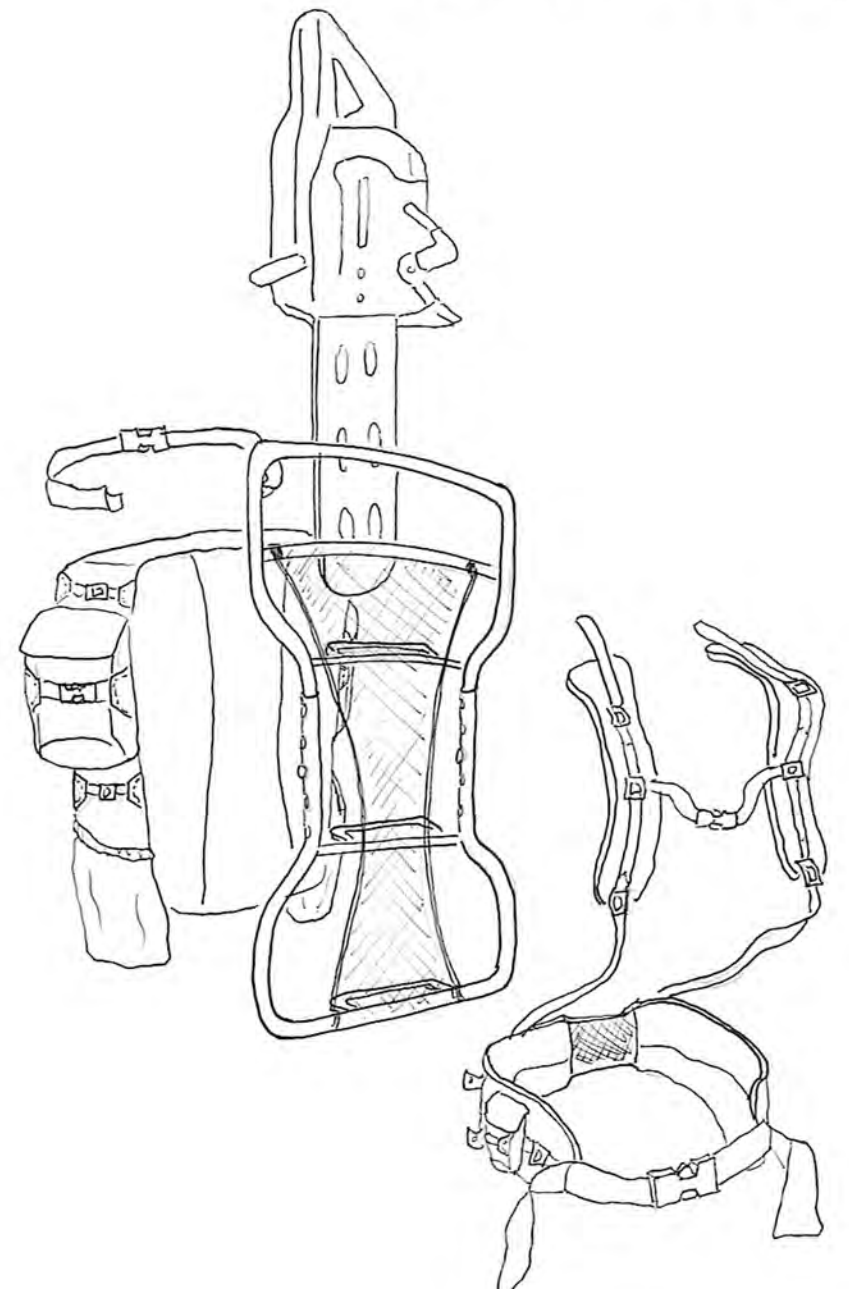
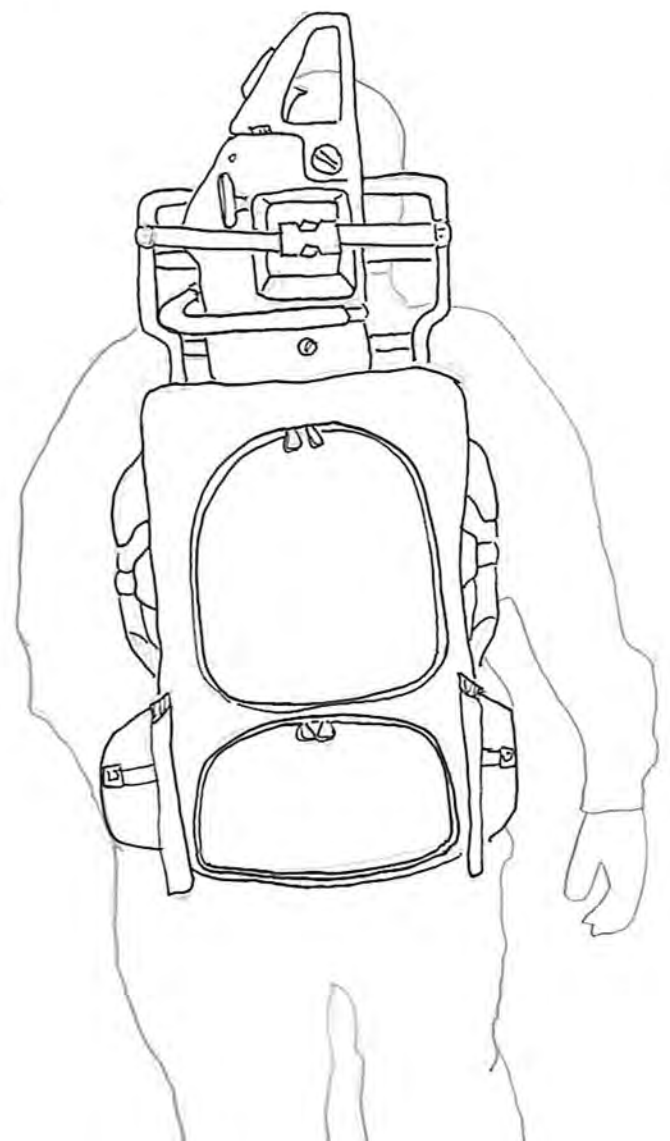
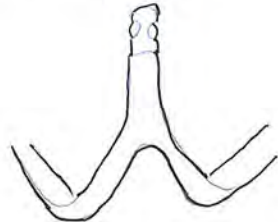
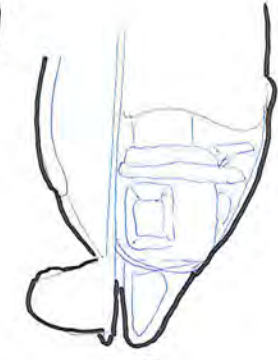
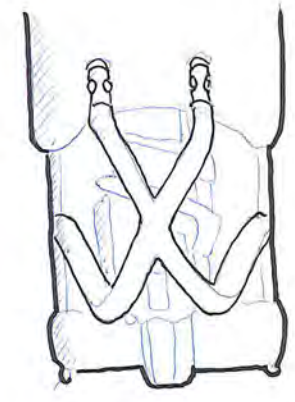

◦ STRAP USED TO HOLD CHAINSAW IN PLACE ATTACHED BY BUCKLES

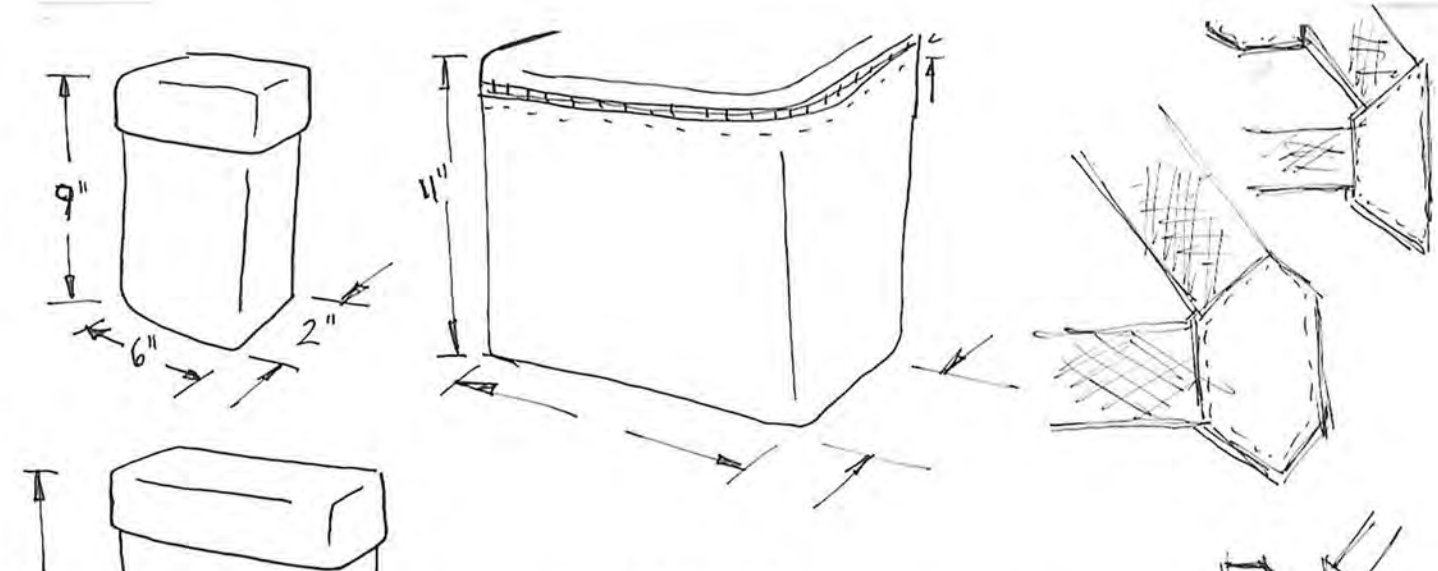
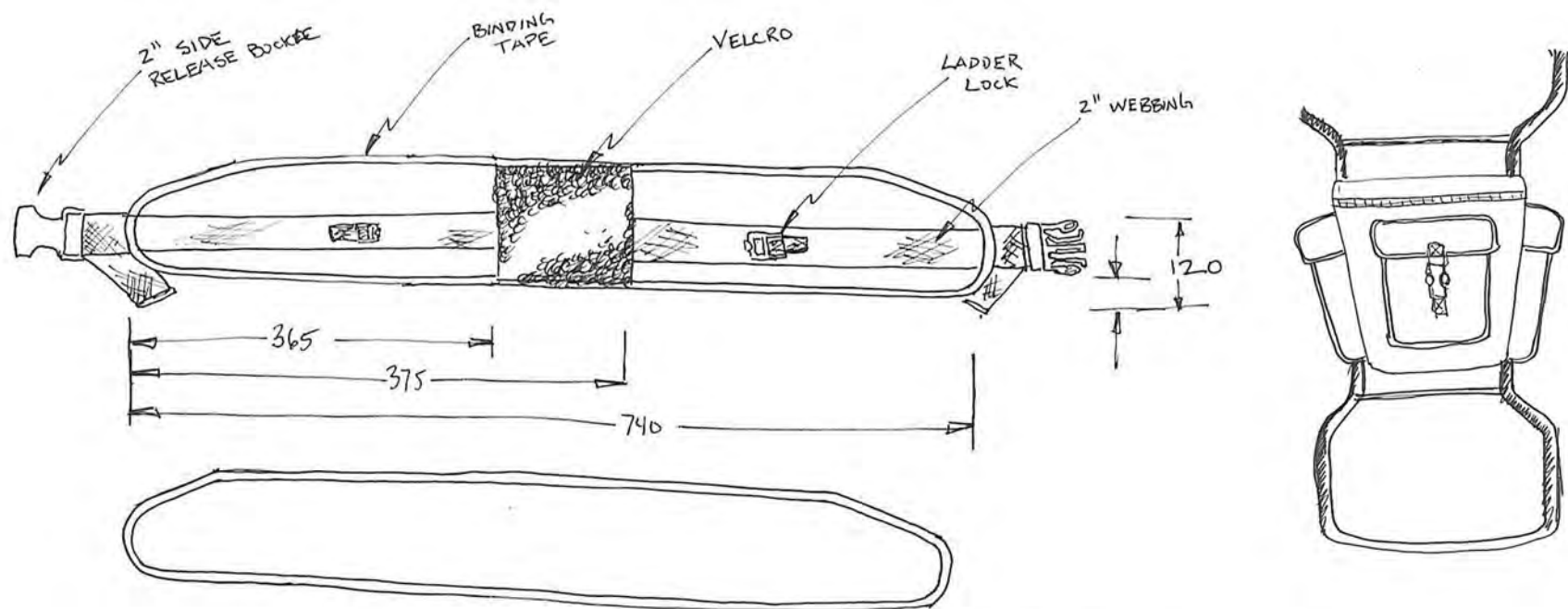

NOTE: ADD 1/2" SEAM ALLOWANCE

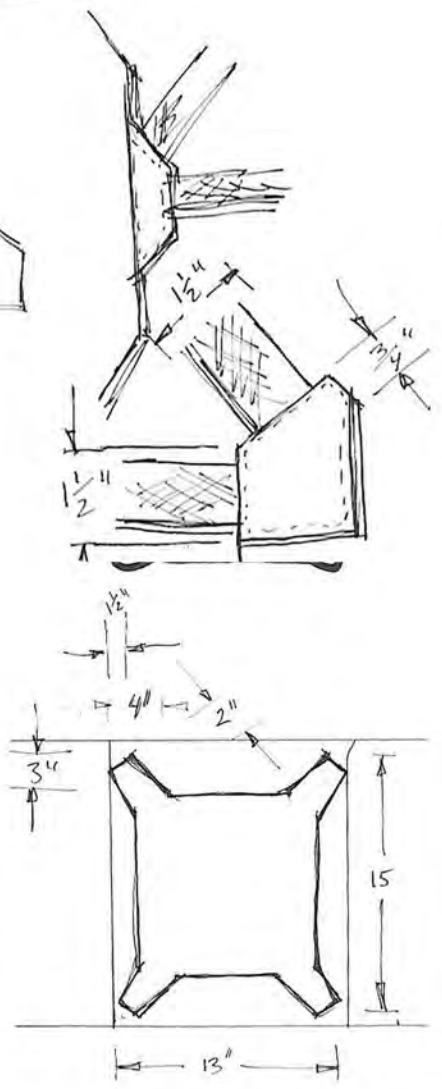
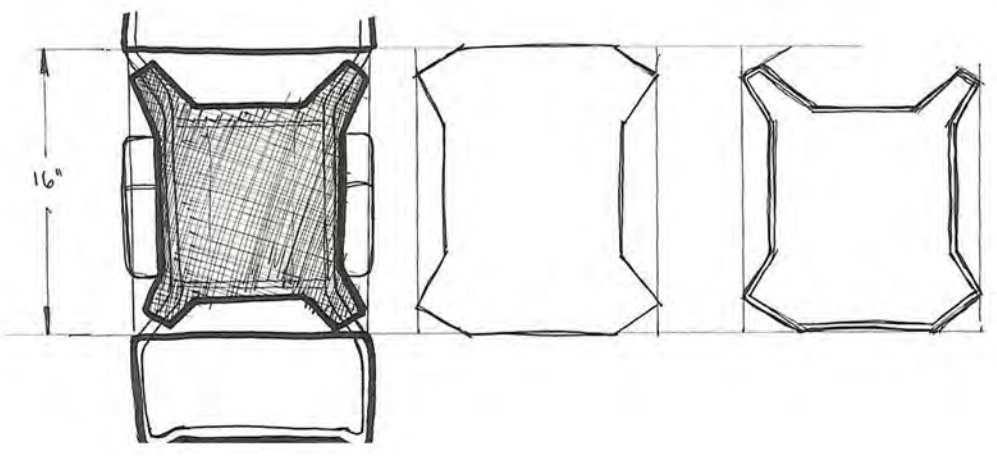
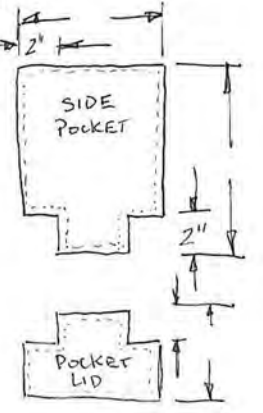
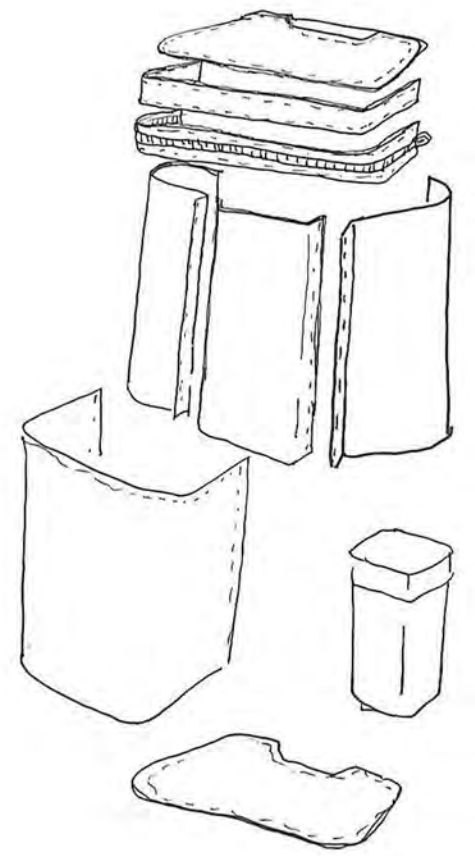
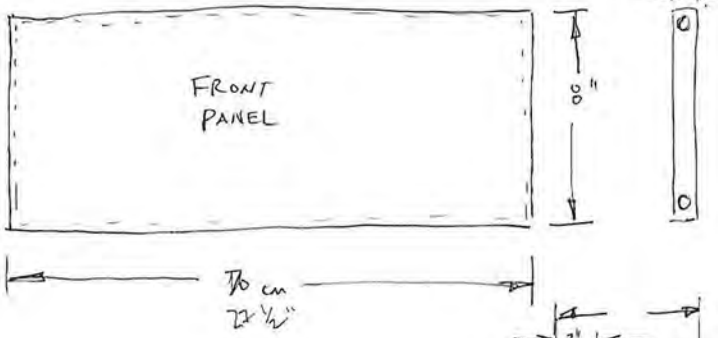
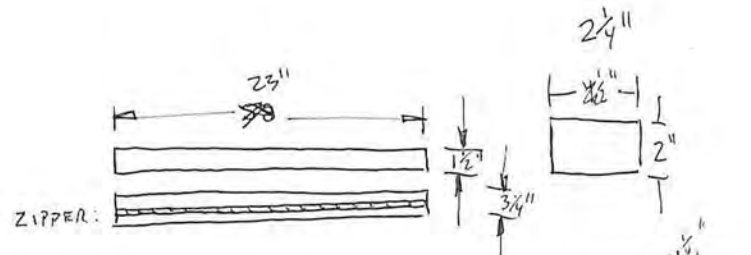
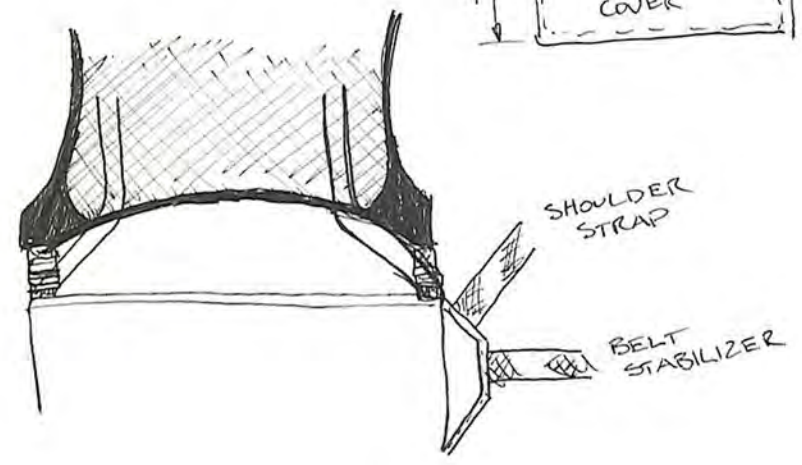
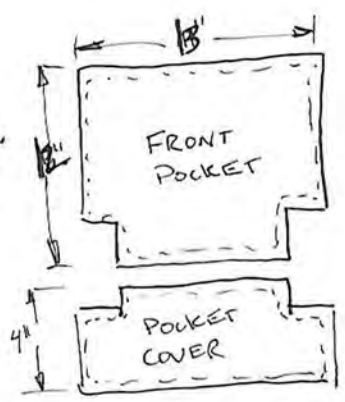
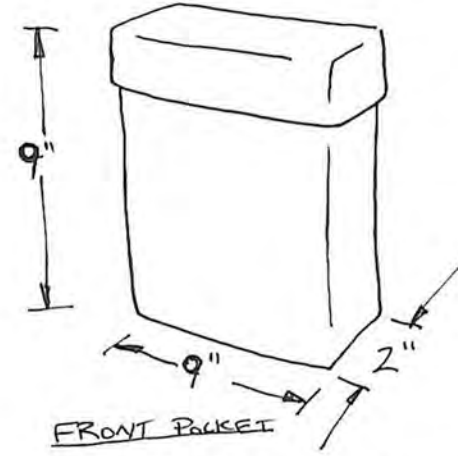
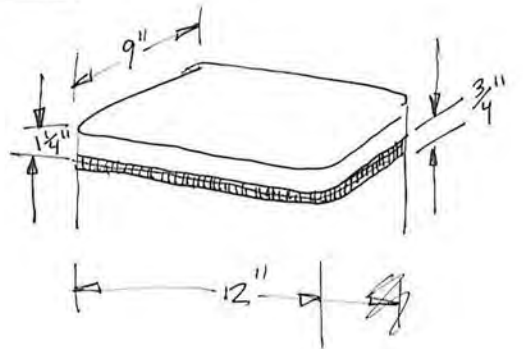
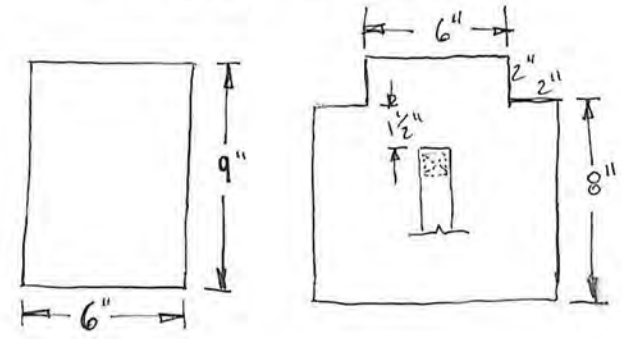

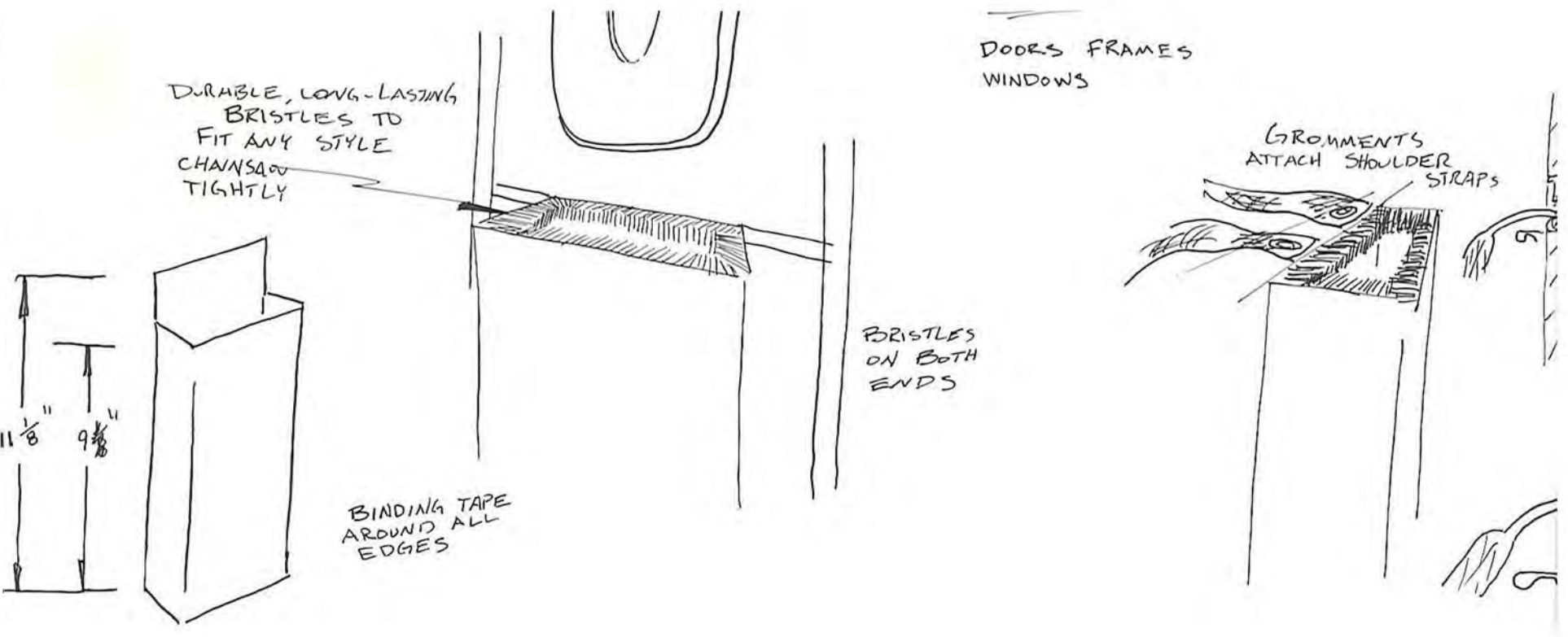
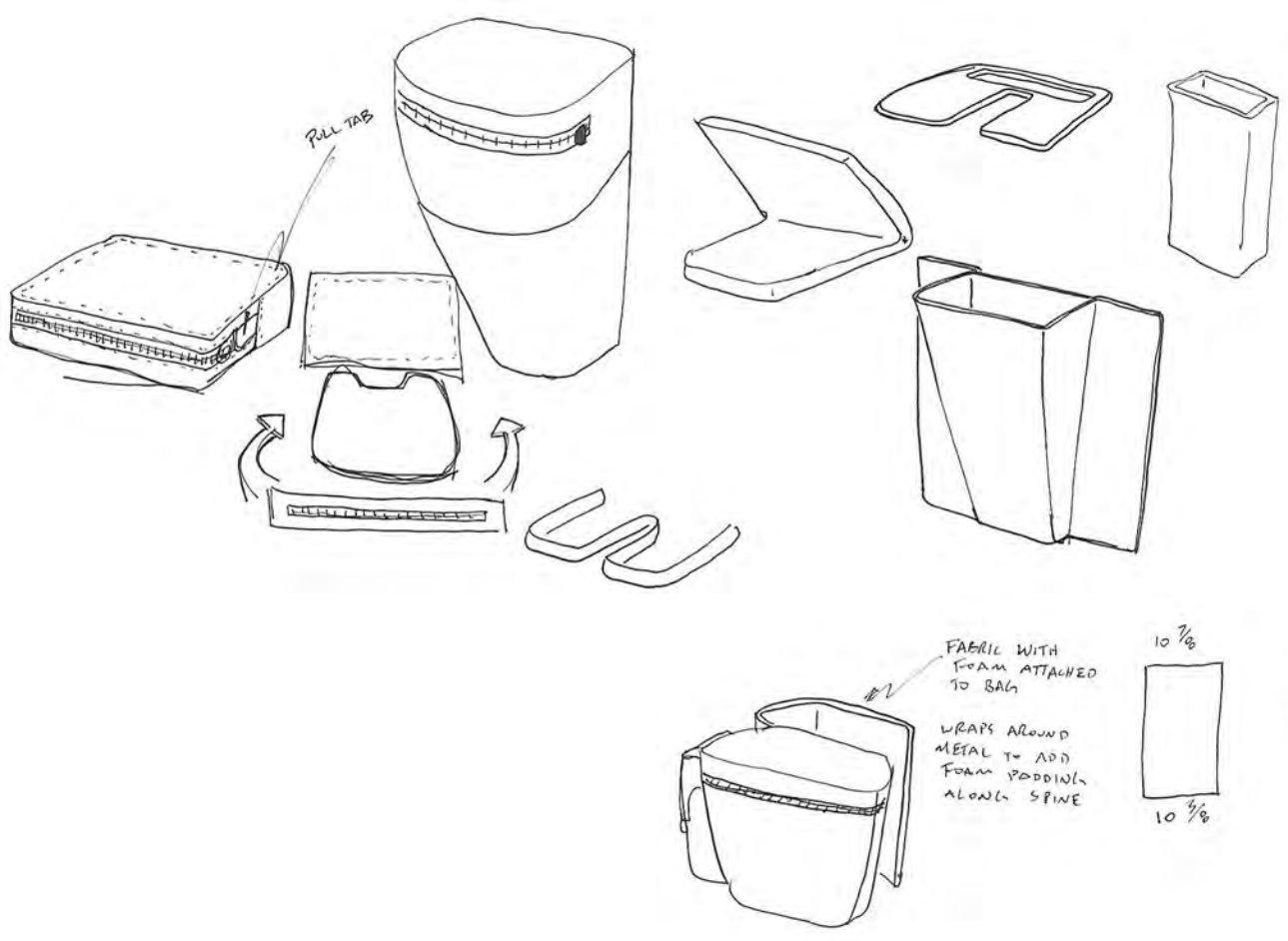
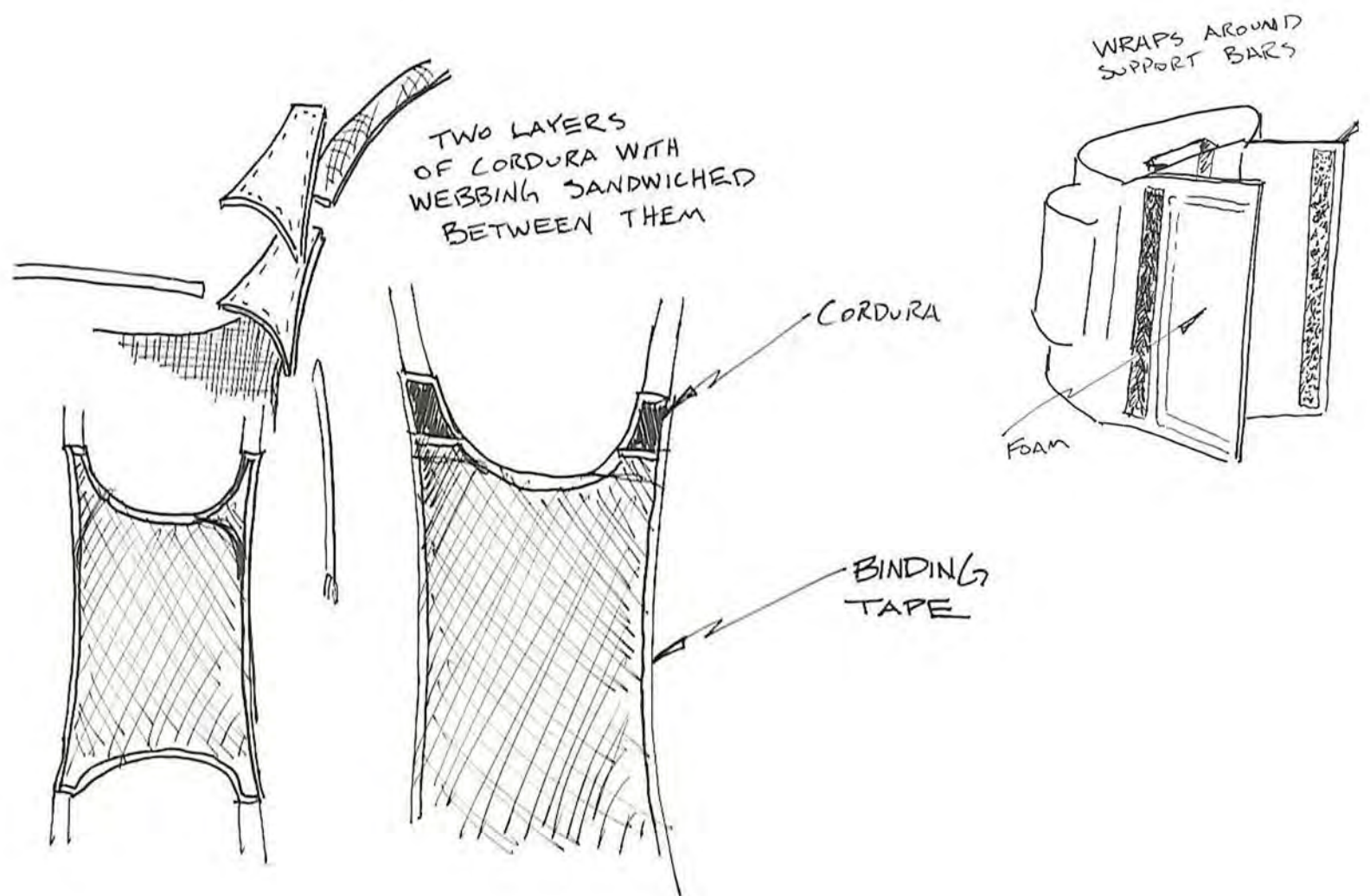
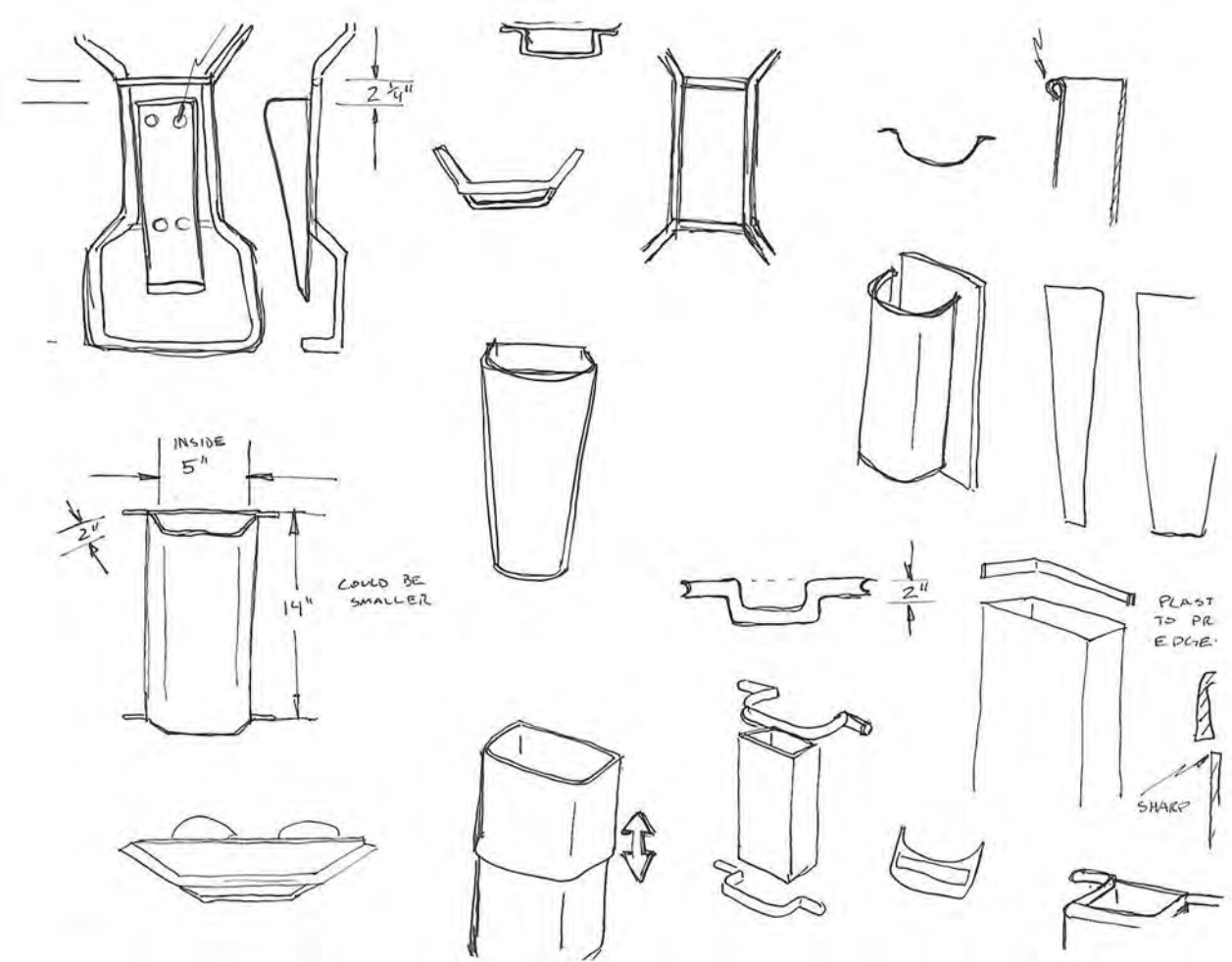

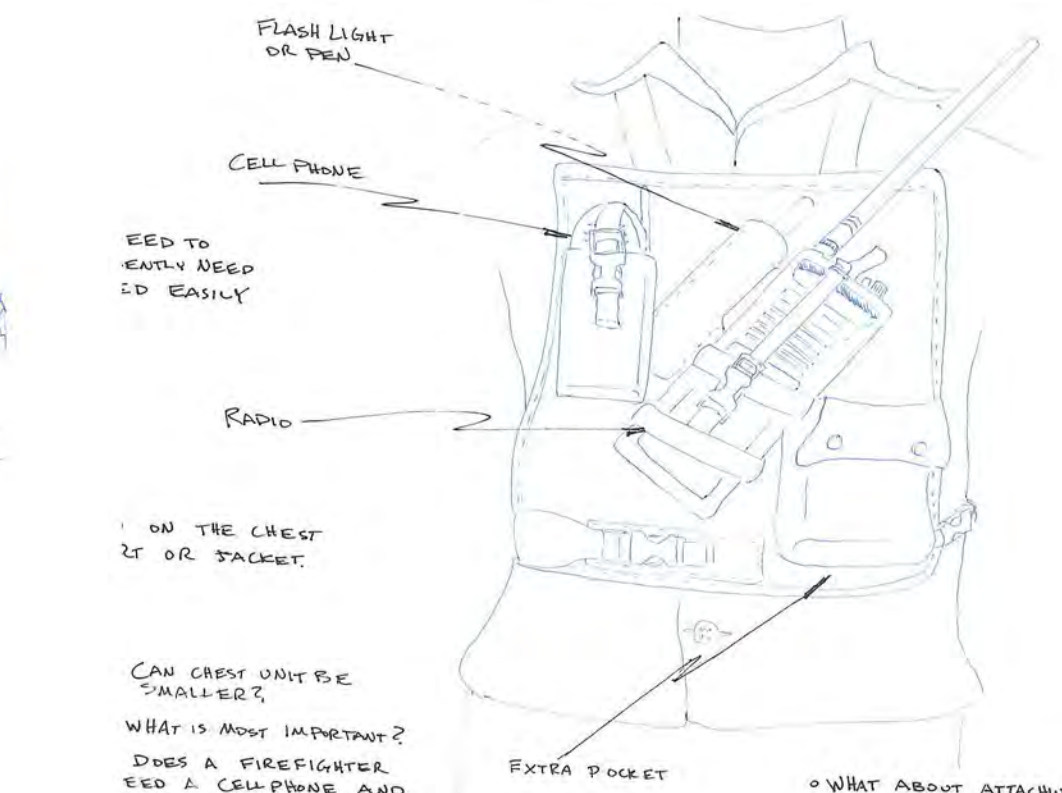
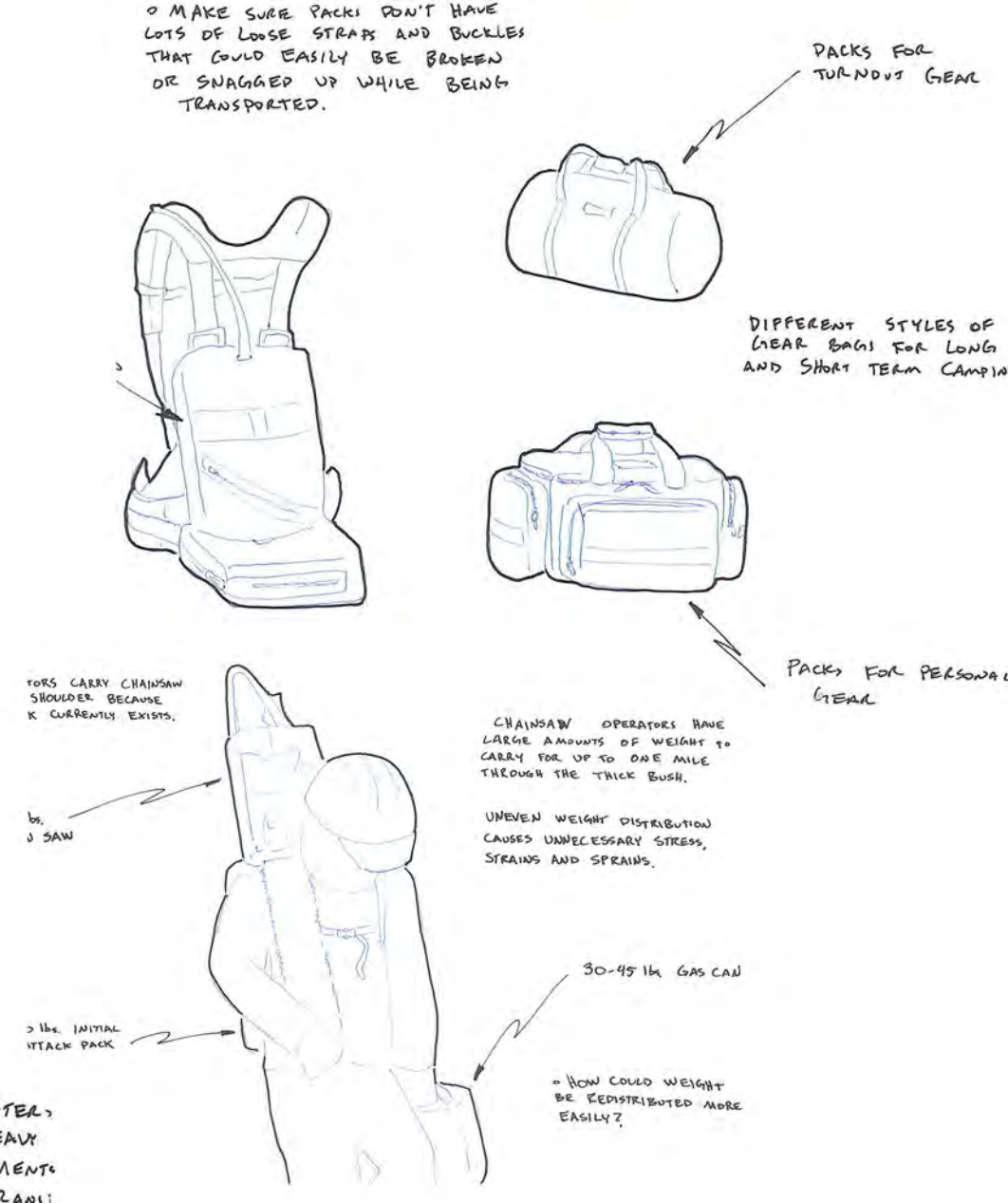
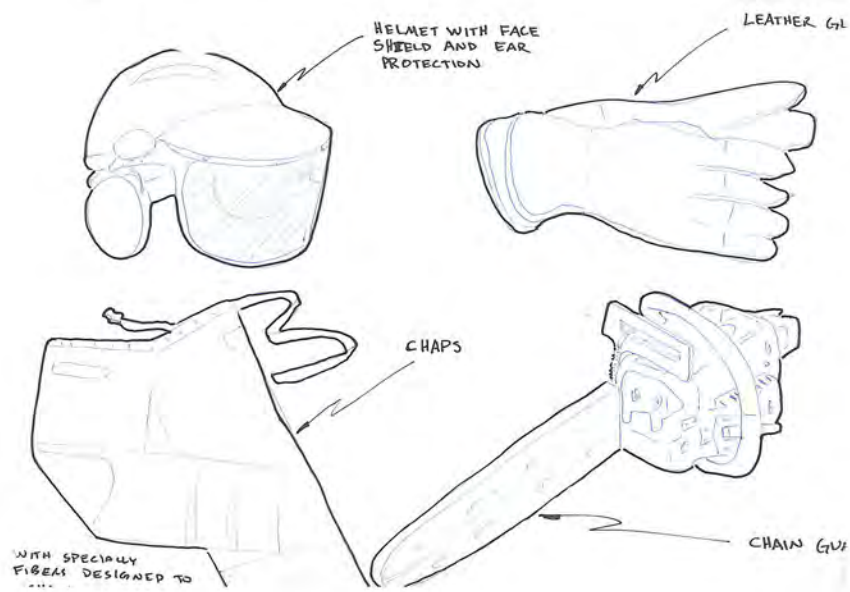
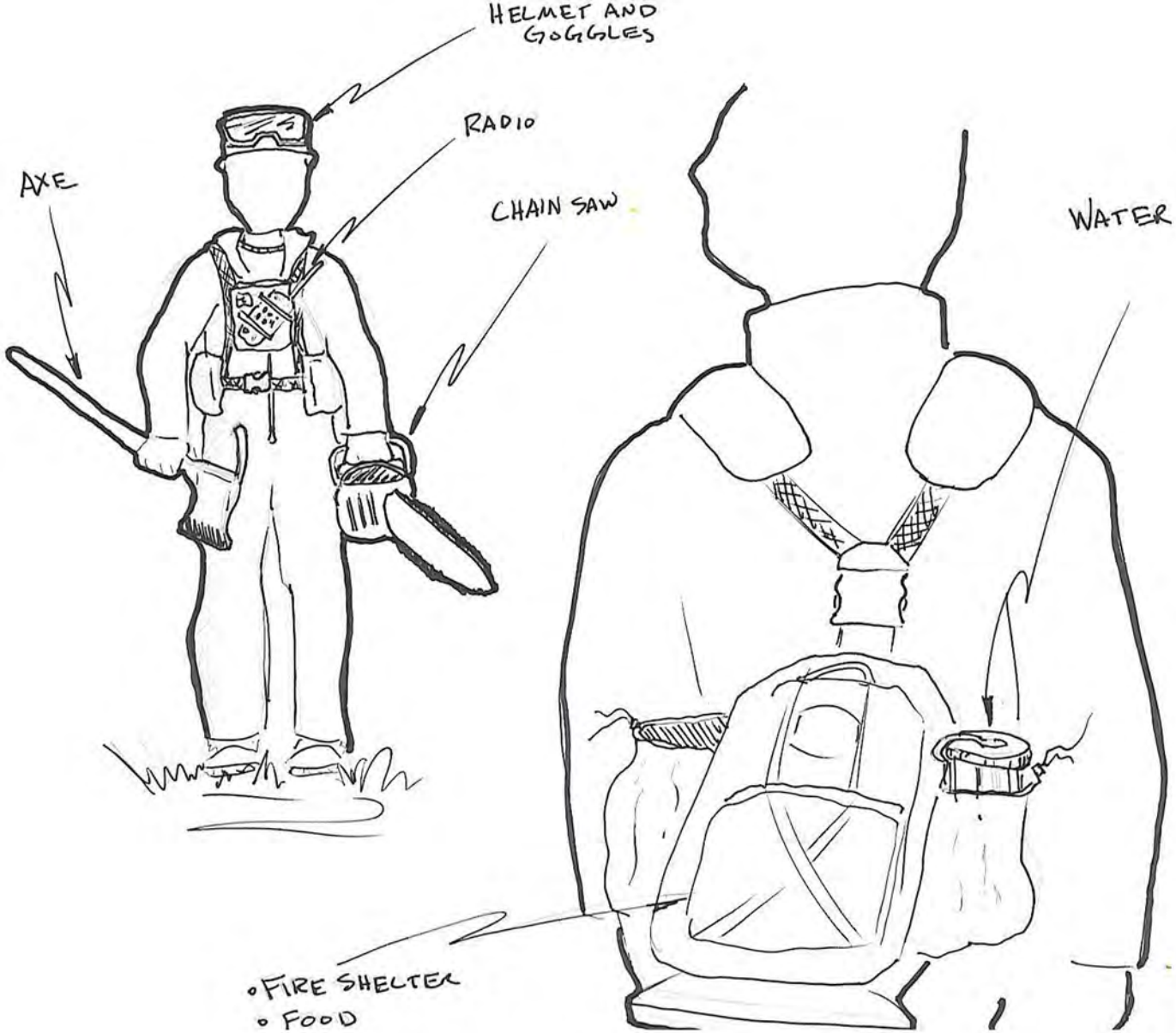

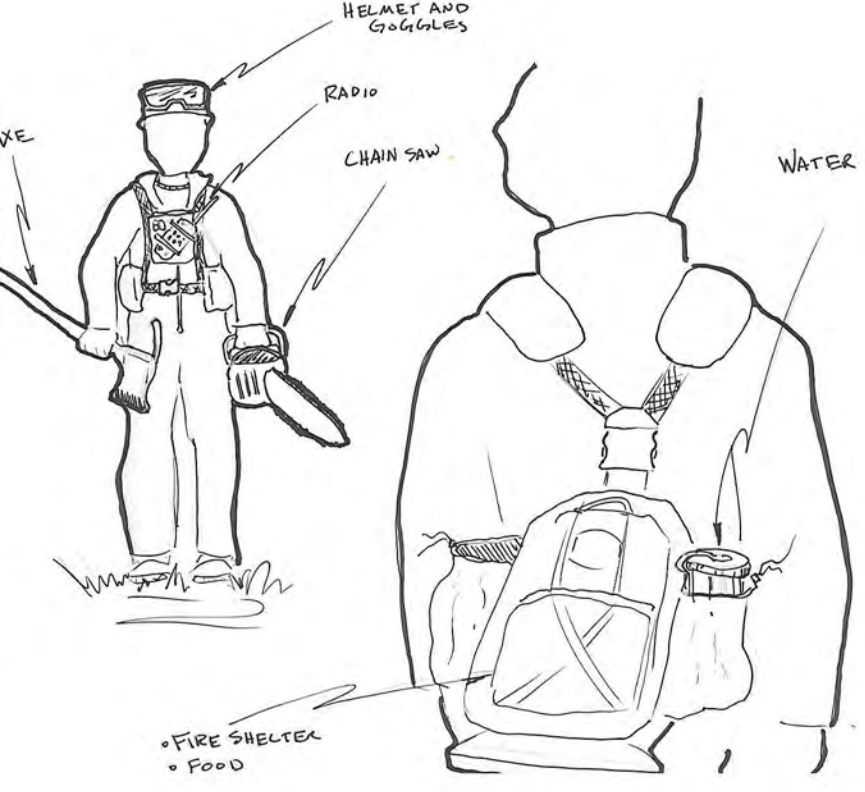

HOW IS EQUIPMENT ORGANIZED AND TRANSPORTED?

PACKS ARE NOT ALWAYS HANDLED WITH CARE AND ITEMS ARE OFTEN BROKEN OR DAMAGED.

BACK CREWS RAPP...
REMOTE AREAS.

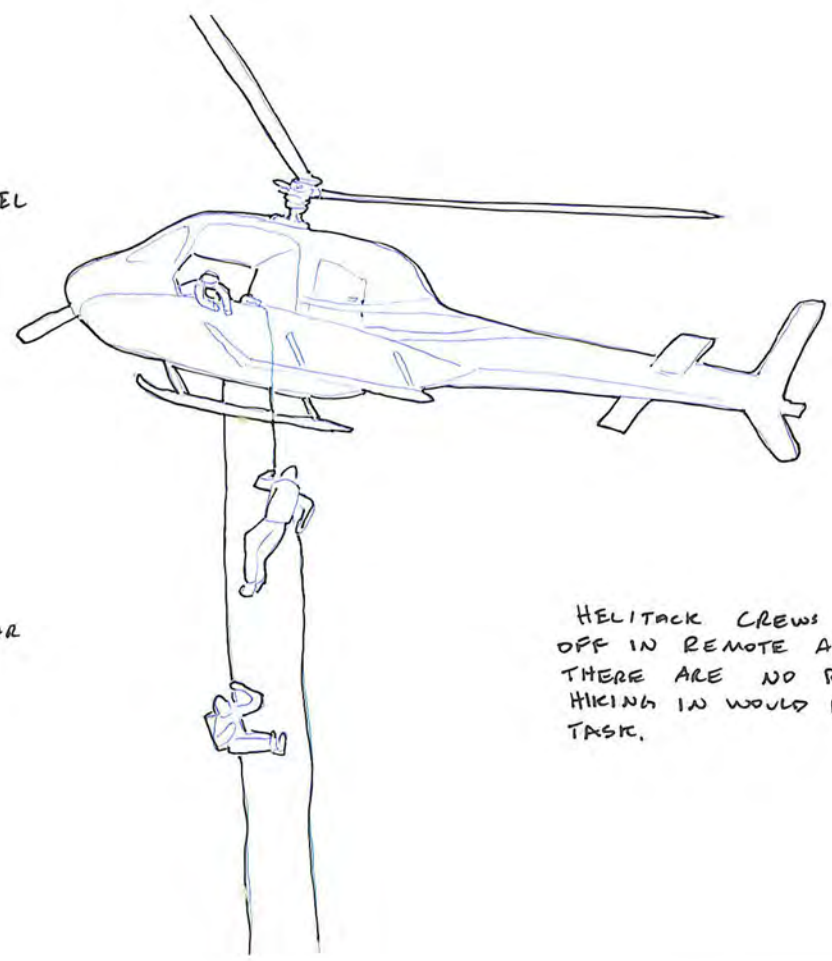

THINK ABOUT GEAR
PORT.

HELITACK CREWS ARE DROPPED OFF IN REMOTE AREAS WHERE THERE ARE NO ROADS AND HIKING IN WOULD BE A DAUNTING TASK.

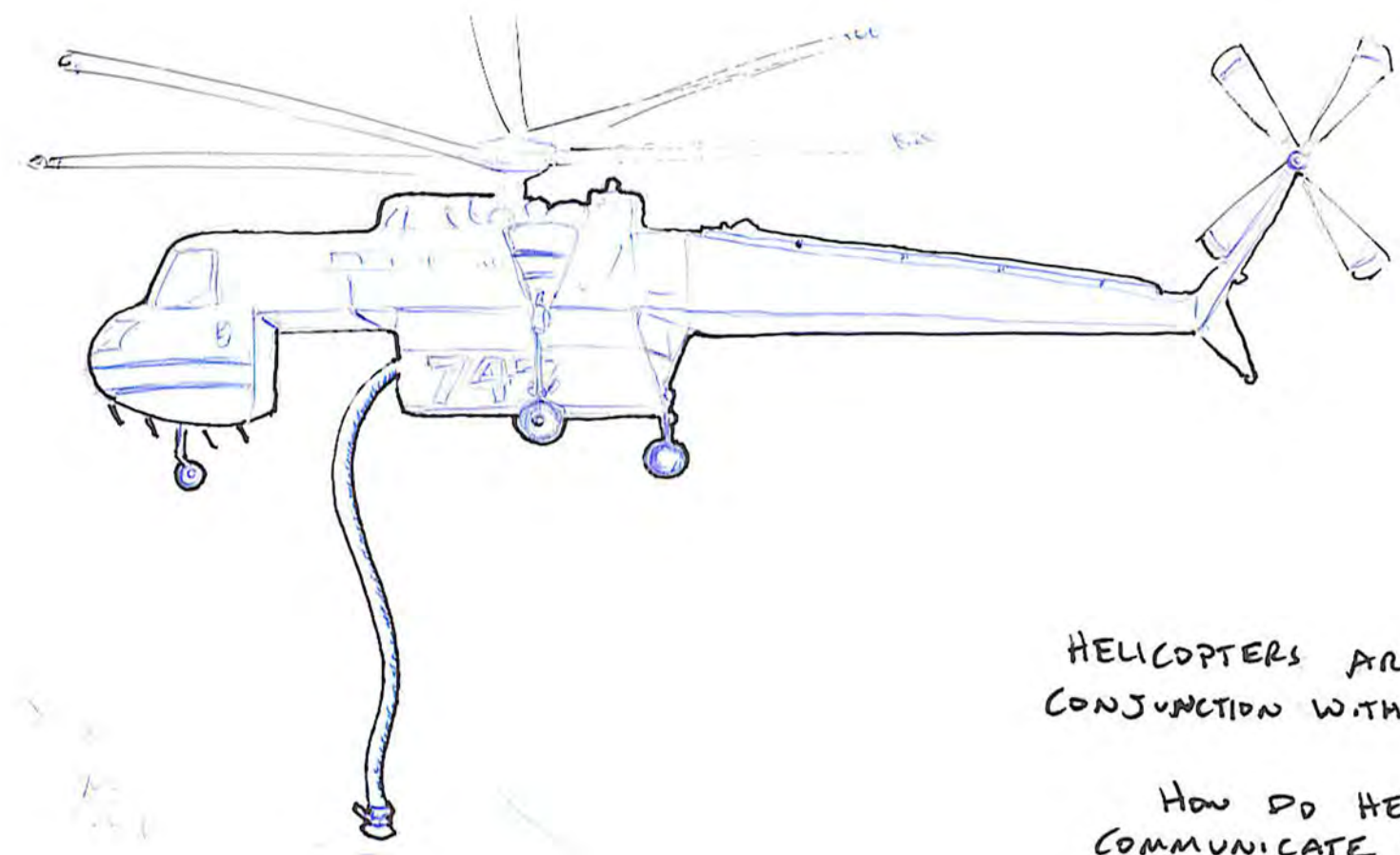

HELICOPTERS ARE USED IN CONJUNCTION WITH GROUND CREWS

HOW DO HELICOPTERS COMMUNICATE WITH GROUND CREWS?