



IGNASI CABRISSES
ARCHITECTURE HMI



// PERSONAL DATA

name / **IGNASI CABRISSES**

date of birth / 08.05.1974 in Barcelona

adress / 47 AV CLAUDE NICOLAS LEDOUX

78114 MAGNY_LES_HAMEAUX

[FRANCE]

mobile / +33.6.95.24.50.50

e_mail / icabrisse@gmail.com

// ACADEMIC EDUCATION

Industrial Designer at ELISAVA [1992_96]

Design Credit at SOUTHAMPTON UNIVERSITY [1996]

Master in Transportation Design at ELISAVA [1998_99]

// DIGITAL SKILLS

Alias AUTODESK

VRED AUTODESK

Photoshop ADOBE

Microsoft Office

// LANGUAGES

Catalan [mother tongue]

Spanish [mother tongue]

French [C level in 2018]

English [TOEIC 795 in 2011]

German [2A level in 2002]

// PROFESSIONAL EXPERIENCE

RENAULT SAS Technocentre October 2011 until October 2021

Design Director / Laurens Van Den Acker

Job post / Studio Chief for Interior Components_Lighting and Strategy

SEAT Diseño CT August 2007 - September 2011

Design Director / Luc Donkerwolke

Job post / Interior Components Lead Designer

ARIANETECH ENGINEERING 2007 [consulting]

Job post / Design consultant

IFR AUTOMOTIVE November 2006 – February 2007 [consulting]

Job post / Design consultant

RENAULT SAS Technocentre May 2006 – July 2007

Design Director / Patick Le Quément

Job post / Alias Designer Modeller

PSA Peugeot Citroën SPCI May 2005 - May 2006

Design Director / Curt Gwin

Job post / Alias Designer Modeller

RENAULT SAS Technocentre Abril 2004 – May 2005

Design Director / Patick Le Quément

Job post / Alias Designer Modeller

PSA Peugeot Citroën SPCI 2002 – 2004

Design Director / Curt Gwin

Job post / Alias Designer Modeller

SEAT Diseño CT 1999 – 2002

Design Director / Walter De Silva

Job post / Interior Components Designer

Cactus Design 1997 – 1998

Design Director / Quim Espona

Job post / Product Designer

Benedito Design 1997

Design Director / Ramon Benedito

Job post / Product Designer

I have worked as professor at the Elisava Design School(1996 – 99)

Decoplastic, s.a. 1996 – 1997

Director / Melquiades Bañon

Job post / Product Designer

Invenio Taller de Disseny 1995 – 1996

Design Director / Paco Escoda

Job post / Product Designer

Bernal/Isern Diseñadores 1995

Design Director / Ramon Isern & Gemma Bernal

Job post / Trainer Designer

CAR MARKER

DESIGN

EXTERIOR
DESIGN

INTERIOR
DESIGN

COLOR
& TRIM

STYLE

ARCHITECTURE HMI

UX/UI

COMPONENTS

INFLUENCE

INNOVATION
CES LAS VEGAS

...

ENGINEERING

SUPPLIERS

ARCHITECTURE HMI DESIGN PROCESS

INFLUENCE

TARGET
BENCH
GOLDEN CAR

ENGINEERING
SUPPLIERS

ENGINEERING
SUPPLIERS

SKILLS

STRATEGY

STRATEGY

STRATEGY
DESIGN
DEVELOPEMENT

DESIGN
DEVELOPEMENT

DESIGN
DEVELOPEMENT

DEVELOPEMENT

DEVELOPEMENT

CONTEXT

01.SCENARIOS

02.DEVELOPEMENT
SCENARIOS CHOICE

03.DEFINITION
COMPONENTS

04.DESIGN
COMPETITION

05.DEVELOPPING
COMPONENTS

06.STRACK

07.VALIDATION
MODELS

BLUEPRINTS
OF SEVERAL
HYPOTHESES

MACROZONNING
ERGONOMICS
INTERACTION MOD

SCREEN FORMATS
STEERING WHEEL
COMMANDS
COMUN PARTS
UX/UI

SKETCHING

ALIAS

FINE TUNNING

METHOD

2D

2D / VR / PHYSICAL BOXES

2D

3D DIGITAL MODELS



RENAULT MEGANE E 2021



//COCKPIT



RENAULT MEGAN-E 2021

//COCKPIT





//RENAULT CLIO





RENAULT NEW CAPTUR 2019



RENAULT CLIO V 2019



RENAULT NEW ZOE 2019

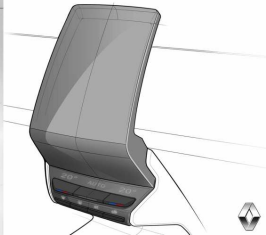
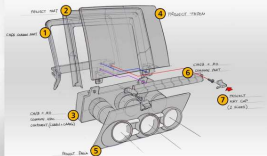
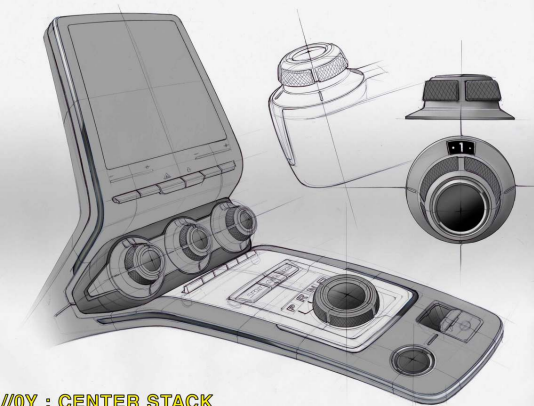



RENAULT NEW CAPTUR 2019



RENAULT CLIO V 2019



RENAULT NEW ZOE 2019

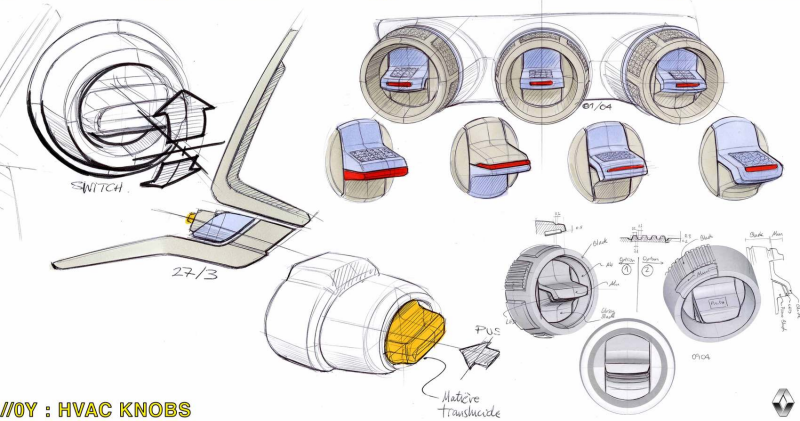

0104 : HVAC KNOBS



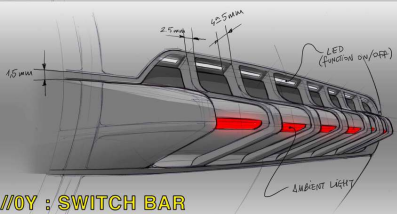
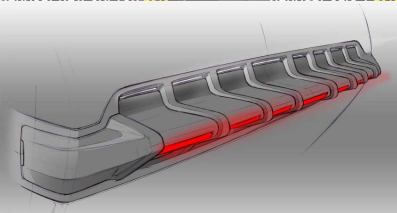

//0Y : SWITCH BAR

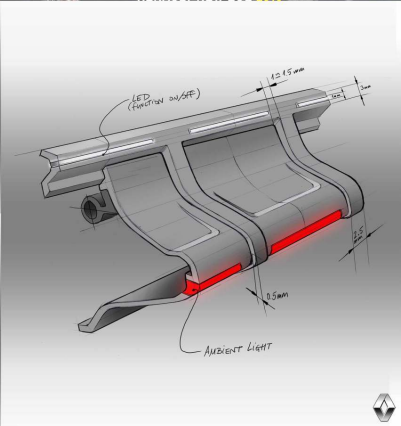



RENAULT NEW CAPTUR 2019



RENAULT CLIO V 2019



RENAULT NEW ZOE 2019



//DOOR PANEL

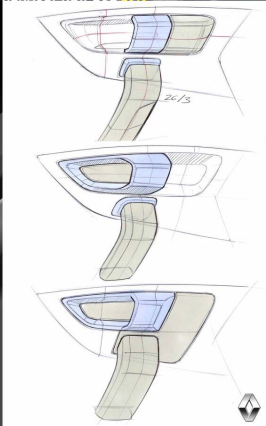

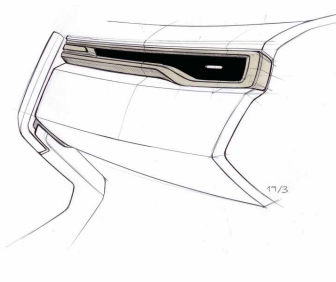
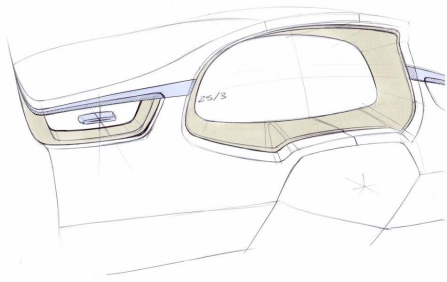

//IP : AIRVENTS & HOOD





//RENAULT TALISMAN





RENAULT TALISMAN 2017



RENAULT MEGANE 2017



RENAULT SCENIC 2017



RENAULT ESPACE 2016

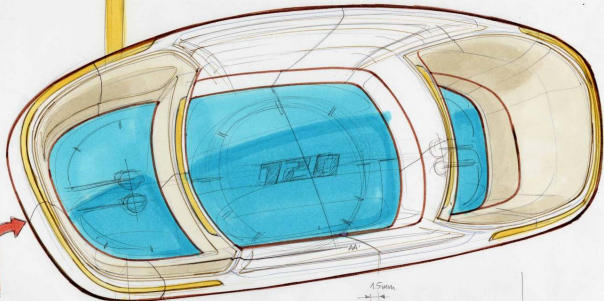

//COCKPIT : CLUSTER



RENAULT TALISMAN 2017



RENAULT MEGANE 2017



RENAULT SCENIC 2017



RENAULT ESPACE 2016



//0Y : CENTER STACK



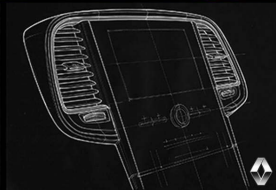
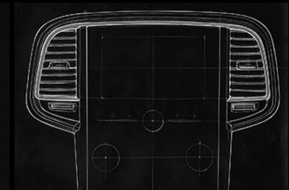



RENAULT TALISMAN 2017



RENAULT MEGANE 2017



RENAULT SCENIC 2017



RENAULT ESPACE 2016

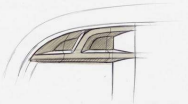
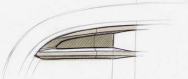
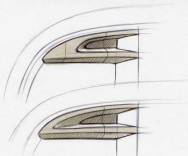
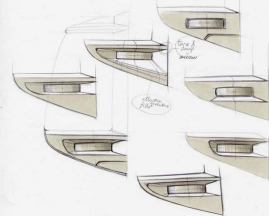
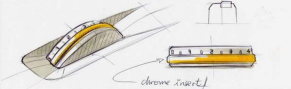
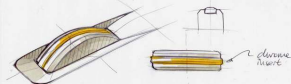
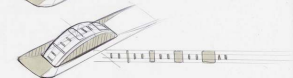
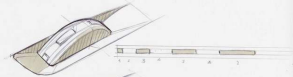
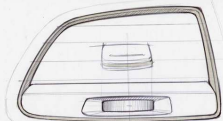

//0Y : AIRVENTS DETAILS





//RENAULT ESPACE





RENAULT TALISMAN 2017



RENAULT MEGANE 2017



RENAULT SCENIC 2017



RENAULT ESPACE 2016

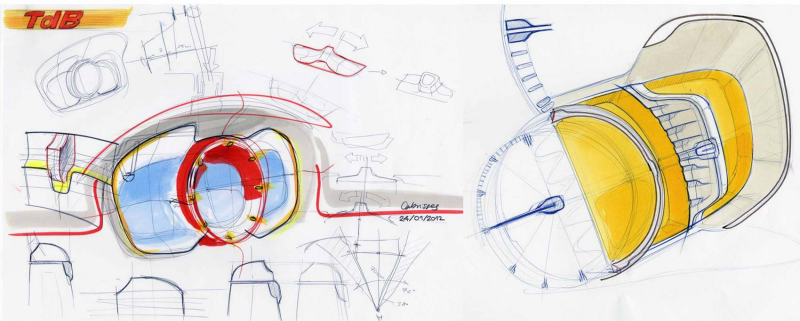

//COCKPIT : CLUSTER IDEAS





RENAULT TALISMAN 2017



RENAULT MEGANE 2017



RENAULT SCENIC 2017



RENAULT ESPACE 2016

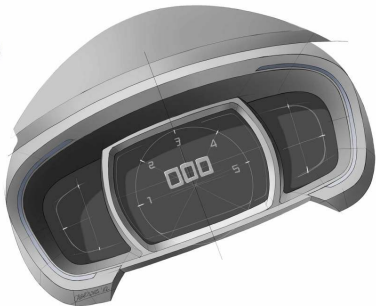
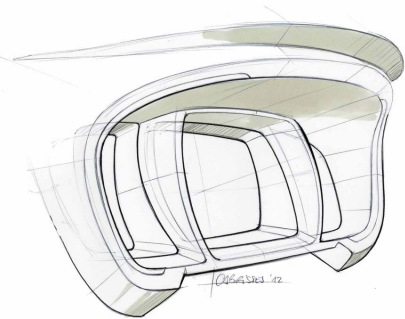

//COCKPIT : CLUSTER





RENAULT TALISMAN 2017



RENAULT MEGANE 2017



RENAULT SCENIC 2017



RENAULT ESPACE 2016

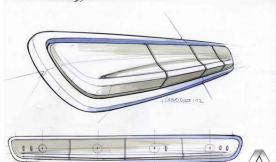
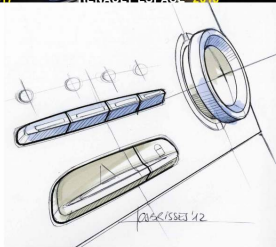

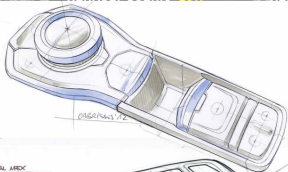
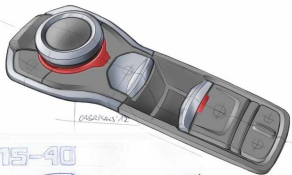

15-40

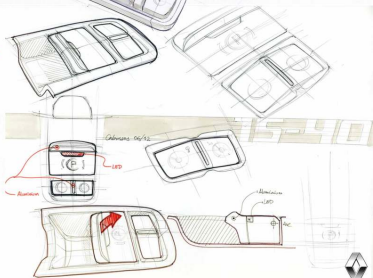
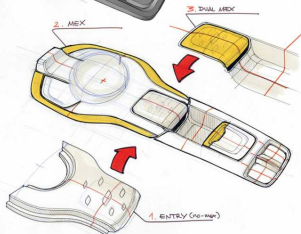

//OY : MMI





RENAULT TALISMAN 2017



RENAULT MEGANE 2017



RENAULT SCENIC 2017



RENAULT ESPACE 2016

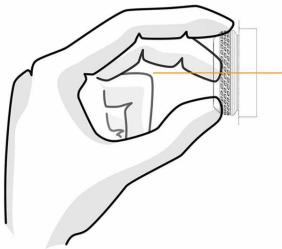

Lighting

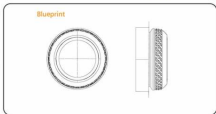

Blueprint



Texture-motive



Trim

Chrome

Matt Black

Specific trim

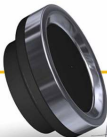

//0Y : ERGO KNOBS STUDY

00385517





RENAULT TALISMAN 2017



RENAULT MEGANE 2017



RENAULT SCENIC 2017



RENAULT ESPACE 2016

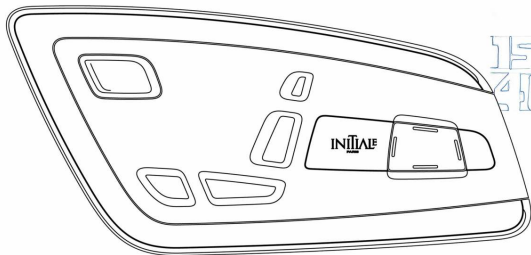

150
410

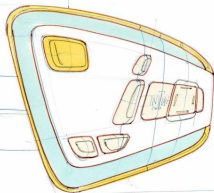

-  Chrome aspect.
-  Piano - black
-  Black smooth.

//SEAT : CONTROLS

Cabreras 11/05/2012



SEAT LEON 2013



//INTERIOR COMPONENTS



//CLUSTER & HVAC CONTROLS





//LAMBORGHINI AVENTADOR



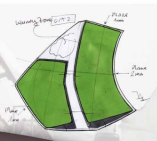

//CLUSTER



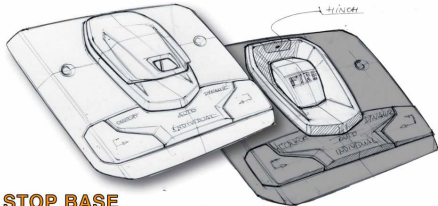
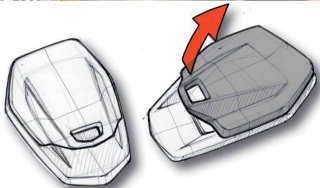

//START STOP BASE



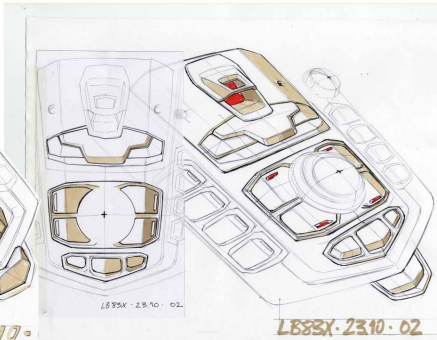
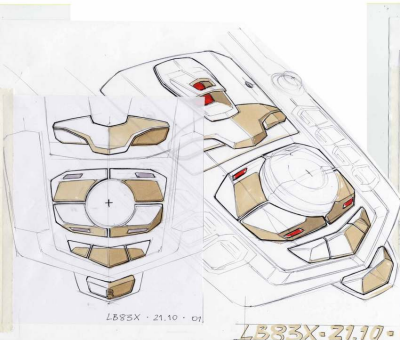



//0Y CENTER STACK





LAMBORGHINI AVENTADOR LP700-4 2012



///0Y CENTER STACK



//SEAT BOCANEGRA





//0Y : HVAC CONTROLS





SEAT TANGO 2004



SEAT ALTEA 2005



//DESIGN COLLABORATION





//SEAT SALSA



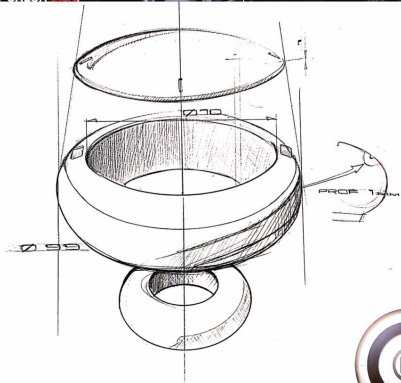

//COCKPIT : INSTRUMENTS METER

