



MINÖS DISEÑO

Carlos Gutiérrez Medrano

D.I



CALZADO







BOCETOS EN ILLUSTRATOR

bocetos otoño-invierno 2000











Yasuo

PiU ecoprimaver color
azuloscuro

lata

logo bordado fino de 4,00cm x 1,30cm
blanco/rojo/negro



PiU ecoprimaver color
gris

puerto en
rota gris/rojo



zona gris

zeta lateral exterior



Yasuo



Yasuo



HOJA DE PRODUCTO	
DESCRIPCION	TIPO
TIPO	TIPO
TIPO	TIPO
TIPO	TIPO
TIPO	TIPO

A	LETRA (IN CUTTING-PIECE) ON LANGUETS THE LETTERS ARE ON THE RIGHT (IN WHITE) LETRA (IN CUTTING-PIECE) IN THE YONG LETRA LATERAL (white color) (CUTTING-PIECE)	
B	THE LETTERS ARE ON THE RIGHT COUNTER LOGO (white color) (CUTTING-PIECE)	
C	PLAZA ATLETICA (MAY PLANTILLA) (CUTTING-PIECE) WORD ATLETICA IN SOLE LANGUETS ON LETTERS PRINTING TECHNIC	
D	LETRA ATLETICA (IN TACON BORDADO)	
E	LETRA ATLETICA (IN SOLE) (PRINTING)	
F	LETRA ATLETICA (IN SHOE) (PRINTING)	



See shoes & specifications and colors list. Accents printed in white
with application on ATLETICA (MAY) 5 104

HOJA DE PRODUCTO	
DESCRIPCION	TIPO
TIPO	TIPO
TIPO	TIPO
TIPO	TIPO
TIPO	TIPO

A	LETRA (IN CUTTING-PIECE) ON LANGUETS THE LETTERS ARE ON THE RIGHT (IN WHITE) COUNTER LOGO (CUTTING-PIECE)	
B	LETRA LATERAL (white color) (CUTTING-PIECE) THE LETTERS ARE ON THE RIGHT COUNTER LOGO (white color) (CUTTING-PIECE)	
C	PLAZA ATLETICA (MAY PLANTILLA) (CUTTING-PIECE) WORD ATLETICA IN SOLE LANGUETS ON LETTERS PRINTING TECHNIC	
D	LETRA ATLETICA (IN TACON BORDADO)	
E	LETRA ATLETICA (IN SOLE) (PRINTING)	
F	LETRA ATLETICA (IN SHOE) (PRINTING)	



See shoes & specifications and colors list. Accents printed in white
with application on ATLETICA (MAY) 5 104

HOJA DE PRODUCTO	
DESCRIPCION	TIPO
TIPO	TIPO
TIPO	TIPO
TIPO	TIPO
TIPO	TIPO

A	LETRA (IN CUTTING-PIECE) ON LANGUETS THE LETTERS ARE ON THE RIGHT (IN WHITE) COUNTER LOGO (CUTTING-PIECE)	
#1	IN BLACK COLOR	
#1	IN WHITE COLOR	
C	LETRA (IN CUTTING-PIECE) ON LANGUETS THE LETTERS ARE ON THE RIGHT (IN WHITE) COUNTER LOGO (CUTTING-PIECE)	
#2	IN BLACK COLOR	
#2	IN WHITE COLOR	



See shoes & specifications and colors list. Accents printed in white
with application on ATLETICA (MAY) 5 104

HOJA DE PRODUCTO	
DESCRIPCION	TIPO
TIPO	TIPO
TIPO	TIPO
TIPO	TIPO
TIPO	TIPO

A	LETRA (IN CUTTING-PIECE) ON LANGUETS THE LETTERS ARE ON THE RIGHT (IN WHITE) COUNTER LOGO (CUTTING-PIECE)	
B	LETRA LATERAL (white color) (CUTTING-PIECE) THE LETTERS ARE ON THE RIGHT COUNTER LOGO (white color) (CUTTING-PIECE)	
C	PLAZA ATLETICA (MAY PLANTILLA) (CUTTING-PIECE) WORD ATLETICA IN SOLE LANGUETS ON LETTERS PRINTING TECHNIC	
D	LETRA (IN CUTTING-PIECE) ON LANGUETS THE LETTERS ARE ON THE RIGHT (IN WHITE) COUNTER LOGO (CUTTING-PIECE)	
E	LETRA ATLETICA (IN TACON BORDADO)	
F	LETRA ATLETICA (IN SOLE) (PRINTING)	
G	LETRA ATLETICA (IN SHOE) (PRINTING)	



See shoes & specifications and colors list. Accents printed in white
with application on ATLETICA (MAY) 5 104





Los logos y logotipos así como los dibujos parciales y totales son propiedad de ATLETICA S.S. Y T.M.

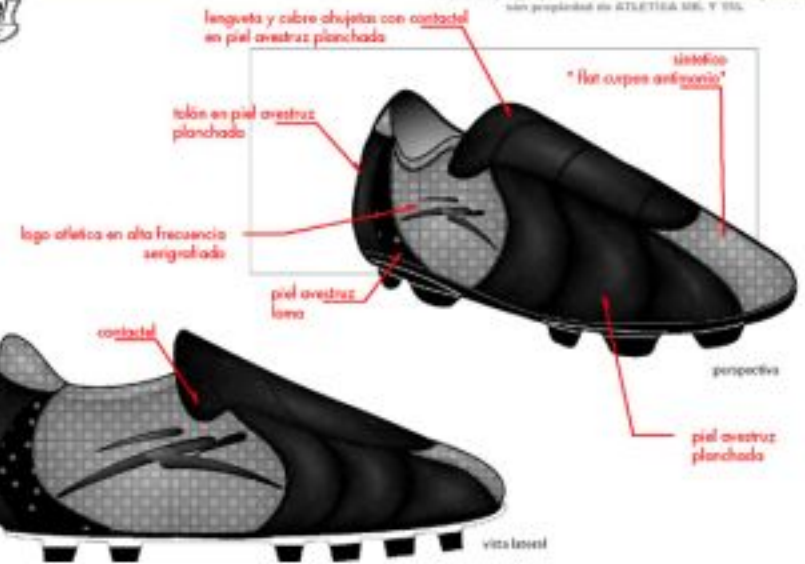

PROTOTIPO PARA DESARROLLAR "P-01"



verve guillemet m. D.L.



PROTOTIPO PARA DESARROLLAR "P-02"



Los logos y logotipos así como los dibujos parciales y totales son propiedad de ATLETICA S.S. Y T.M.

verve guillemet m. D.L.



FW 04

COLORIDO MUESTRAS

HOJA DE ESPECIFICACIONES

LINEA TENIS CASUAL FW 2004

00000000

CATEGORIA / CASUAL	NOMBRE /	VERANO 04
CODE / UPPER /	TEXTILE	VERANO 04 04
FOCRO / LINING /	MB 3d	
SUELA / OUTSOLE /	4x1, 2, 1, 1, 2, 2, 2, 2	
COLORIDA NUMEROS /	010 - 020	030 - 040

CANASTA 2.0

004-21-01



PANTONES



FW 04

COLORIDO MUESTRAS

HOJA DE ESPECIFICACIONES

LINEA TENIS CASUAL FW 2004

CATEGORIA / TENIS CASUAL	NOMBRE /	VERANO
CODE / UPPER /	TEXTILE	
FOCRO / LINING /	TEXTILE	
SUELA / OUTSOLE /	SATECA	
COLORIDA NUMEROS /	004-21-01, 02, 03, 04, 05, 06, 07, 08, 09	

00000 / CODE ARERICA - 00442801

CANASTA 2.0w

004-21-01



01 - 01

JUST LIKE THE SAMPLE

URBANO KY (A)

ATL color 277



JUST LIKE THE SAMPLE

URBANO KY (B)

ATL color 278

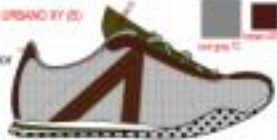

01 - 01

JUST LIKE THE SAMPLE

URBANO DAMA (A)

ATL color 001



000 / CODE ARERICA - 00442802

CHANGE THE YELLOW

URBANO DAMA (B)

ATL color 057



01 - 01

JUST LIKE THE SAMPLE

URBANO SUECO (A)

ATL color 050



WITH ELASTIC

JUST LIKE THE SAMPLE

URBANO SUECO (B)

ATL color 091



000 / CODE ARERICA - 00442803

WITH ELASTIC

by Carlos Gutierrez



HOJA DE ESPECIFICACIONES

LINEA FW 2004

00000 / CODE ATLICA 00000000

CATEGORIA PRODUCTO	NUMERO	ATL P-04
COTE / URPE	317421234	
FORO / UMBRO	10112	
RUEDA / OUTSOLE	K-5000	145
CANTONIA / NUMBER	27	21 21 cm
COMBINACIONES / COLOURS	00000000	00000000
000000	000000	000000
000000	000000	000000

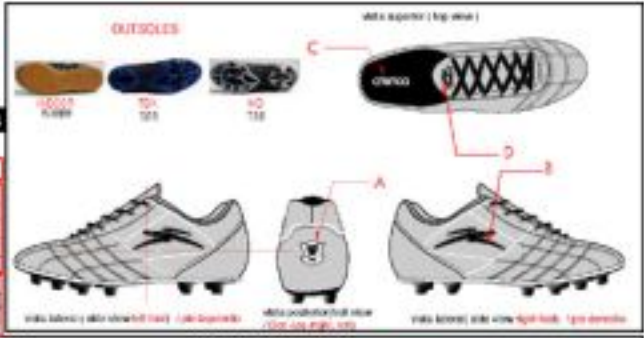

GRAFICOS Y TECNICAS / APPLICATIONS

A	ATL LOGO ATLETICA (FRECUENCIADO) (in the heel)	
	ATL LOGO ATLETICA (EMBOSADO) (in the heel)	
B	LOGO LATERAL ATLETICA (ALTA FRECUENCIA) EN AMBOS LADOS DEL ZAPATO COUNTER LOGO ATLETICA (EMBOSADO) IN BOTH SIDES OF THE SHOE	
C	PALABRA ATLETICA PARA PLANTILLA (SERIGRAFIA) (IN SCREEN PRINTING TECHNIC) (in)	
D	LOGO Y PALABRA ATLETICA (EN LENGUETA BORDADO) (ON THE TONGUE) LOGO ATLETICA (ON THE EMBROIDERY) (ON THE TONGUE)	

COLOR COMBINATIONS



HOJA DE ESPECIFICACIONES

LINEA FW 2004

00000 / CODE ATLICA 00000000

CATEGORIA PRODUCTO	NUMERO	ATL P-00
COTE / URPE	317421234	
FORO / UMBRO	10112	
RUEDA / OUTSOLE	K-5000	145
CANTONIA / NUMBER	27	21 21 cm
COMBINACIONES / COLOURS	00000000	00000000
000000	000000	000000
000000	000000	000000

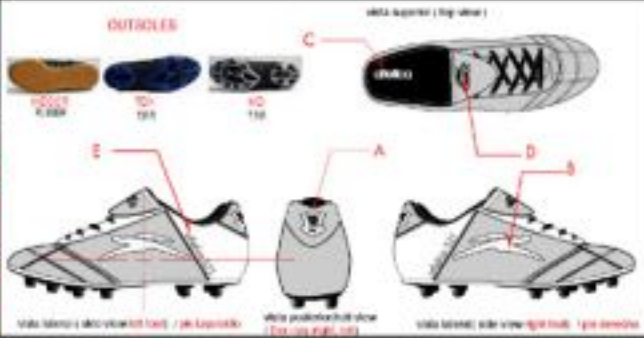

GRAFICOS Y TECNICAS / APPLICATIONS

A	ATL LOGO ATLETICA (FRECUENCIADO) (in the heel)	
	ATL LOGO ATLETICA (EMBOSADO) (in the heel)	
B	LOGO LATERAL ATLETICA (ALTA FRECUENCIA) EN AMBOS LADOS DEL ZAPATO COUNTER LOGO ATLETICA (EMBOSADO) IN BOTH SIDES OF THE SHOE	
C	PALABRA ATLETICA PARA PLANTILLA (SERIGRAFIA) (IN SCREEN PRINTING TECHNIC) (in)	
D	LOGO Y PALABRA ATLETICA (EN LENGUETA FRECUENCIADO) (ON THE TONGUE) LOGO ATLETICA (EMBOSADO) (ON THE TONGUE)	
E	LATERAL ATLETICA 521 (ALTA FRECUENCIA) (ON THE TONGUE) COUNTER LOGO ATLETICA 521 (EMBOSADO) (ON THE TONGUE)	

COLOR COMBINATIONS DETAILS



SANDALIAS

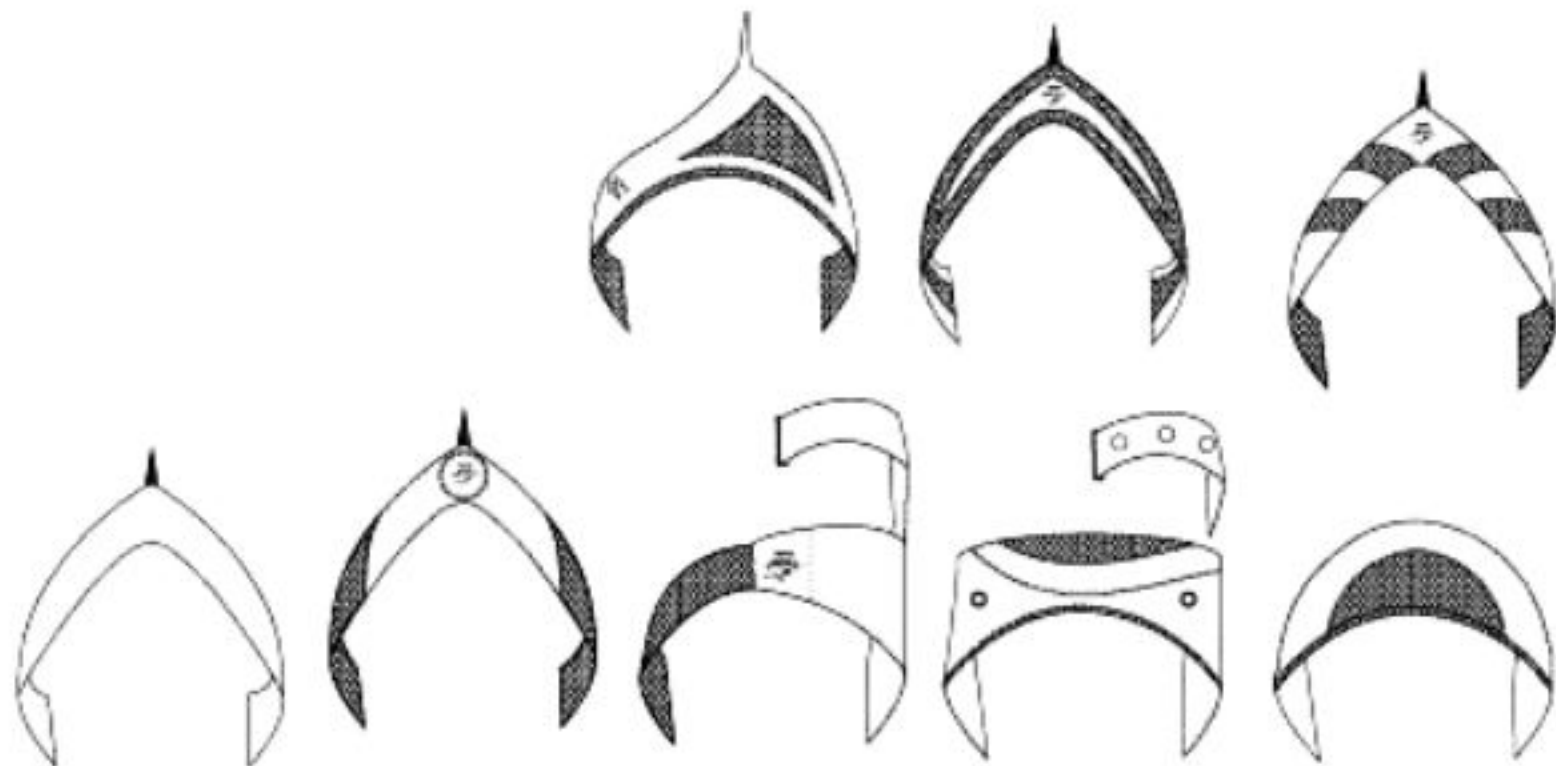









Sandals



Av. Juan Gil Preciado No. 5339
(Antes Carretera a Tesistán)
C.P. 45200 Zapopan, Jal.
E-mail: adriannares@hotmail.com
www.coollifesandals.com

Tels. (33) 3848-0550
3168-3814
3848-0551
Tel./Fax (33) 3834-5902



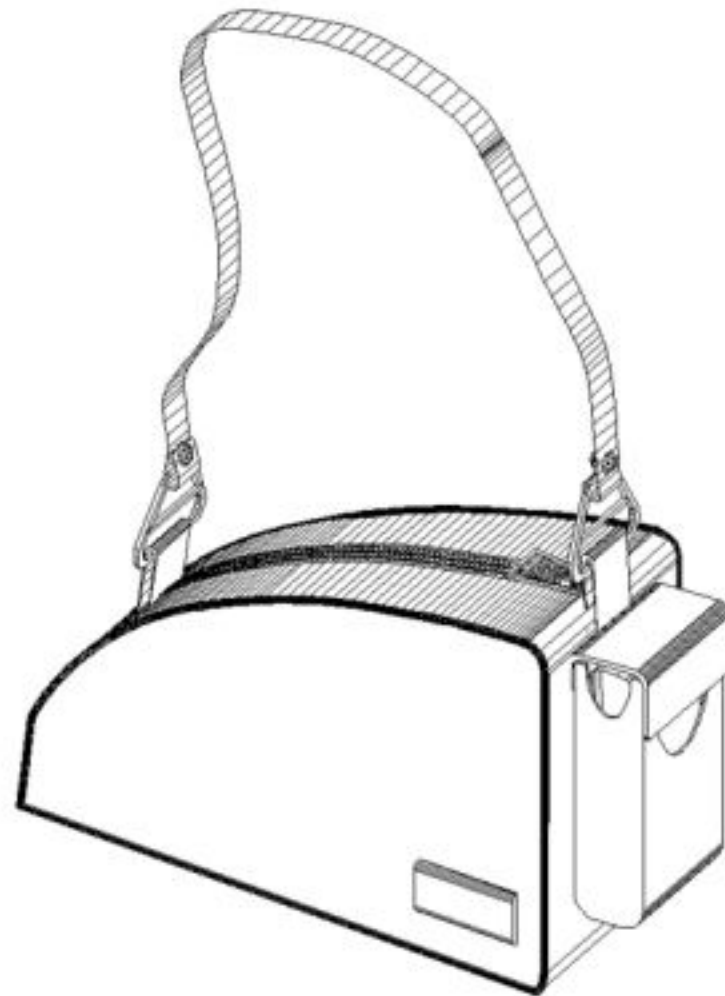

ACCESORIOS

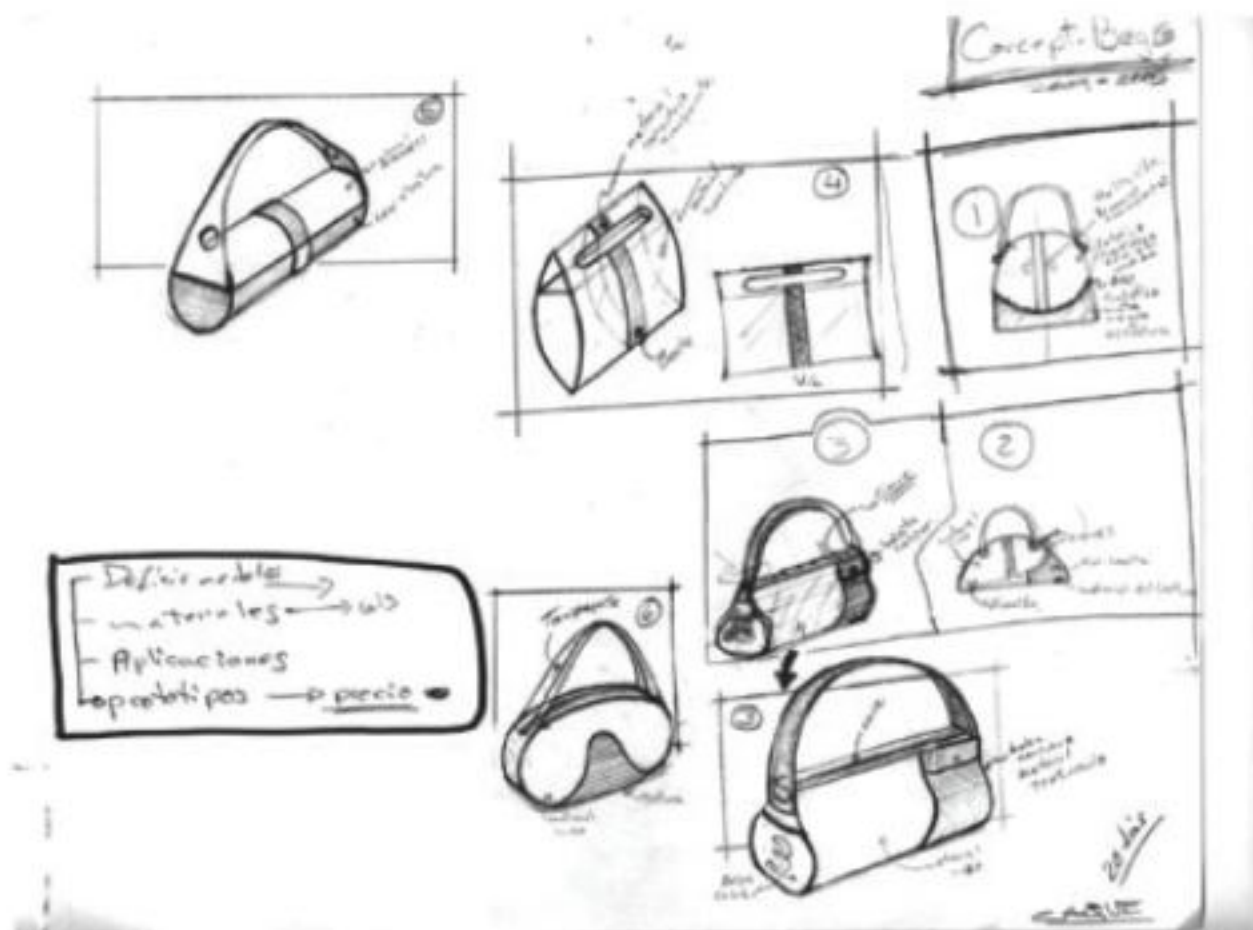

BOLSA DE MANO



By Carlos Galindo

BACKPACK



By Carlos Galindo

MALETA



By Carlos Salazar

NECESER



By Carlos Salazar

COSMETOLUBA



By Carlos Salazar



atletica woman 2004 **aw**

maleta accesorio domas

BOLSO DE MODA "AW TEEN"

CODIGO 30450606



NEGRO
COLOR ATLETICA
099

AZUL REBE
COLOR ATLETICA
098



AZUL MEZCLILLA
COLOR ATLETICA
M03



FILIZ DE ROSA
COLOR ATLETICA
017

Los colores y logotipos son marcas de propiedad intelectual y marcas
de propiedad de ATLETICA S.A. y T.S.R.

by Carlos Galvez M



atletica woman FW 2004 **aw**

maleta accesorio domas

BOLSO DE MODA "AW FIESTA"

CODIGO 00450604



AZUL REY
COLOR ATLETICA
047

CODIGO 00450604



NEGRO
COLOR ATLETICA
099

CODIGO 00450604



ROJO
COLOR ATLETICA
055

CODIGO 00450604



GRIS CLARO
COLOR ATLETICA
092

Los colores y logotipos son marcas de propiedad intelectual y marcas
de propiedad de ATLETICA S.A. y T.S.R.

by Carlos Galvez M



atletica woman 2004 **aw**

maleta accesorio domas

COMBINACIONES PARA BOLSO DE MANO "aw d'elca"

CODIGO 30450607

NEGRO
COLOR ATLETICA
099



BIANCO
COLOR ATLETICA
056



ROJO
COLOR ATLETICA
055



AZUL
COLOR ATLETICA
M03



Los colores y logotipos son marcas de propiedad intelectual y marcas
de propiedad de ATLETICA S.A. y T.S.R.

by Carlos Galvez M



GORRAS 2005



Left view



Front view

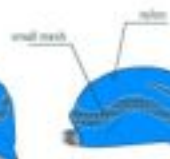

Right view



Perspective view

color 1
blue / olive

model " wave "



Back view



color 2
black - yellow



Right view

Perspective view

color 1
dark yellow - black



Left view



Front view

model " air "



Back view

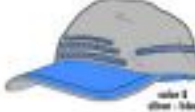

color 2
olive / blue

by Carlos Gutierrez III



modelo " A "



modelo " B "



by Carlos Gutierrez III



GRUPO ATLETICA BARRIO TIRORES 01

Modelos de Referencia construcción : 401-PUC-001 (PUMAS) **MODELO ATLETICA - TIRORES 01**

VISTAS GENERALES



COLORES ■ AMARILLO ■ AZUL

GRUPO ATLETICA BARRIO TIRORES 01

Modelos de Referencia construcción : 401-PUC-001 (PUMAS) **MODELO ATLETICA - TIRORES 01**
 (Modelos de Referencia construcción) (colores en negro) : 001 116473 (PUMAS)

VISTAS GENERALES



COLORES ■ AMARILLO ■ AZUL

GRUPO ATLETICA BARRIO TIRORES 01

Modelos de Referencia : 401-AMC-W04 (Jaguars) **Jaguars-04 (Jaguars)**

■ AZUL
■ AMARILLO
■ NEGRO



GRUPO ATLETICA BARRIO TIRORES 01

MODELO TIRORE ATL 01

VISTAS GENERALES



COLORES ■ AMARILLO ■ AZUL

GRUPO ATLETICA BARRIO TIRORES 01

MODELO TIRORE ATL 02

VISTAS GENERALES



COLORES ■ AMARILLO ■ AZUL

GRUPO ATLETICA BARRIO TIRORES 01

Modelos de Referencia construcción : 402-AMC-W07 (Jaguars) **MODELO ATLETICA - TIRORES 02**
 BNF 116473 (Jaguars)

VISTAS GENERALES



COLORES ■ AMARILLO ■ AZUL





PRODUCTOS CON APLICACION * O.S *

las ideas y logotipos así como los diseños parciales y totales son propiedad de ATLETICA MR. Y TM.



palma de latex

O.S

fuelle : NEUROPOL MED.

ENERO 2003

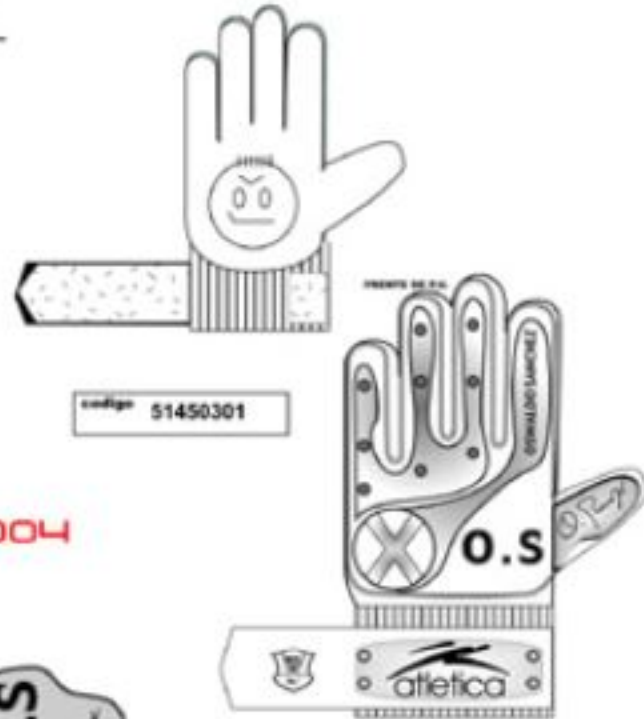

codigo 51450301

AGOSTO 2004
tentativo



O.S

fuelle : gadget



Modelo "STAR" accesorios FW 2004
GENÉRICO Y EQUIPOS

Para fabricar y registrarlos en el nombre de Atlético Madrid, sus licencias y sus derechos de propiedad intelectual, se han presentado los modelos de los colores, y sus

ATL color
087

43450602



ATL color
095

42450602



ATL color
088

33450602



ATL color
090

71450602



87450604

ATL color
090



34450602

ATL color
014



73450602

ATL color
000



00450602

ATL color
000



Hoja de Especificaciones
CANGURERA "SKIFY" EQUIPOS FW 2004

TALLAS ÚNICA COLORES MATERIAL: canasta



87450605

ATL color
110

- 021c
- 138c
- black
- 349c
- 185c

5 cm



43450603

ATL color
057

- 296c
- withe

4 cm

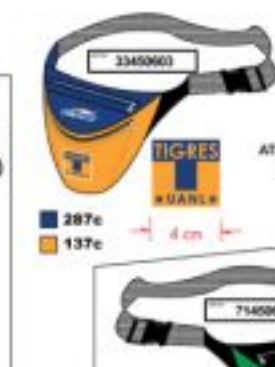

33450603

ATL color
013

- 287c
- 137c

4 cm



71450603

ATL color
043

- 356c
- black
- 137c

4 cm



42450603

ATL color
035

- 185c
- withe
- 456c
- black

4 cm

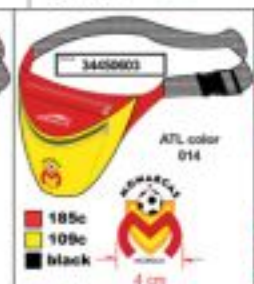

34450603

ATL color
014

- 185c
- 109c
- black

4 cm



73450603

ATL color
000

- 123c
- 185c
- withe

4 cm

By Carlos Gutiérrez M.



ESPECT Portafolio "DIRECT" y equipos / atletica / summer 2005

GRABADOS Y TÉCNICAS / APLICACIONES

22/02/2005

atletica

PLACETA blanca EN PLASTICO
código



LEUDO blanca EN SERGRAFIA
DOBLE PASADA



LEUDO blanca EN PLASTICO
ANILAS DE LOS PROVEEDORES



ENCUADRE EQUIPOS
NO MAYOR A 3.3 CM
DE BASE
PLASTICO + TIRAS + BORDADO



EQUIPOS

PLACETAS



NO SE ENTREGA
AL FINALIZAR EL
PROYECTO

By Carlos Gutiérrez M. 22 February 2005
Proyecto / atletica 2004 2005

DESARROLLO DE PRODUCTOS



TIGRES 2003
PROPUESTA



JERSEY LOCAL



JERSEY VENTA



JERSEY TERCERO



MINOS
carlos gutierrez

AREA TEXTILES



La momento de el regreso del uniforme todo en amarillo y el negro, que utilizarán en ocasiones especiales. Foto:

ASTEX

El Astex es un producto que protege y preserva el color de la ropa deportiva durante su uso y lavados. Es un producto que se aplica directamente sobre la ropa deportiva antes de lavarla. El Astex es un producto que se aplica directamente sobre la ropa deportiva antes de lavarla. El Astex es un producto que se aplica directamente sobre la ropa deportiva antes de lavarla.



Calles y Galvan

ASTEX

El Astex es un producto que protege y preserva el color de la ropa deportiva durante su uso y lavados. Es un producto que se aplica directamente sobre la ropa deportiva antes de lavarla. El Astex es un producto que se aplica directamente sobre la ropa deportiva antes de lavarla. El Astex es un producto que se aplica directamente sobre la ropa deportiva antes de lavarla.



Calles y Galvan

ASTEX

El Astex es un producto que protege y preserva el color de la ropa deportiva durante su uso y lavados. Es un producto que se aplica directamente sobre la ropa deportiva antes de lavarla. El Astex es un producto que se aplica directamente sobre la ropa deportiva antes de lavarla. El Astex es un producto que se aplica directamente sobre la ropa deportiva antes de lavarla.



Calles y Galvan

UNIFORME DEPORTIVO LAGUNA 2002-2003

The advertisement displays a collection of sports uniforms for Laguna 2002-2003. It includes several kits: a green and white striped kit with 'SORIANA' and '58' branding; a white kit with 'SORIANA' and '58' branding; a green and black striped kit with 'SORIANA' branding; and a black kit with 'SORIANA' and '58' branding. The uniforms are accompanied by shorts, socks, and a jersey with the number '29'. The background features a soccer field and a player in action.



LIGA NACIONAL DE BASKETBOL



SEVILLA LOCAL



ESPANIA



ESPANIA



SEVILLA LOCAL



LIGA NACIONAL DE BASKETBOL



SEVILLA LOCAL



ESPANIA



ESPANIA



SEVILLA LOCAL



LIGA NACIONAL DE BASKETBOL



SEVILLA LOCAL



ESPANIA



ESPANIA



SEVILLA LOCAL



LIGA NACIONAL DE BASKETBOL



SEVILLA LOCAL



ESPANIA



ESPANIA



SEVILLA LOCAL



ESTEX

Este set de echipament este conceput pentru a oferi un nivel ridicat de performanță și confort. Este realizat dintr-un material special, care permite o bună aerisire și transpirație, asigurând astfel o răcoare și o protecție împotriva razei UV. Este disponibil în două variante de culoare: galben-roșu și maro-roșu.



Este un set de echipament conceput pentru a oferi un nivel ridicat de performanță și confort. Este realizat dintr-un material special, care permite o bună aerisire și transpirație, asigurând astfel o răcoare și o protecție împotriva razei UV. Este disponibil în două variante de culoare: galben-roșu și maro-roșu.



Este un set de echipament conceput pentru a oferi un nivel ridicat de performanță și confort. Este realizat dintr-un material special, care permite o bună aerisire și transpirație, asigurând astfel o răcoare și o protecție împotriva razei UV. Este disponibil în două variante de culoare: galben-roșu și maro-roșu.



BASTI LUCIU



BASTI VOICA



BASTI VOICA

Carlos Gutierrez

ESTEX

Este set de echipament este conceput pentru a oferi un nivel ridicat de performanță și confort. Este realizat dintr-un material special, care permite o bună aerisire și transpirație, asigurând astfel o răcoare și o protecție împotriva razei UV. Este disponibil în două variante de culoare: alb-bleu și alb-roșu.



Este un set de echipament conceput pentru a oferi un nivel ridicat de performanță și confort. Este realizat dintr-un material special, care permite o bună aerisire și transpirație, asigurând astfel o răcoare și o protecție împotriva razei UV. Este disponibil în două variante de culoare: alb-bleu și alb-roșu.



Este un set de echipament conceput pentru a oferi un nivel ridicat de performanță și confort. Este realizat dintr-un material special, care permite o bună aerisire și transpirație, asigurând astfel o răcoare și o protecție împotriva razei UV. Este disponibil în două variante de culoare: alb-bleu și alb-roșu.



BASTI LUCIU



BASTI VOICA



BASTI VOICA

Carlos Gutierrez



DESIGNS PANA COMSPORT U.S.A. DEC. 2002 / PANA CHICAGO 2004





atletica futbol 2004

guantes genericos futbol 2004

niño



carlos gutierrez m. D.



atletica futbol 2004

guantes genericos futbol 2004

fuego



carlos gutierrez m. D.

ACCESORIOS O.S. extream *O.P. Pujol*

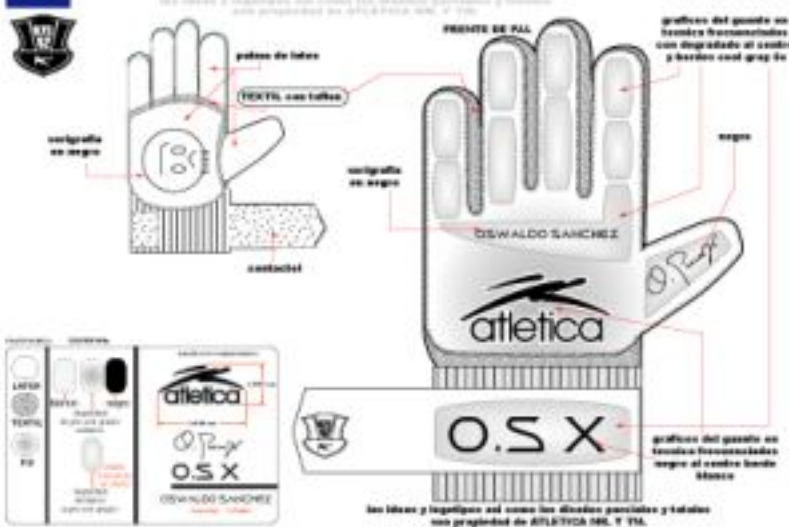

atletica futbol 2004

guantes genericos futbol 2004



carlos gutierrez m. D.



SKINGLOVE 2002

**FRENTE DE P.U.
FRECUENCIADO**



**palma de latex
parte inferior de la mano**



parte superior de P.V.C.

upper view

**FRENTE DE P.U.
FRECUENCIADO**

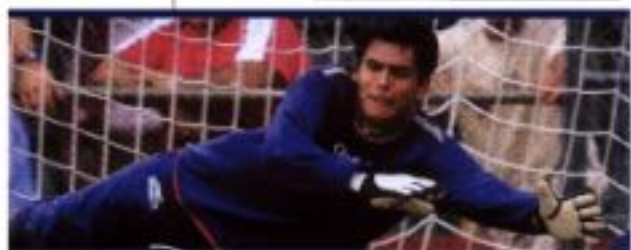

© SKINGLOVES



BALON PROFECIONAL FIFA APPROVED - 2005
TEUTON

MATERIAL REFERENCE
 T/CUS LINE 5005/02
 PREMIER color White
 TRAINING LINE 510001
 SPIKE SILVER
 MATCH LINE 5004
 LUMINA SILVER

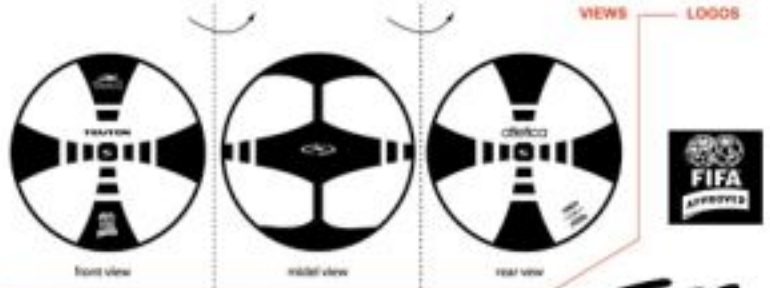
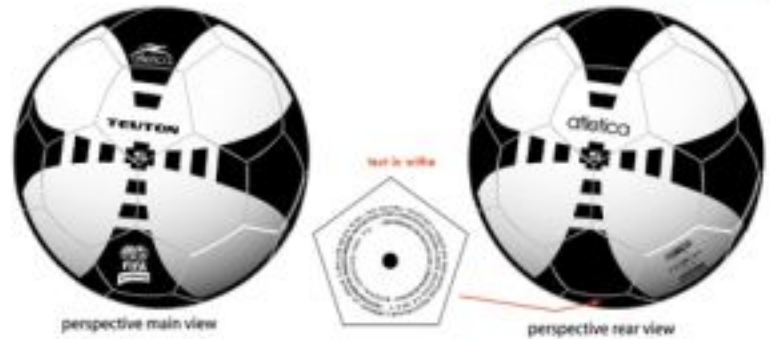

PROPUESTAS BALON - 2004
SAMPLE ESPECTS ALIEN SILVER

P.U. 5005/01
 SPIKE / SILVER
 MATERIAL
 (TRAINING LINE)
 KAP SUPLIER



ALIEN
 FONT : IMPUDOPF MEDIUM
 ALL WEATHER RESISTANT
 OFICIAL SIZE AND WHET
 TODO TERRENO Y CLIMA
 PESO Y MEDIDAS OFICIALES
 FONT : COPPERLATE GOTHIC REGULAR



los logos y tipografias son como los diseños parciales y totales
 son propiedad de ATLETICA RL Y TM.

mac fonts

PROPUESTAS BALON - 2004 ESPECTS
SAMPLE ESPECTS TORNEO



combinations teams

021c
 black
 gradient

cool gray 6c

BALL P.U. 5005/01 PREMIER / SILVER MATERIAL (CLUB LINE) KAP SUPLIER

los logos y tipografias son como los diseños parciales y totales
 son propiedad de ATLETICA RL Y TM.



ESPECTOS mini BALON ATLETICA – 2005

mini balón "PREMIER" ATL2005

00550101 000

MATERIAL REFERENCE:
CLUB LINE 2005/02
PREMIER color White, No. 0 ball

4/03/05



PANTONES

- BLUE 281 C
- RED 185 C

GRAPHICS

2.0 cm



by carlos Gutiérrez M



ESPECTOS mini BALON EQUIPOS – 2005

mini balón "premier" EQ 2005

MATERIAL REFERENCE:
CLUB LINE 2005/02
PREMIER color White, No. 0 ball

4/03/05



Monterrey

- AZUL 282 C
- ORANGE 021 C

TIGRES

- AMARILLO 137 C
- AZUL 287 C

Necaxa

- ROJO 185 C
- AMARILLO 137 C

Tecos

- ROJO 185 C
- YELLOW 137 C

Toluca

- ROJO 185 C
- PROCESS BLACK C
- DORADO 456 C

Moreros

- INVERNO PROCESS BLACK
- NEGRO PANTONE 200
- AMARILLO PANTONE 100

Puebla

- AZUL 300 C
- BLUE 281 C

Jaguars

- YELLOW GRAPHIC PANTONE 100 C
- NEGRO GRAPHIC PANTONE 200 C
- NEGRO GRAPHIC PANTONE 100 C
- ORANGE 021 C

Santos

- VERDE 396 C
- AMARILLO 137 C

NAMES AND PANTONES



by carlos Gutiérrez M



PROPUESTAS BALON – 2005

SAMPLE ESPECTS BASKETBALL

6 Diciembre 2004



atletica
BASKETBALL
FONT: ALIEN LEAGUE

ALL WEATER RESISTANT
OFFICAL SIZE AND WEIGHT
TODO TERRENO Y CLIMA
PESO Y MEDIDAS OFICIALES

mac fonts

Please read the rest of the competition
around the value hole (composition of the ball, materials and process, etc.)

Las ideas y logotipos así como los dibujos parciales y totales
son propiedad de ATLETICA MS. Y TU.

Mac fonts
The fonts included in this document
are property of atletica 2004 2005



PROPUESTAS BALON – 2005

SAMPLE ESPECTS VOLLEYBALL

SANDBLAST

6 Diciembre 2004

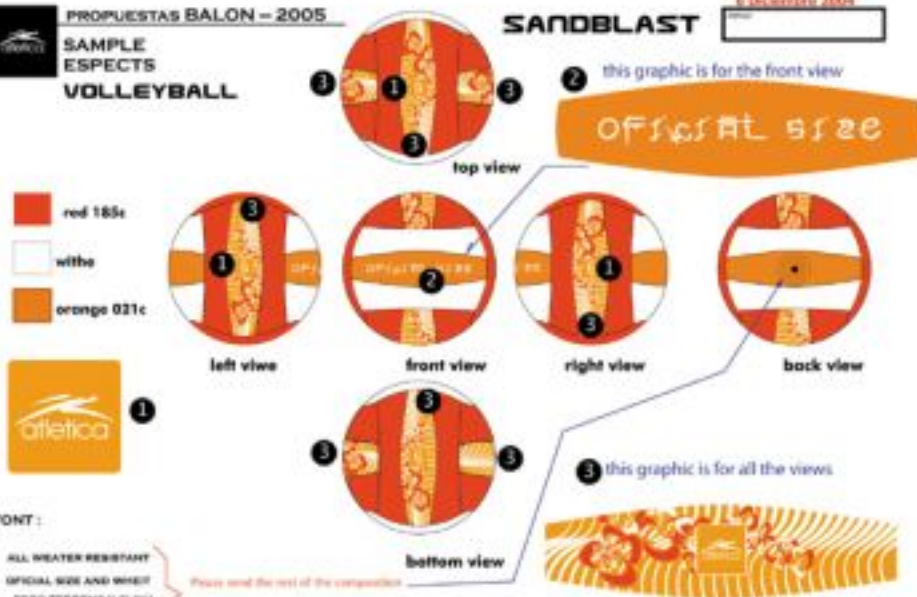

FONT:

ALL WEATER RESISTANT
OFFICAL SIZE AND WEIGHT
TODO TERRENO Y CLIMA
PESO Y MEDIDAS OFICIALES

mac fonts

Please read the rest of the competition
around the value hole (composition of the ball, materials and process, etc.)

Las ideas y logotipos así como los dibujos parciales y totales
son propiedad de ATLETICA MS. Y TU.

Mac fonts
The fonts included in this document
are property of atletica 2004 2005

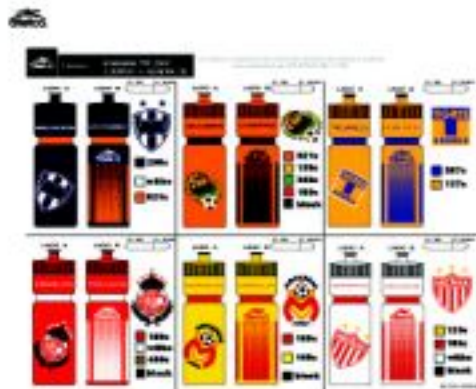

PORTAFUJES



By Carlos Gutierrez



Meja de Especificaciones
 ESPINILLERA "SHIELD" GENERICA FW 2004

00711B01

TALLAS: UNICA
 COLORES
 MATERIAL: PVC MOLDEADO



AMARELLO pantone 7408 C



ROJO pantone 188 C



AZUL pantone 654 C

By Carlos Gutierrez M

PORTAFUJES

Logo de un jugador de fútbol con el nombre del jugador y el número de la camiseta.

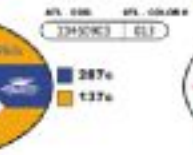
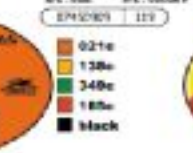

By Carlos Gutierrez

moleta triangular chiapas 03 / atletica / summer 2005

Product Reference / Referencia



MULTI TANGUAS II

MOCHILA MARINO 057
ATL C LAZARZA



Atletica
CHIAPAS
Sistema de Chiapas
Uno con Todos

moleta ultra chiapas 03 / atletica / summer 2005

Product Reference / Referencia



MULTI LITRO

LAZO ANILAS

LAZO ESTADISTICO



Atletica
CHIAPAS
Sistema de Chiapas
Uno con Todos

Atletica Asociacion PA 20M GENCO Y EQUIPOS

Se debe registrar cada uno de los diseños comerciales y marcas con protección de DISEÑO REG. Y PAT.



By Carlos Gutiérrez

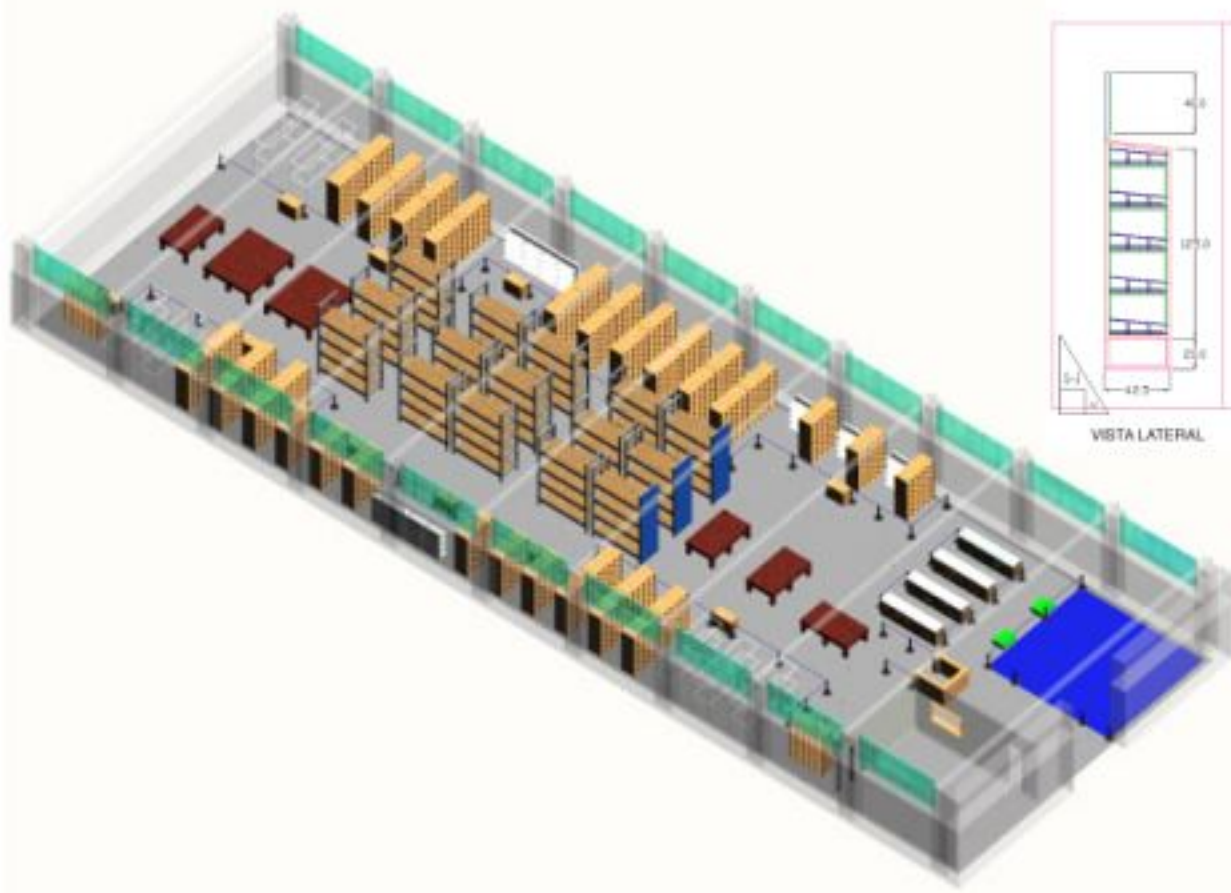

PLANOS GENERALES

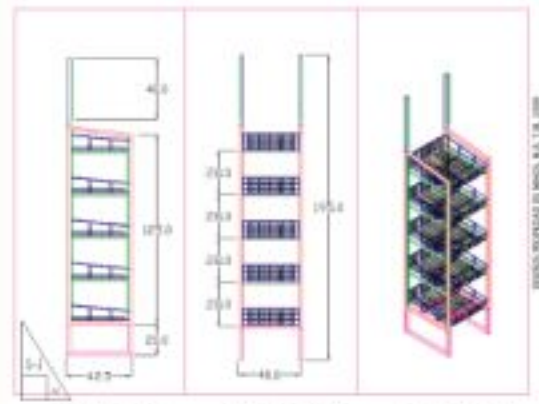

VISTA LATERAL

VISTA FRONTAL

PERSPECTIVA

SIN ESC.

SERVICIO UNIVERSITARIO DE MAQUINARIA S.A. DE C.V.



PLANOS GENERALES

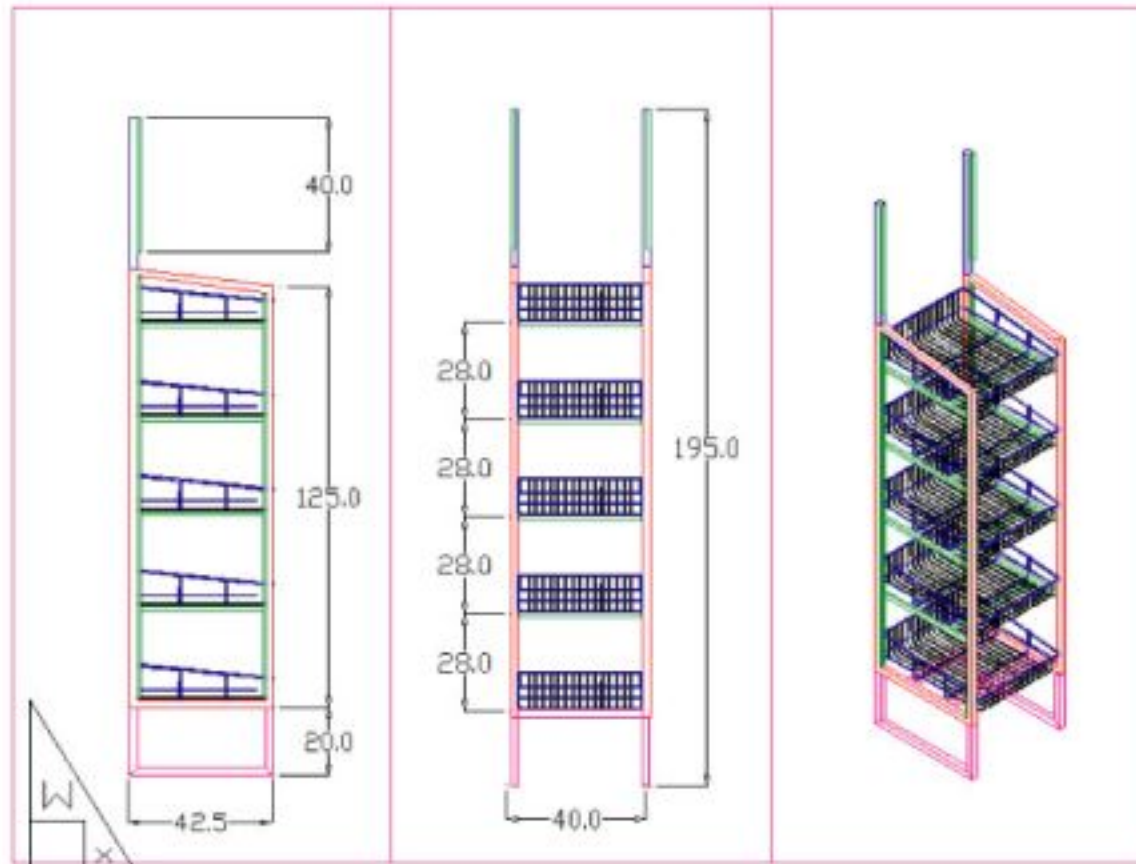

VISTA LATERAL

VISTA FRONTAL

PERSPECTIVA

SIN : ESC.

DISEÑOS PROPIEDAD DE MINOS. M.R. T.M. 1999



EXHIBI-2 



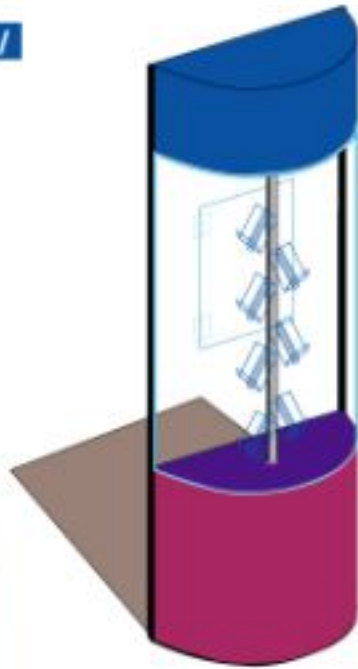





DINERO POR PAGO DE MÓVIL. N.º. 1.00. 1998



CON VINIL



CON GRÁFICO

BUZÓN DE SUGERENCIAS TIPO B-1

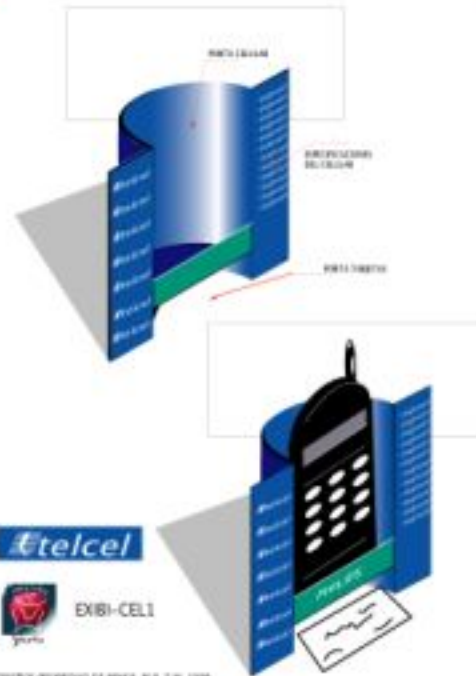

DINERO POR PAGO DE MÓVIL. N.º. 1.00. 1998



PERSPECTIVAS
EXHIBI - VARIANTE



DISEÑO PROPIEDAD DE MINDS, M.E.T.M. 1998

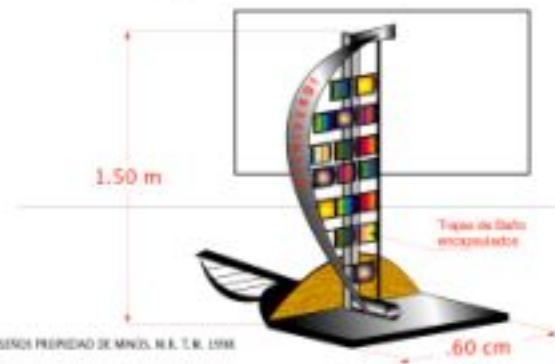

DISEÑO PROPIEDAD DE MINDS, M.E.T.M. 1998

* Exhibidor para botellas de aceite Mexlub
* En alambre, lámina y soldadura de microalambre

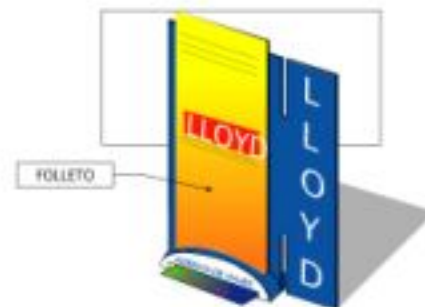
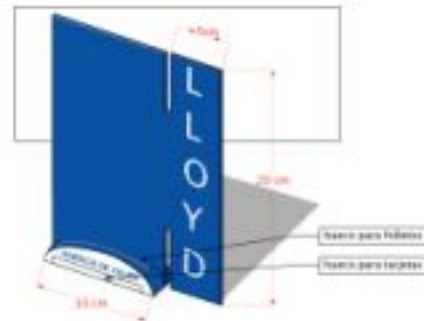

DISEÑO PROPIEDAD DE MINDS, M.E.T.M. 1998

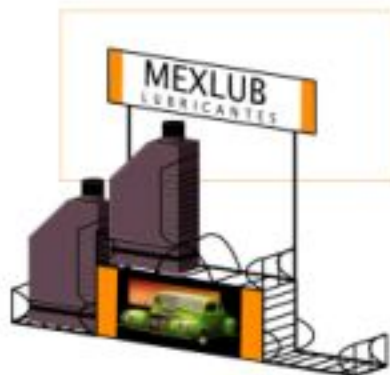

DISEÑO PROPIEDAD DE MINDS, M.E.T.M. 1998

PUESTO DE SOUVENIRS TOTALMENTE PORTATIL



MODELO

modulo atletico

CATEGORIA: PUNTO DE VENTA,
ISOMETRICO 45° / EXPLOTADO DE LONAS

- ESTRUCTURA EN ALUMINIO
- FORROS EN LONA / SE COLOCAN CON SILENCIO DE CONTACTO
- LONAS CON GRAFICOS

WEAR YOUR HEART

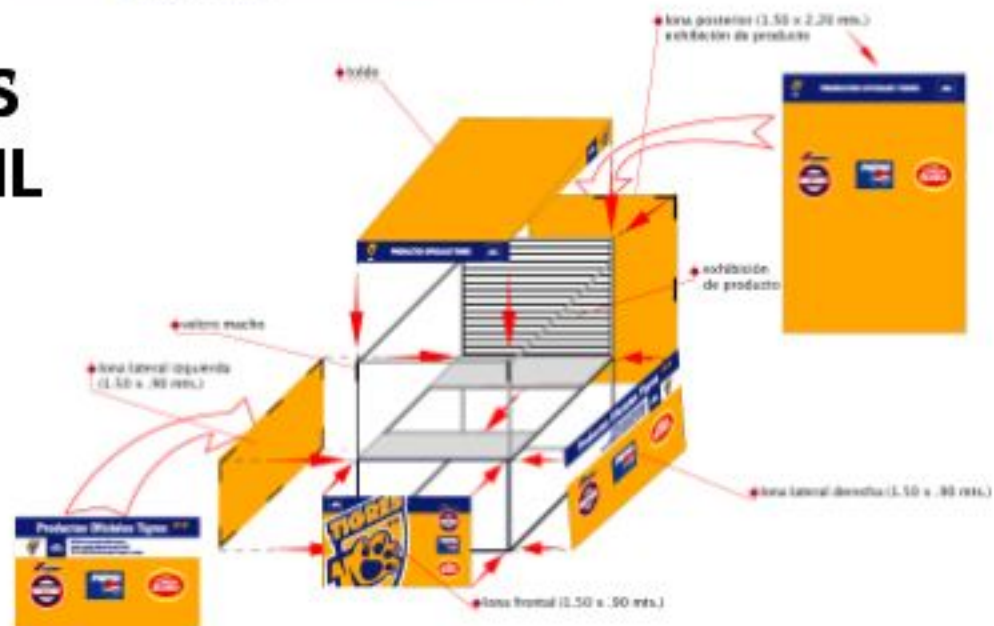

MODELO

modulo atletico EIP

CATEGORIA: PUNTO DE VENTA,

ISOMETRICO GENERAL

ESTRUCTURA EN ALUMINIO

FORROS EN LONA

SE COLOCAN EN SILENCIO DE CONTACTO

WEAR YOUR HEART



lona lateral izquierda



lona trasera



lona lateral derecha

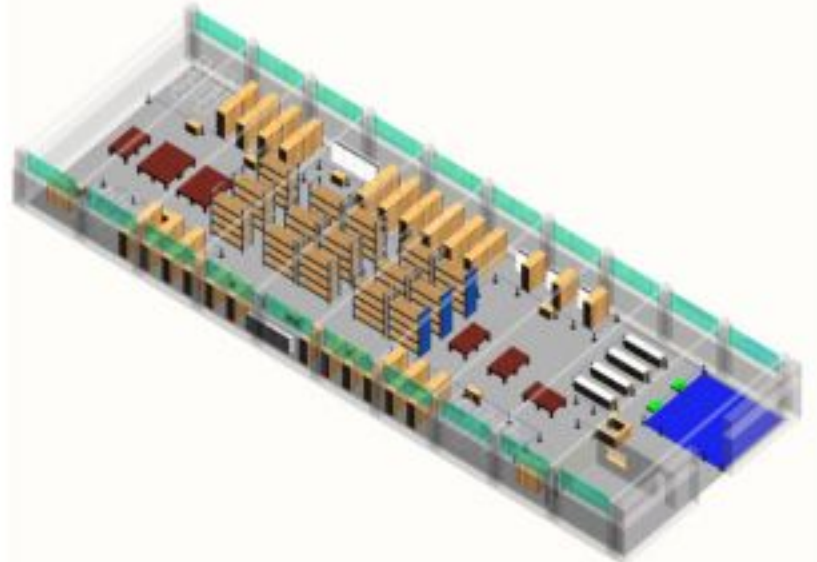
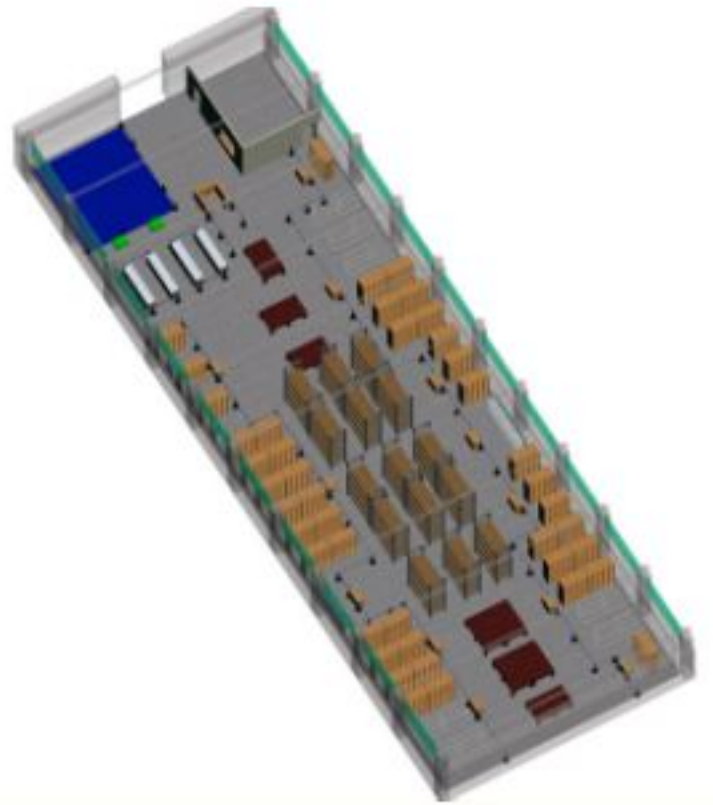
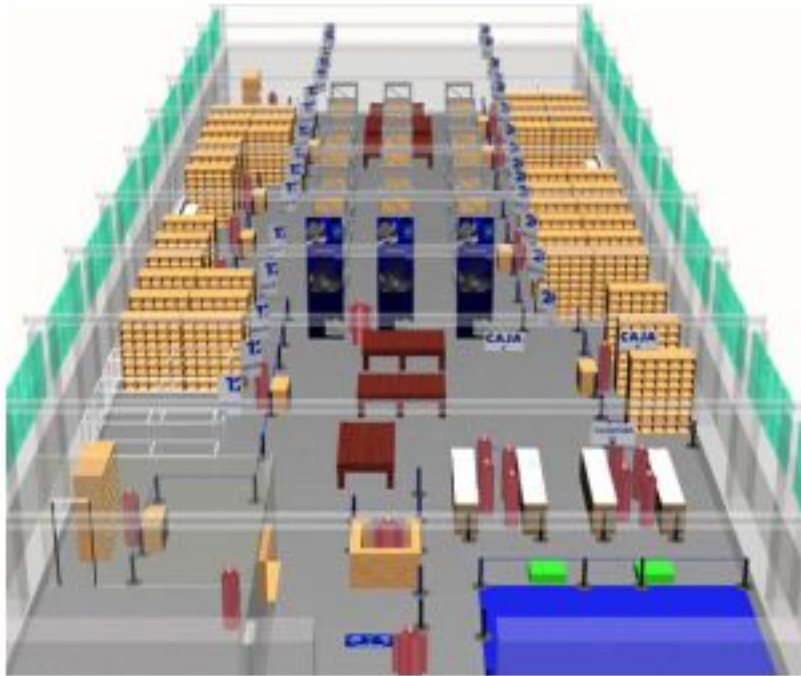





MODELO:
TRAILER "ATLETICA"

CATEGORIA: TIENDA MOVIL
vistas principales exteriores con accesorios.
sin escala



VISTAS LATERALES



VISTA POSTERIOR



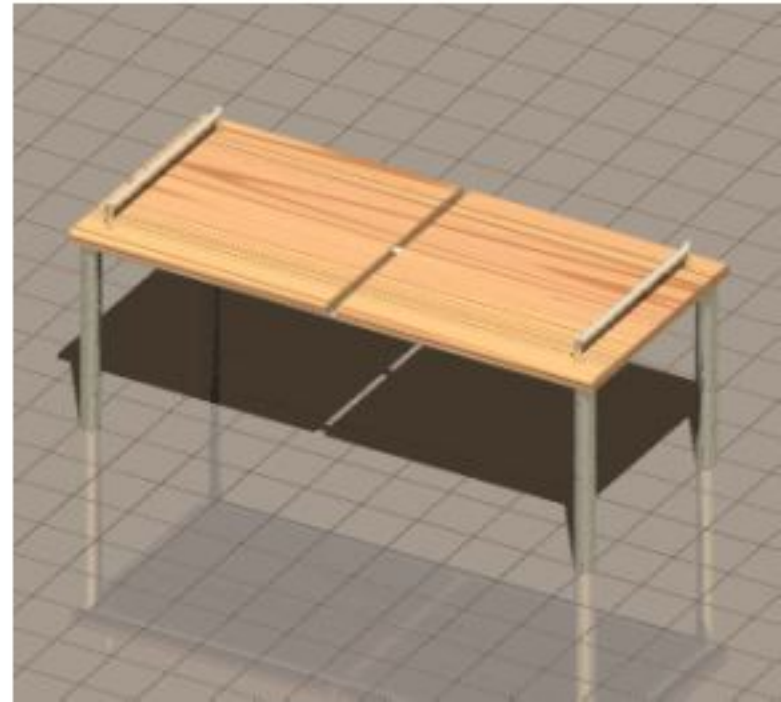
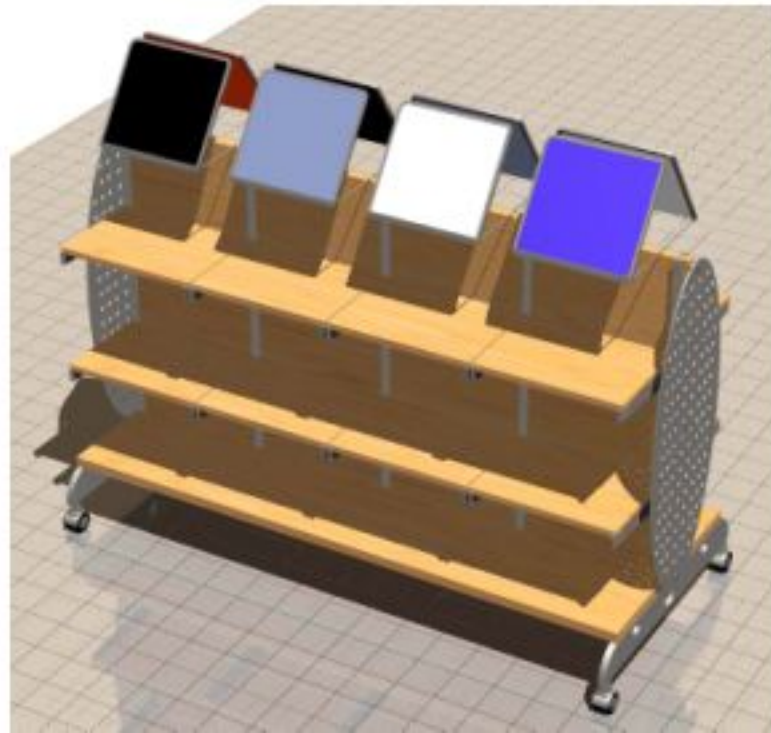
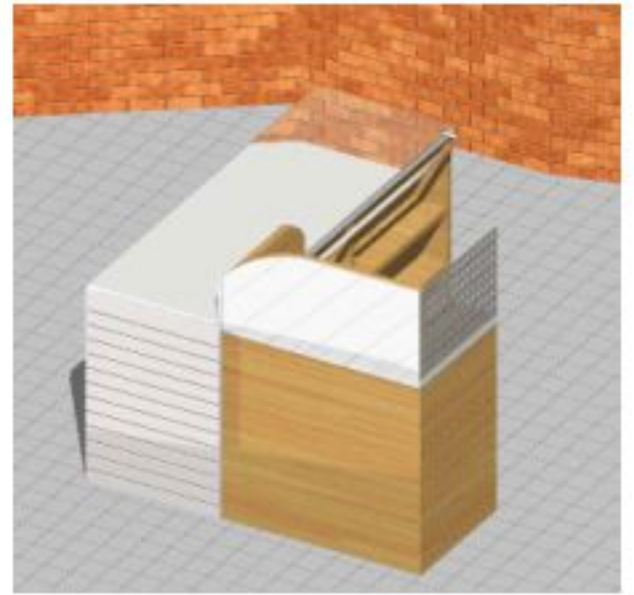
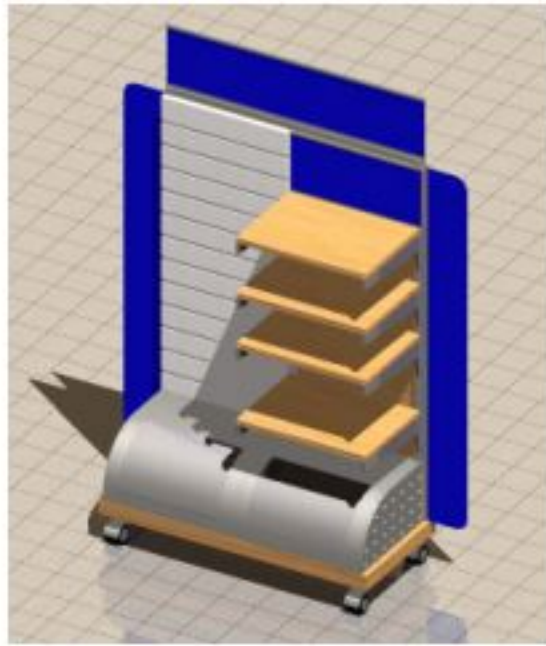



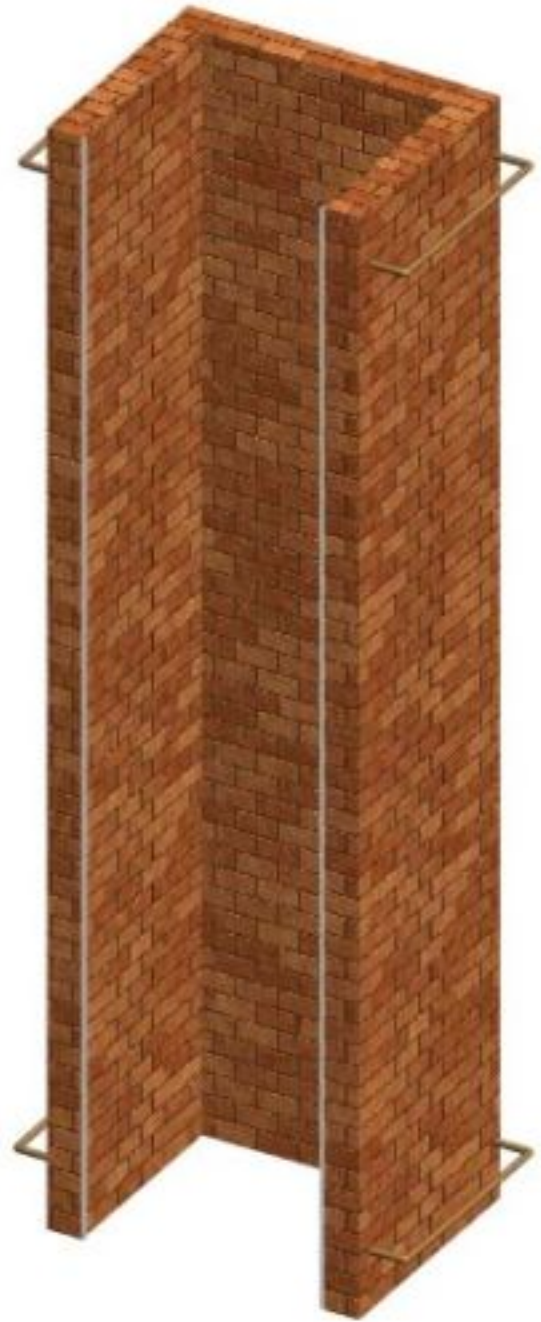
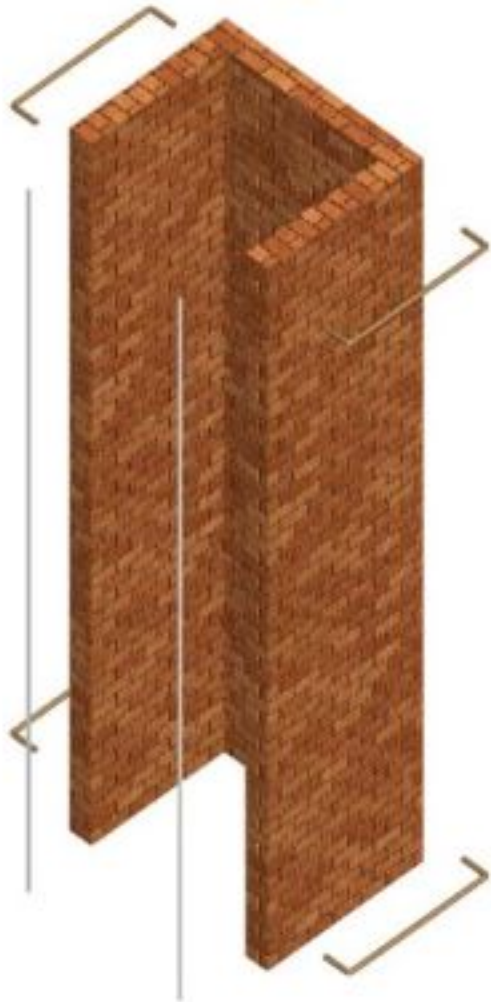

PORTA POSTERS (PARA MURO)





Estudio mueble Calzado 2003

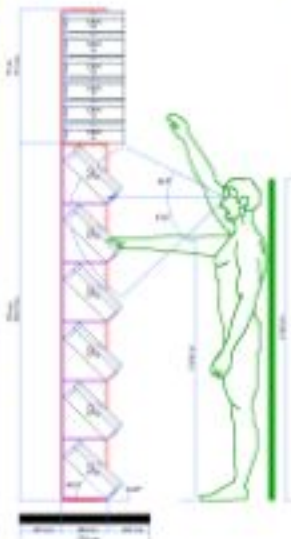
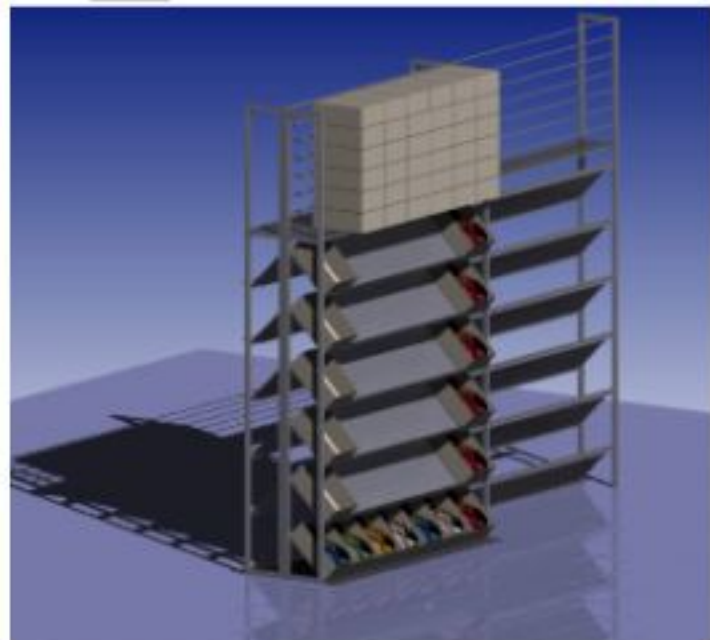

Estudio mueble Calzado 2003

BASE LINEAL DE EXHIBICION **SHOES** (LINA **VAL**) = 3,20 m.
MODELOS DE BATERIA DE CALZADO MODELOS DE 1,40 x 2,60 = 94 pares
MODELOS DE BATERIA (parte superior) MODELOS DE 1,40 x 2,60 = 94 pares

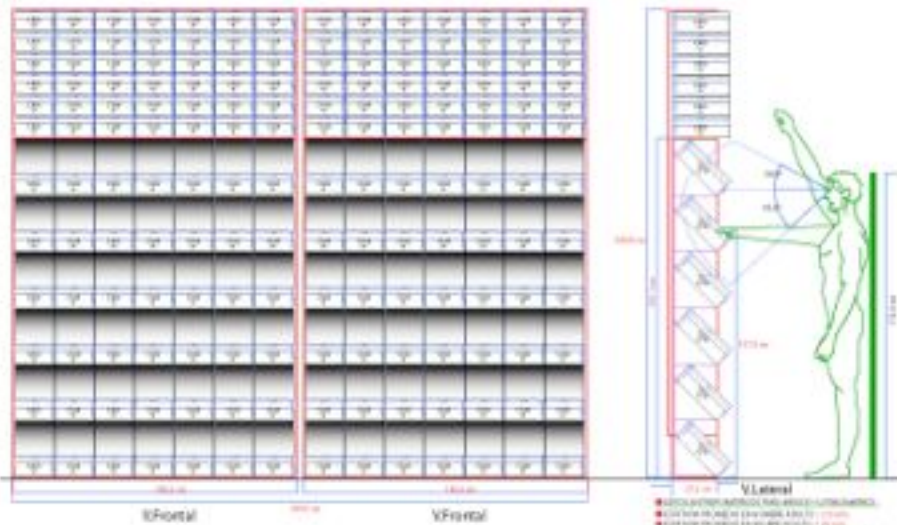

- ANCHO DE LA LINEA DE EXHIBICION = 1,40 m.
- ALTURA DE LA LINEA DE EXHIBICION = 2,60 m.
- ANCHO DE LA BATERIA DE CALZADO = 1,40 m.
- ALTURA DE LA BATERIA DE CALZADO = 2,60 m.
- ANCHO DE LA BATERIA DE CALZADO (parte superior) = 1,40 m.
- ALTURA DE LA BATERIA DE CALZADO (parte superior) = 2,60 m.

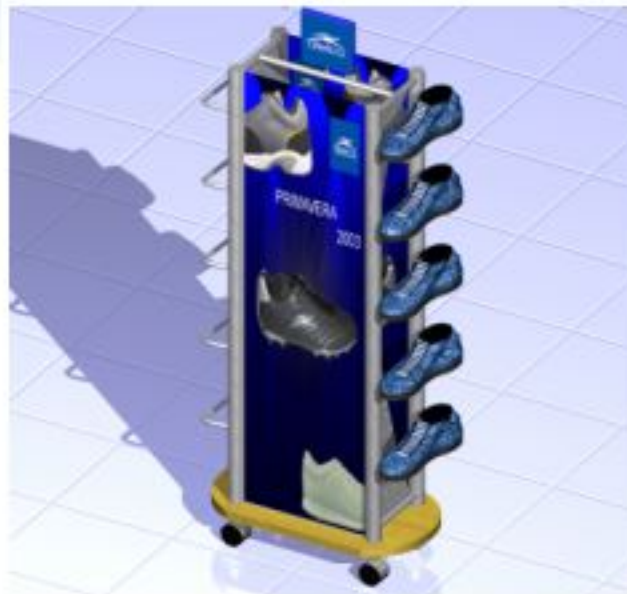
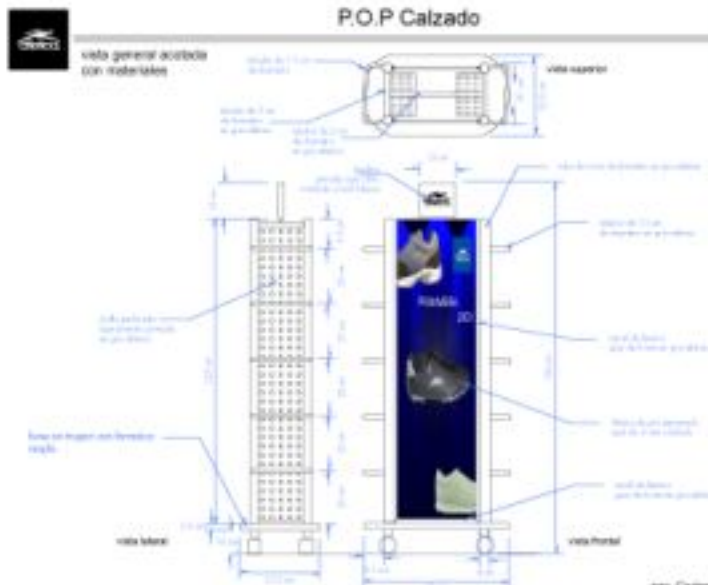
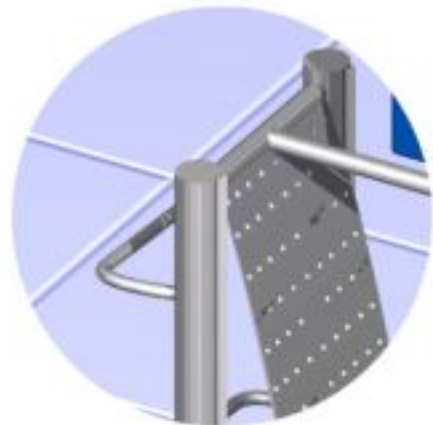
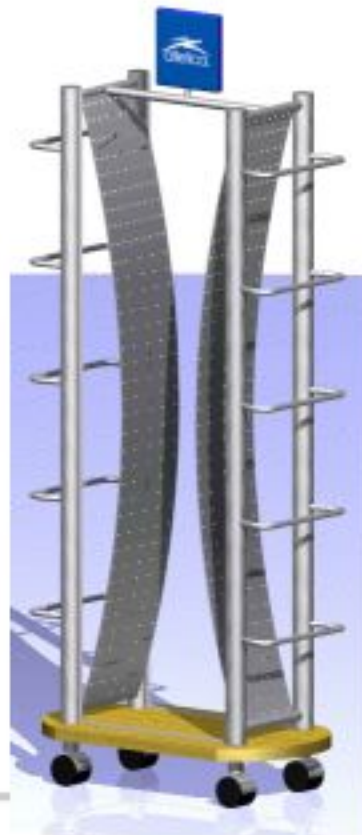
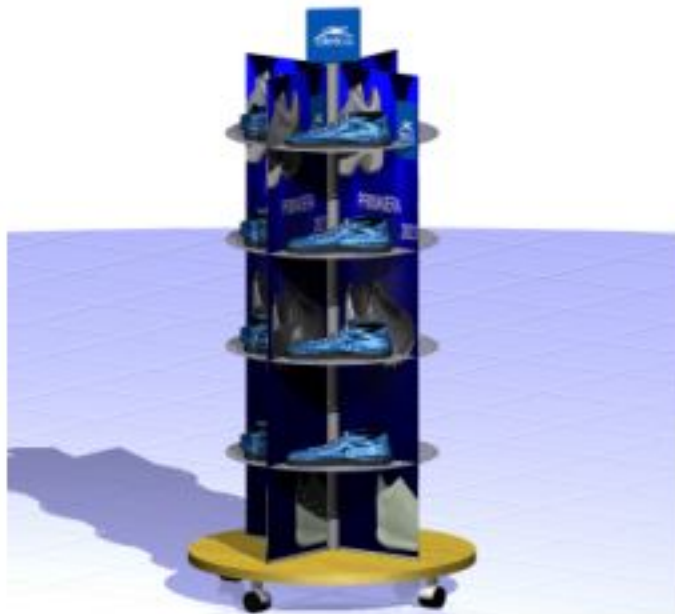



perspectiva montado en el muro



gráfico
1m de base x .81m

perspectivas

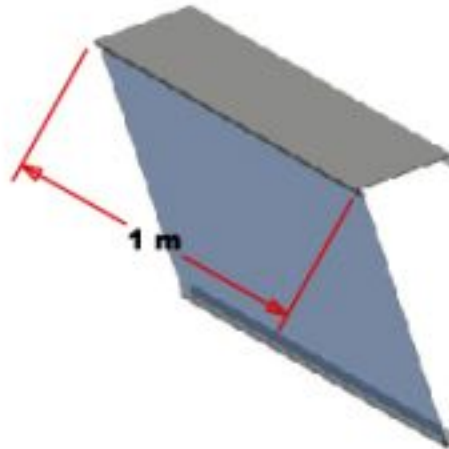

1 m

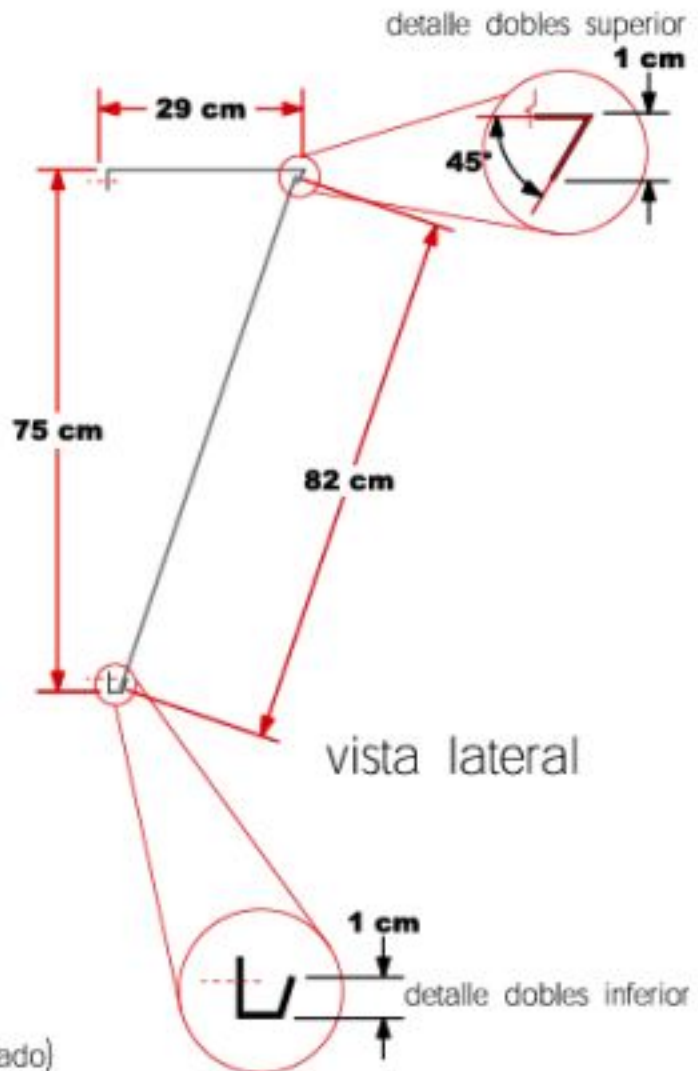

detalle dobles superior

1 cm

29 cm

45°

75 cm

82 cm

vista lateral

1 cm

detalle dobles inferior

laminas dobladas
terminado gris (electropintado)
con anclaje para muro (firme o tablarroca)

PORTA POSTERS (PARA PANEL RANURADO)



PORTA POSTERS (PARA CREMALLERAS)

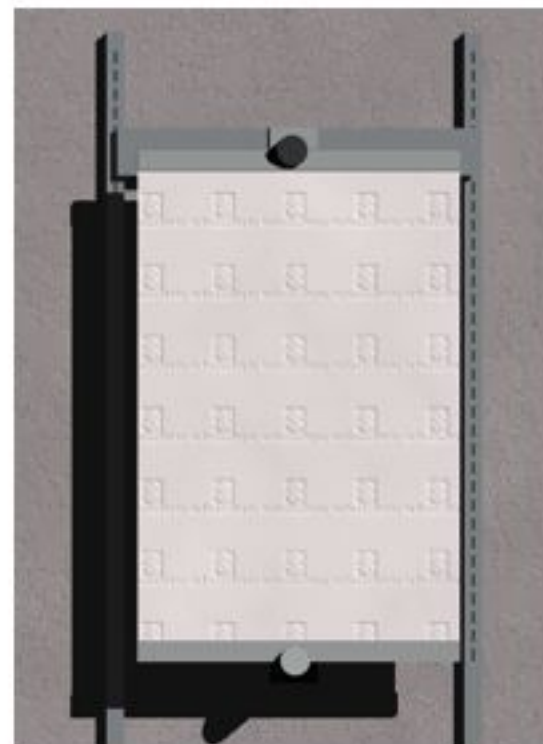
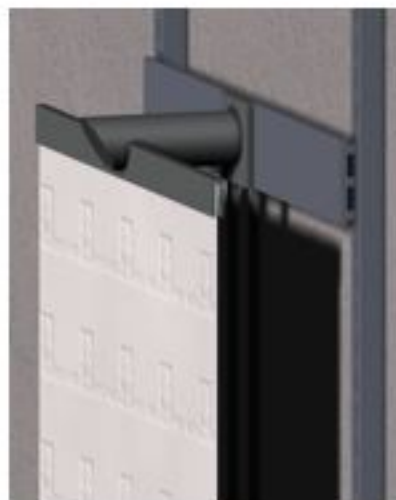

MODELOS EXPERIMENTALES Y DISEÑO DE PRODUCTOS

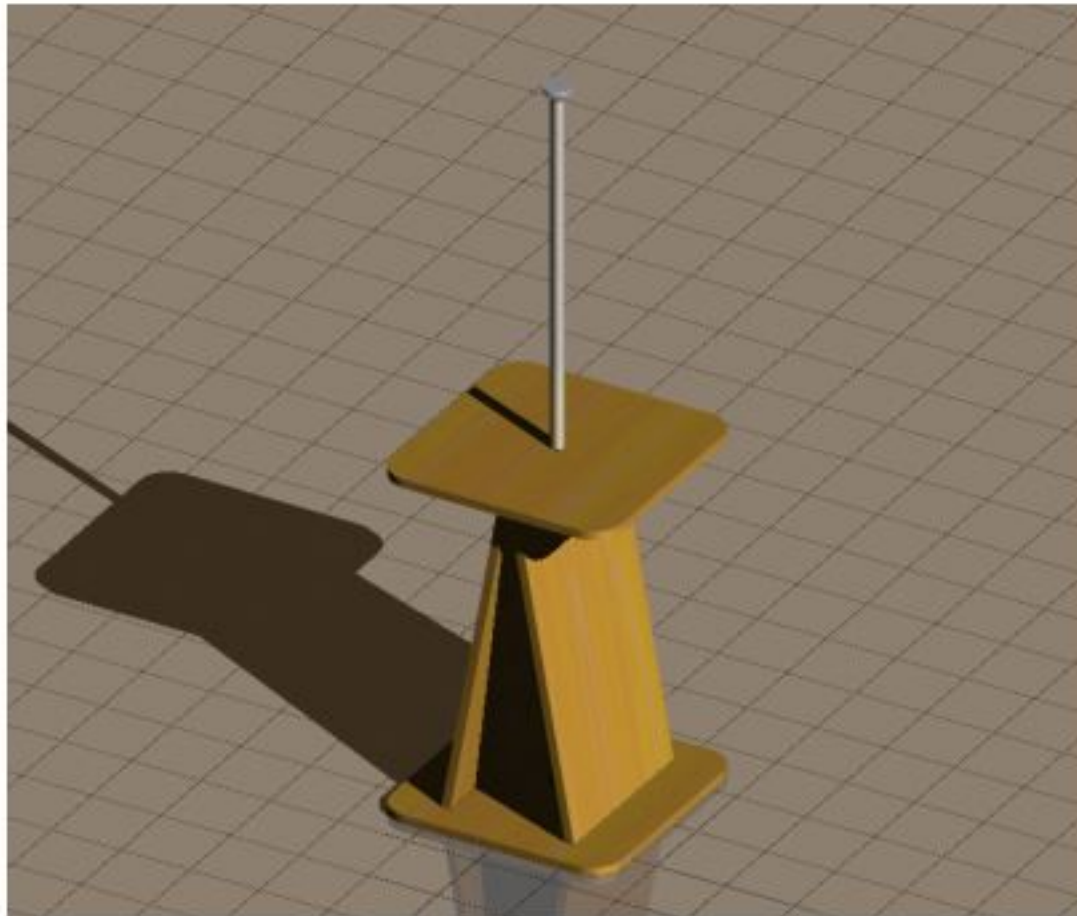

PROYECTO DE UN BUROE DE BAJO COSTO

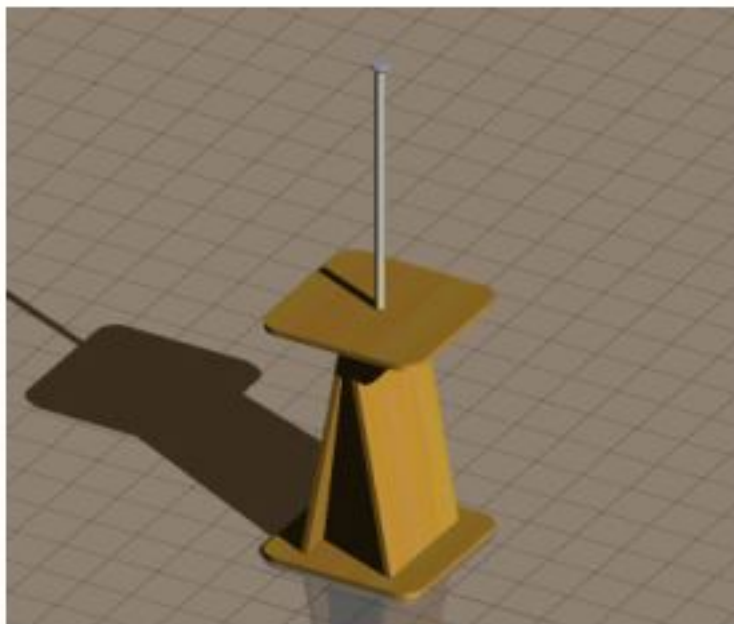

PROYECTO DE IMAGEN PARA MERMELADA

PROPUESTA SEPTIEMBRE -05

CLIENTE: INDUSTRIALIZADORA LORO
 NUEVA ETIQUETA PARA LINEA DE MERMELADAS ANI
 NUEVA IMAGEN / NUEVO LOGOTIPO



PROYECTO DE PORTA GARRAFONES PARA AGUA SANTORINI

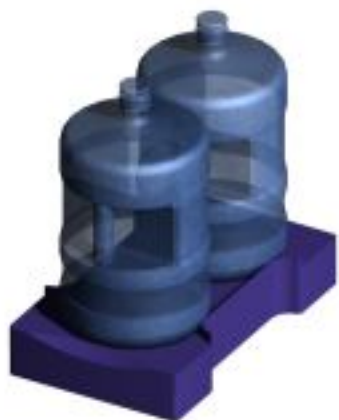

PROYECTO DE UNA LAMPARA DE LUZ INDIRECTA

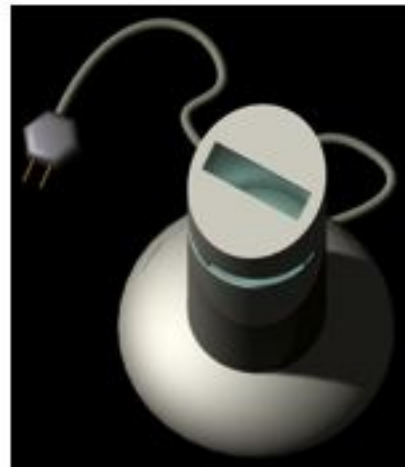
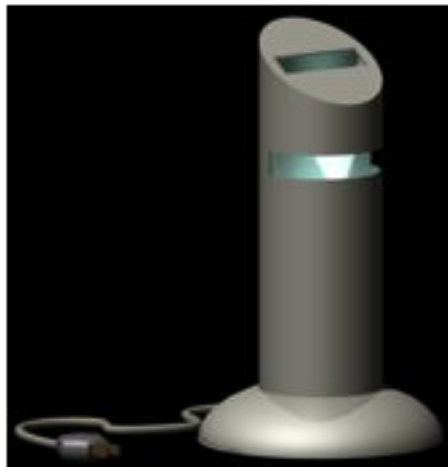
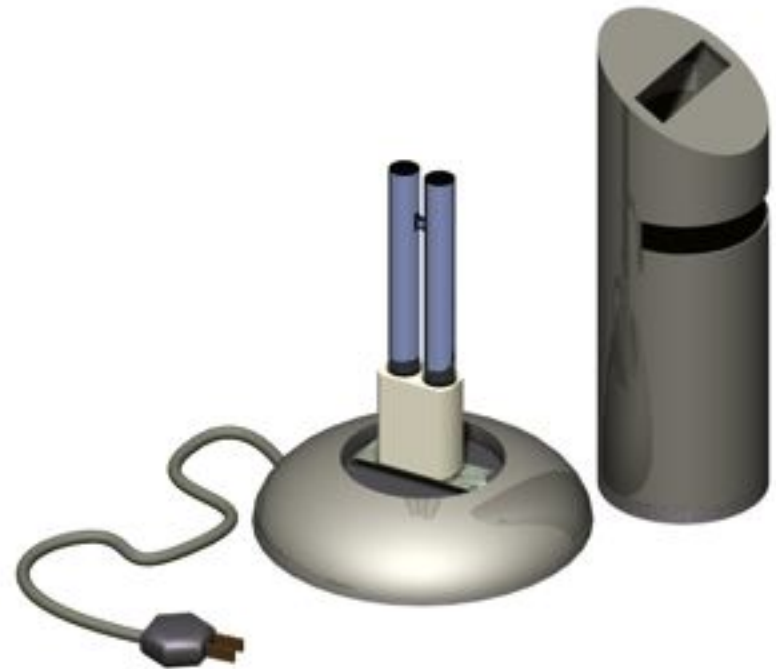
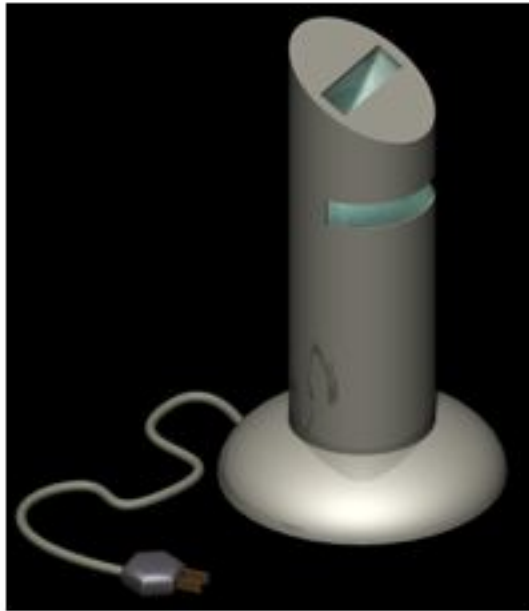

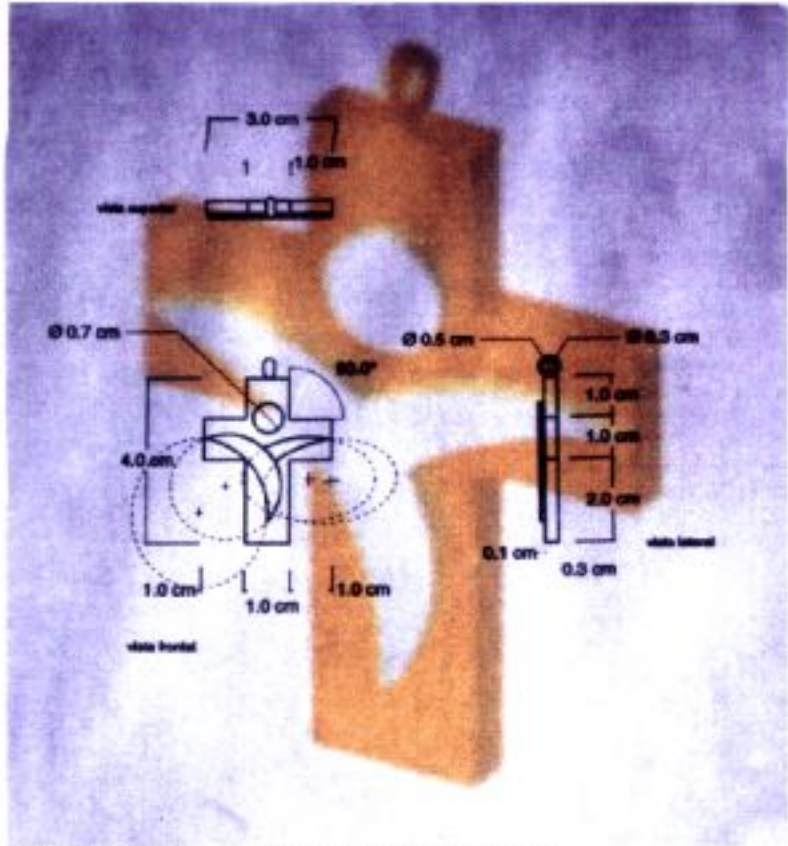

Premio especial, II Muestra de diseño, Carlos Gutiérrez Medrano
 Special award, II Design Exhibit, Carlos Gutiérrez Medrano.

JOYA

 2000

Nuestra JOYA



Diseño

Año 18 No. 76 Octubre 2000, Revista bilingüe / Bilingual magazine







OLIMPICOS *de* ATENAS 2004



www.athens2004.com



propuestas

línea gimnasia artística 2004

OLIMPICOS ATENAS



plata/rosa/mar/verde

rosa/mar/leño/blanco/verde

Linea Gimnasia Artística 2004 OLIMPICOS ATENAS

COLORES METALICOS Y TORNASQUES COMBINADOS CON LISOS Y ADORNADOS CON FIGURAS DE FANTASIA

COMPETENCIA



Señales y logotipos del Comité Olímpico Internacional y del Comité Olímpico de España

ENTRENAMIENTO

COLORES METALICOS Y TORNASQUES COMBINADOS CON LISOS





by Carlos Gutiérrez

ARCHIVO PARA MANDAR

 **línea ciclismo 2004 OLIMPICOS ATENAS**

guantes
NANCY CONTRERAS 

- 213C 
- 212C 

CONSTRUCCION TIPO GUAANTE DE GOLF

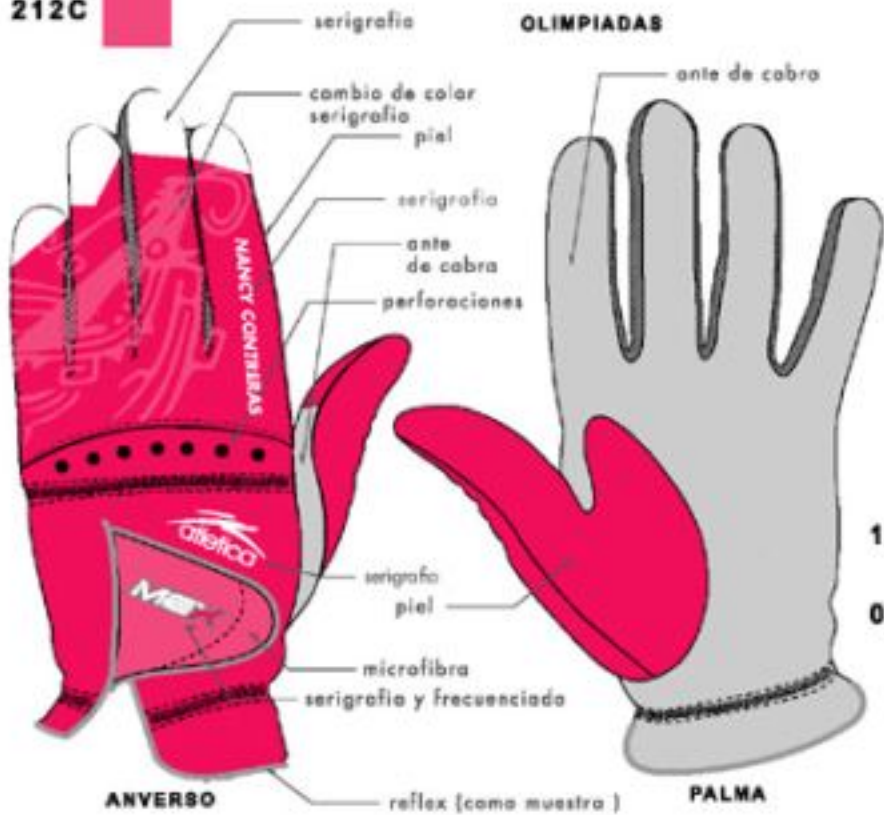



GRAFICOS

NANCY CONTRERAS
futura / bold obliquo

MEX
MEX



CAMPEONATOS MUNDIALES

- 185C 
- 032C 



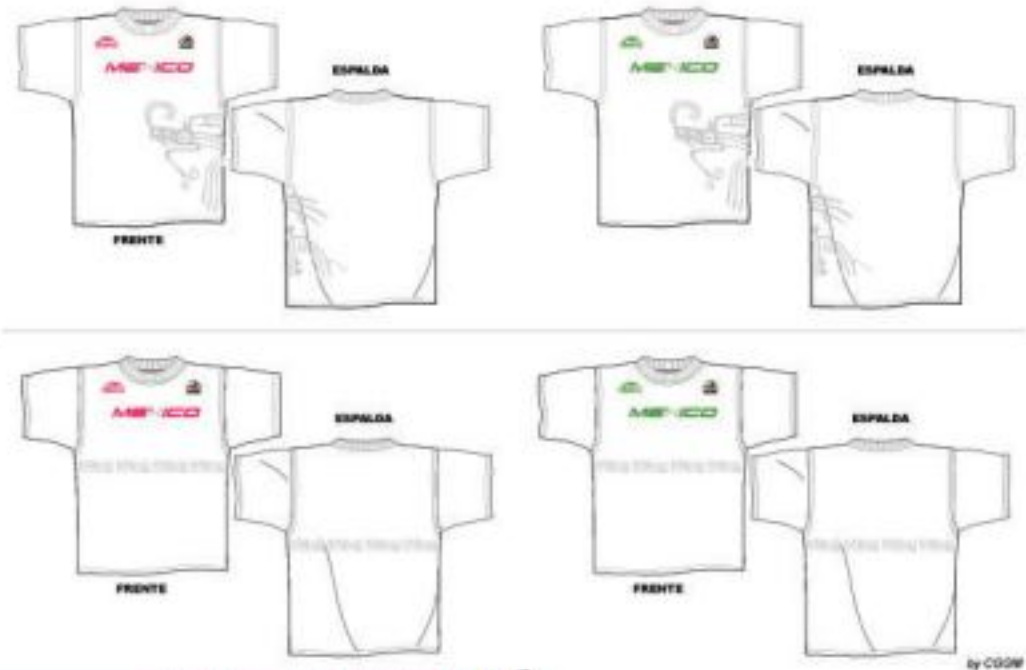

by COGW

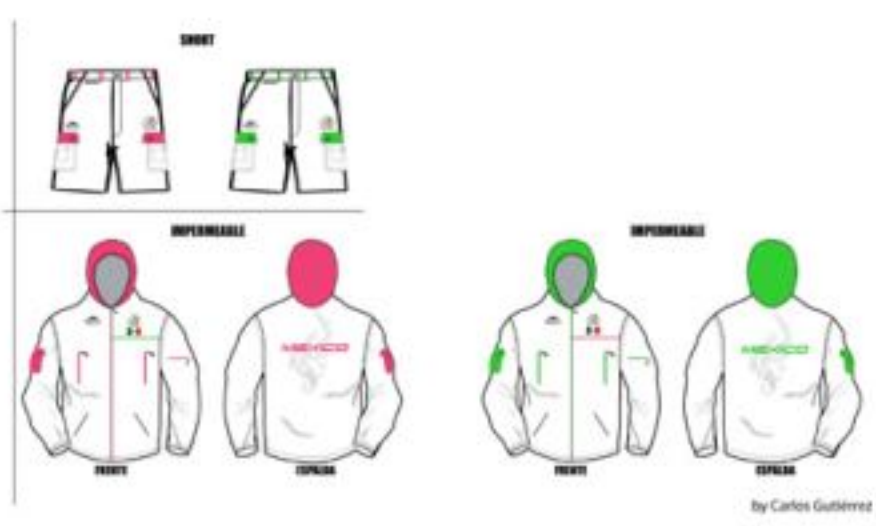

By Carlos Gutierrez

Carlos G. Gutiérrez Medrano

- Nacido el 11 de octubre 1966 Cd.de México
- Lic. En Diseño Industrial gen.1992 U.A.G
- Experiencia profesional en:
- Estands para expos, p.o.p, mobiliario, joyeria, calzado, accesorios, textiles, graficos.
- Manejo de sistemas mac y pc , paqueteria de diseño incluida 3D
- Tecnico mecanico en unidades a gasolina
- Feliz mente casado con dos hijas