

Enamel fill  
reference sample  
sent to WOOSTER  
2/15/19  
via UPS #1Z98E9E40493973633

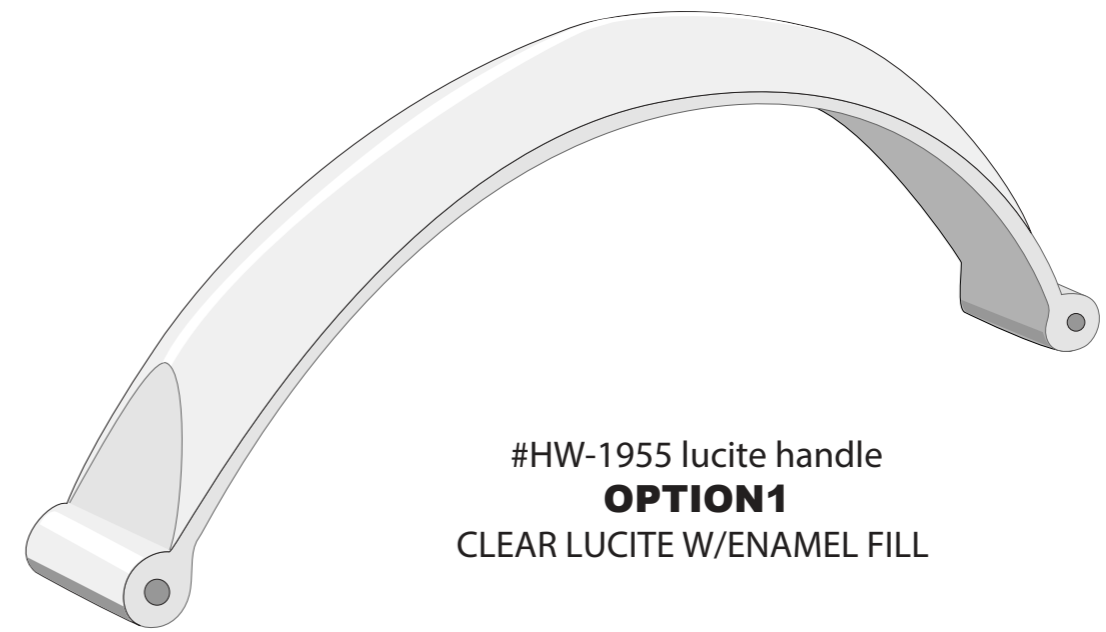

PLEASE STUDY  
REFERENCE SAMPLE  
AND **ADVISE**  
**IF ANY DIFFICULTY**  
**TO DEVELOPE**



#HW-1955 lucite handle  
**OPTION1**  
CLEAR LUCITE W/ENAMEL FILL

## CLEAR LUCITE HANDLE

Please make sure to finish all  
edge / corners round and smooth

### FRONT AND BACK VIEW

### SIDE VIEW

### SIDE CROSS SECTION VIEW

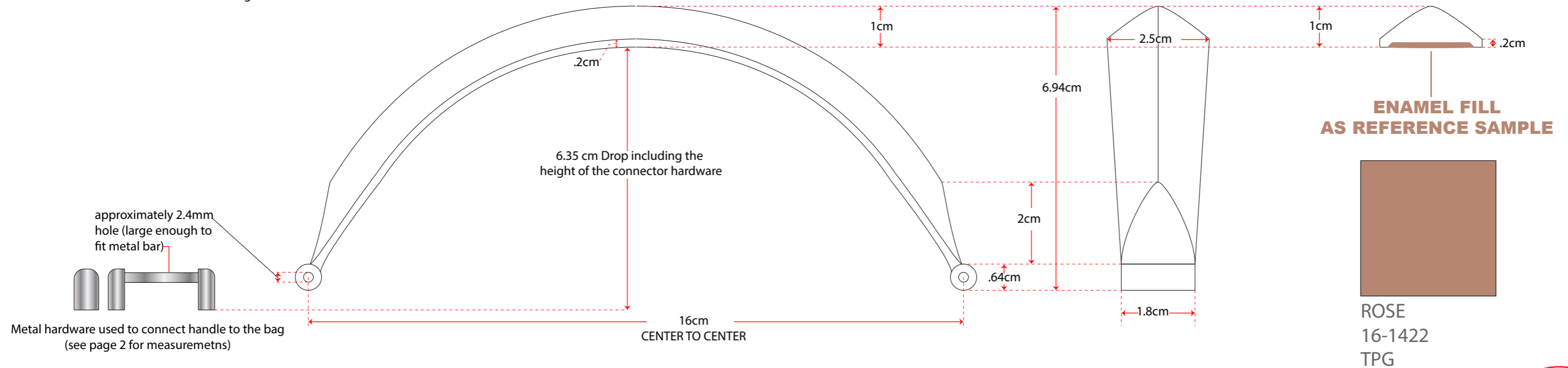

## 3 PIECE METAL CONNECTORS

The hardware seperates  
so the lucite handle can  
be placed on it

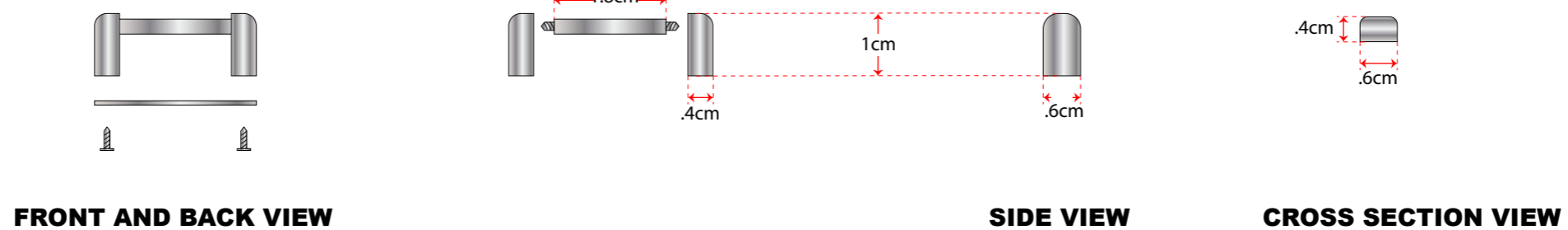

100%  
TO  
SCALE

**LAYERED LUCITE  
REFERENCE IMAGE  
(LAYER CONSTRUCTION  
REFERENCE ONLY)**

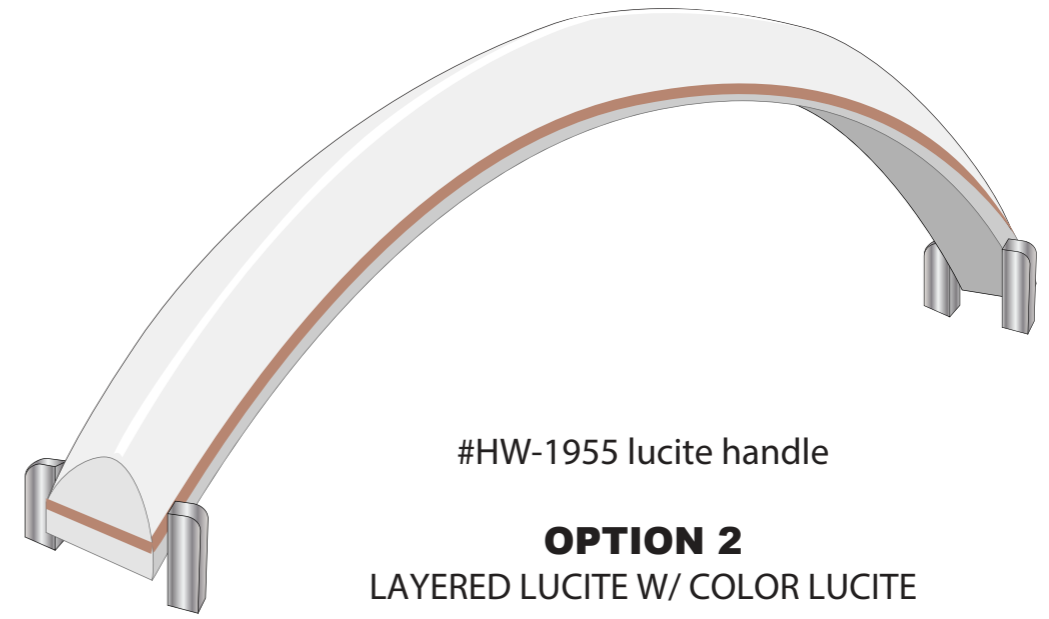

#HW-1955 lucite handle

**OPTION 2  
LAYERED LUCITE W/ COLOR LUCITE**

CLEAR LUCITE HANDLE

FRONT AND BACK VIEW

SIDE VIEW

SIDE CROSS SECTION VIEW

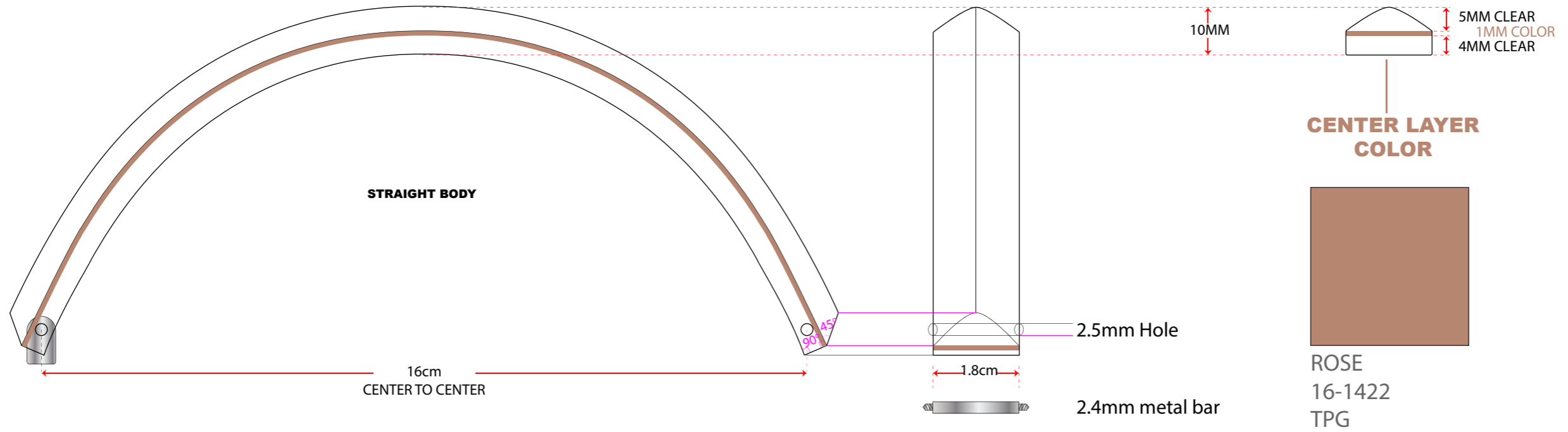

3 PIECE METAL CONNECTORS

The hardware separates  
so the lucite handle can  
be placed on it

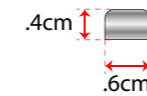
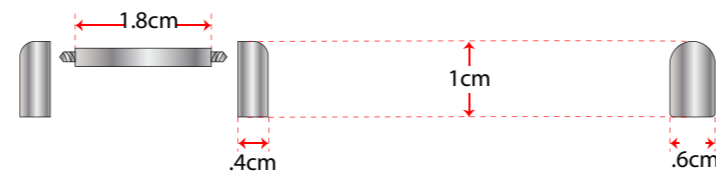
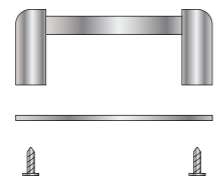

FRONT AND BACK VIEW

SIDE VIEW

CROSS SECTION VIEW

100%  
TO  
SCALE